

[www.centralsurgical.com](http://www.centralsurgical.com)

# Dental Instruments Catalogue



SIALKOT - PAKISTAN.



# Index

1. Tooth Extracting Forcep
2. Root Elevator
3. Scalpel Handles, Handles, Mouth Mirrors  
Scalers, Explorer / Probes
4. Endodontic Condensers, Obturation Instruments  
Excavators, Explorer / Probes, Curette Sets
5. Amalgam Plugger / Condensers, Burnishers
6. Wax Carvers, Carvers, Chisels
7. Composite Placement, Plastic Filling Instruments
8. Curettes, Gracey Curettes, Dental Products, Knives
9. Wax Porcelain & Cement Instruments  
Wax & Modeling Instruments
10. Spatulas, Cement Spatulas
11. Files, Hoes, Knives Wax & Plaster Knives  
Crane Kaplan
12. Bone Curettes, Bone Files, Bone Chisels,  
Bone Mallets
13. Crown Removers, Crown Instruments

14. Implants & Measuring Instruments, Suction Tubes, Bone Gauges
15. Amalgam Guns & Carriers, Retainers, Bands, Strip Holders, Napkin Holders
16. Rubber Dam Instruments, Rubber Dam Clamps
17. Syringes, Tweezers, Sterilizing & Lab Instruments
18. Endodontic Forceps, Tissue Forceps, Haemostatic Forceps, Towel Clamps
19. Retractors, Lip & Cheek Retractors, Hooks, Depressors & Mouth Gags, Sterilizing Forceps
20. Orthodontic Pliers & Cutters, Rongeurs
21. Needle Holders, Scissors, Micro Surgery Set
22. Impression Trays
23. Articulators, Hollow Wares
24. Scissors, Dissecting Forceps, Needle Holders, Wire Cutting Pliers With Tungsten Carbide Inserts
25. Paramedic / Utility / EMT Shear
26. Key Ring

# SELECT THE HANDLE STYLE

1. Larning Handle



2. Plain Handle



3. Grip Handle



4. Finger Handle



5. Holes Handle



6. Diamond Coated Forceps



## EXTRACTING FORCEPS

### ENGLISH PATTERN



**1001**  
Fig. 4  
lower incisor



**1001**  
Fig. 4  
lower incisor



**1002**  
Fig. 8  
lower premolar



**1002**  
Fig. 8  
lower premolars

# EXTRACTING FORCEPS

## ENGLISH PATTERN



**1003**  
Fig. 1  
upper centrals & canines



**1004**  
Fig. 2  
upper laterals & canines



**1005**  
Fig. 3  
upper incisors & canines



**1006**  
Fig. 4  
upper incisors & canines



**1007**  
Fig. 7  
upper premolars



**1008**  
Fig. 8  
lower premolars

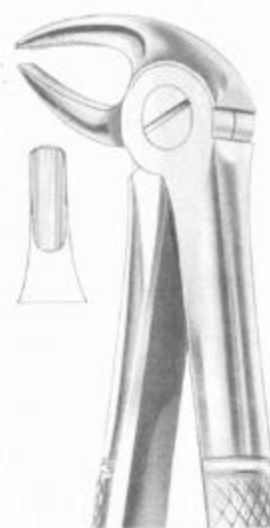

**1009**  
Fig. 13  
lower premolars

# EXTRACTING FORCEPS

## ENGLISH PATTERN



**1010**  
Fig. 13S  
lower premolars  
for children.

**1011**  
Fig. 17  
upper molars, right

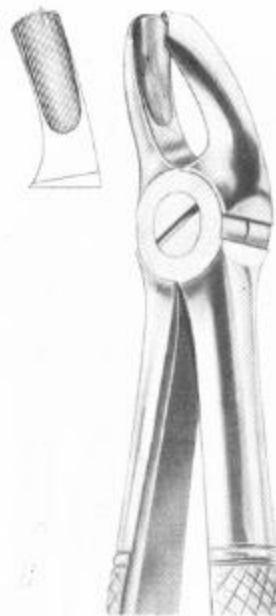

**1012**  
Fig. 18  
upper molars, left

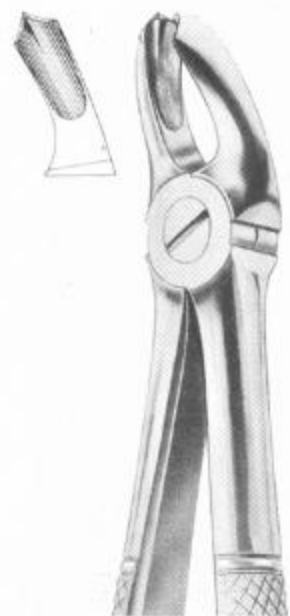

**1013**  
Fig. 18A  
upper molars

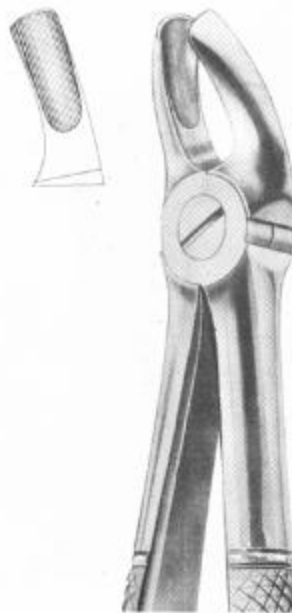

**1014**  
Fig. 18B  
upper molars



**1015**  
Fig. 19  
upper third molars

# EXTRACTING FORCEPS

## ENGLISH PATTERN



**1016**  
Fig. 20  
upper third molars

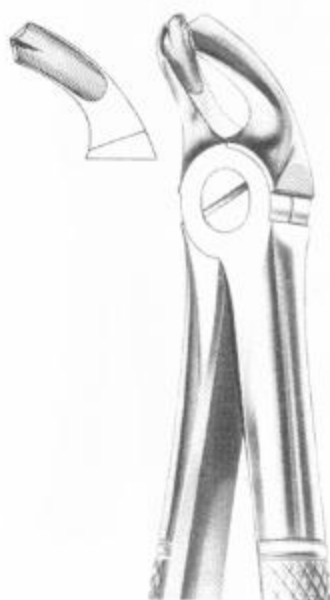

**1017**  
Fig. 21  
lower molars



**1018**  
Fig. 22  
lower molars

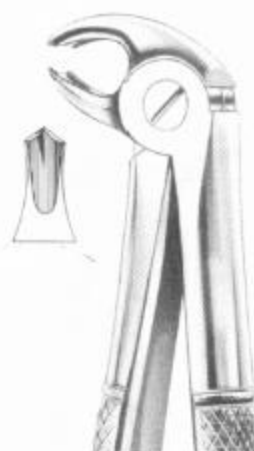

**1019**  
Fig. 22S  
lower molars  
for children

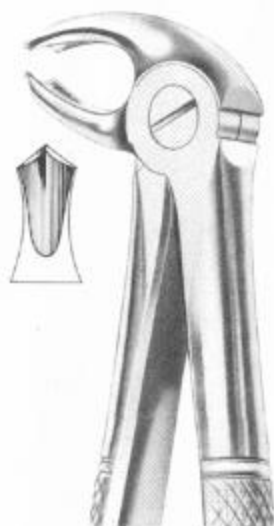

**1020**  
Fig. 22G  
lower molars



**1021**  
Fig. 23  
lower molars right

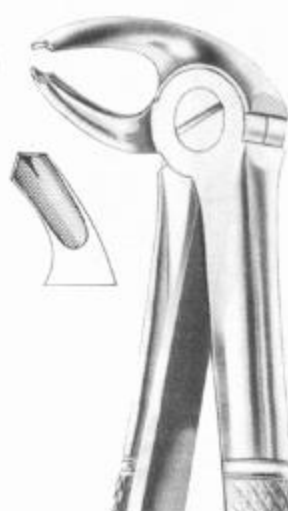

**1022**  
Fig. 24  
lower molars left



# EXTRACTING FORCEPS

## ENGLISH PATTERN



**1023**  
Fig. 29  
upper roots



**1024**  
Fig. 29S  
upper roots for children



**1025**  
Fig. 30  
upper roots

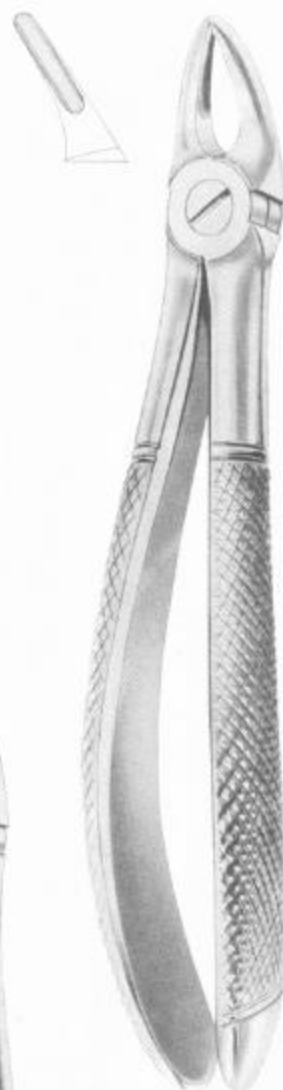

**1028**  
Fig. 30S  
upper roots for children

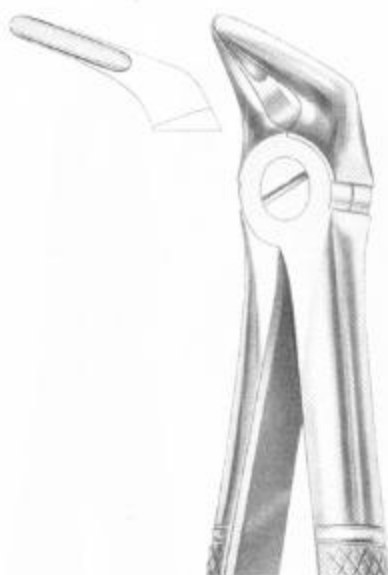

**1026**  
Fig. 31  
lower roots



**1027**  
Fig. 32  
lower molars

# EXTRACTING FORCEPS

## ENGLISH PATTERN



**1029**  
Fig. 33  
lower roots

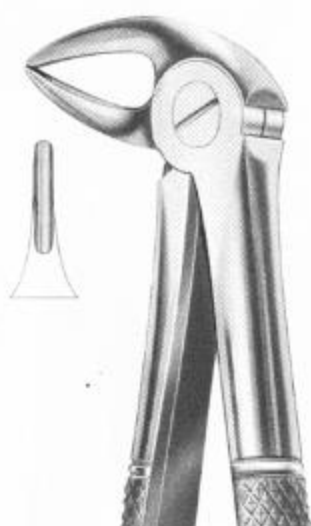

**1030**  
Fig. 33A  
lower roots

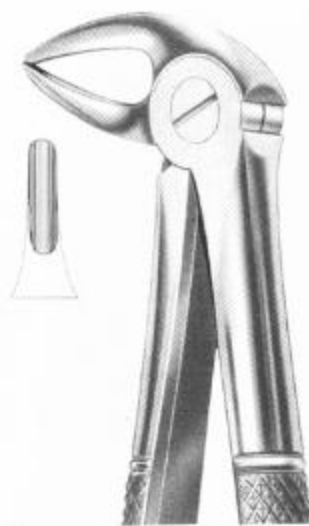

**1031**  
Fig. 33B  
lower roots

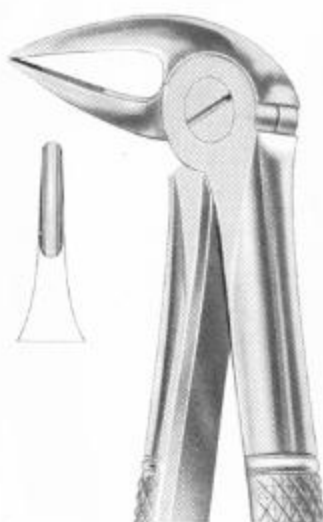

**1032**  
Fig. 33L  
lower roots



**1033**  
Fig. 37  
upper incisors  
for children



**1034**  
Fig. 33S  
lower roots  
for children

# EXTRACTING FORCEPS

## ENGLISH PATTERN



**1035**  
Fig. 38  
lower incisors &  
canines for children

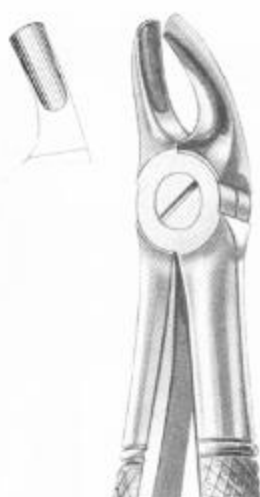

**1036**  
Fig. 39  
upper molars  
for children



**1037**  
Fig. 39R  
upper molars right  
for children



**1038**  
Fig. 39A  
upper molars  
for children

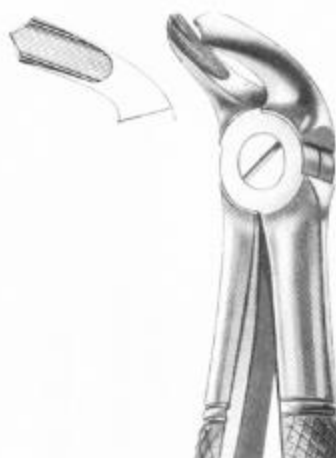

**1039**  
Fig. 40  
lower molars  
for children



**1040**  
Fig. 39L  
upper molars left  
for children

# EXTRACTING FORCEPS

## ENGLISH PATTERN



**1041**  
Fig. 41  
upper roots



**1042**  
Fig. 44  
upper roots



**1043**  
Fig. 45  
lower roots

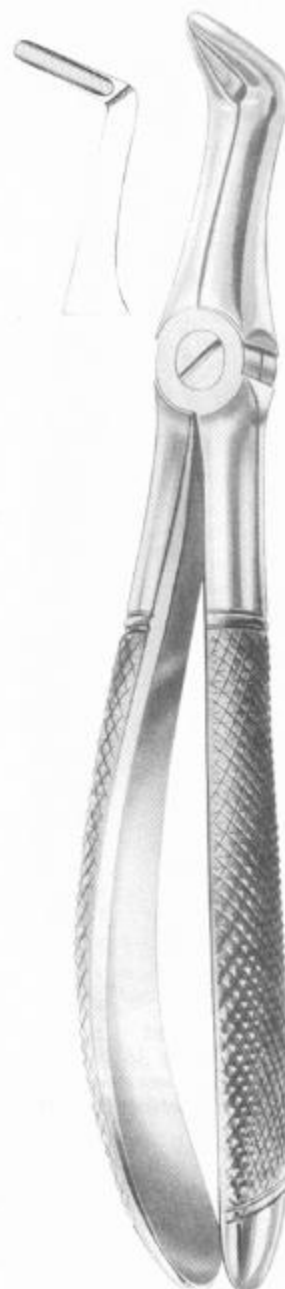

**1046**  
Fig. 50  
upper roots



**1044**  
Fig. 48  
lower roots



**1045**  
Fig. 49  
upper roots

# EXTRACTING FORCEPS

## ENGLISH PATTERN



**1047**  
Fig. 51  
upper roots



**1048**  
Fig. 51A  
upper roots



**1049**  
Fig. 51L  
upper roots



**1052**  
Fig. 51S  
upper roots  
for children

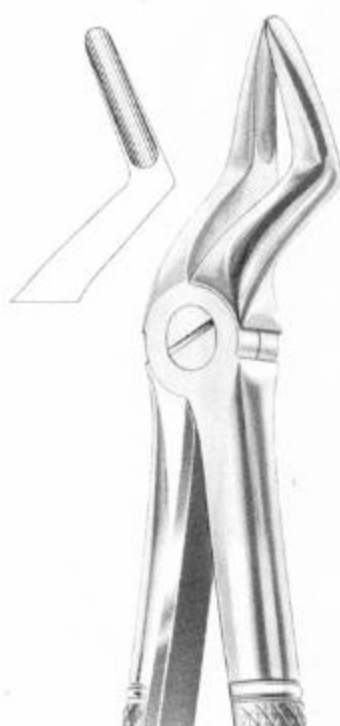

**1050**  
Fig. 52  
upper roots

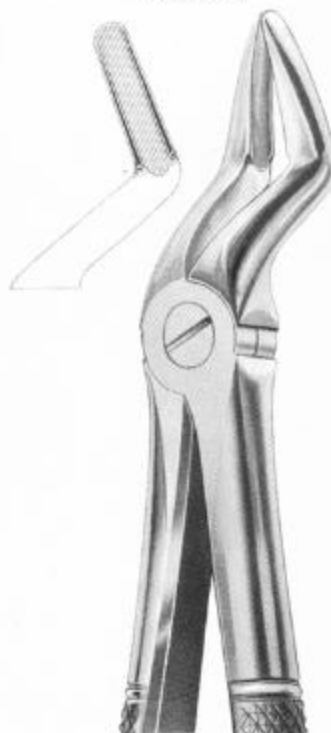

**1051**  
Fig. 52A  
upper teeth  
and resection

# EXTRACTING FORCEPS

## ENGLISH PATTERN



**1053**  
Fig. 54  
for separating  
upper molars

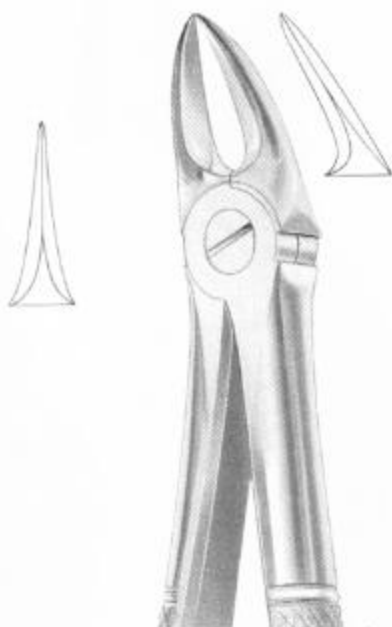

**1054**  
Fig. 55  
for separating  
upper molars



**1055**  
Fig. 56  
for separating  
lower molars

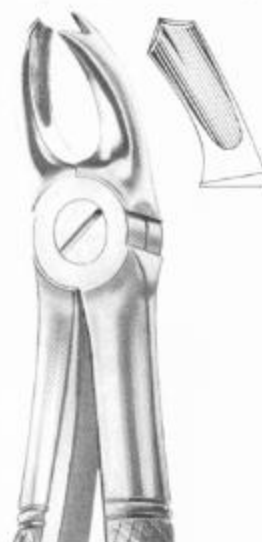

**1056**  
Fig. 65R  
upper molars  
right



**1057**  
Fig. 65L  
upper molars left

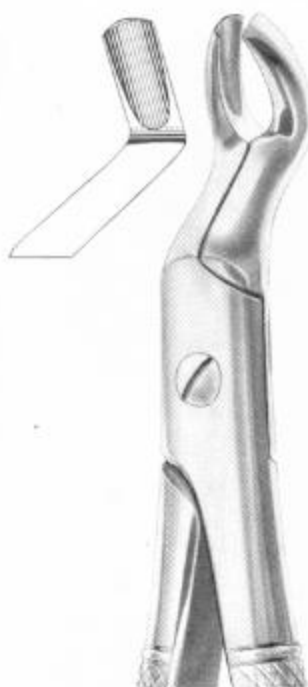

**1058**  
Fig. 67  
upper third molars



**1059**  
Fig. 67A  
upper third molars

# EXTRACTING FORCEPS

## ENGLISH PATTERN



**1060**  
Fig. 67 1/2R  
upper third molars  
right

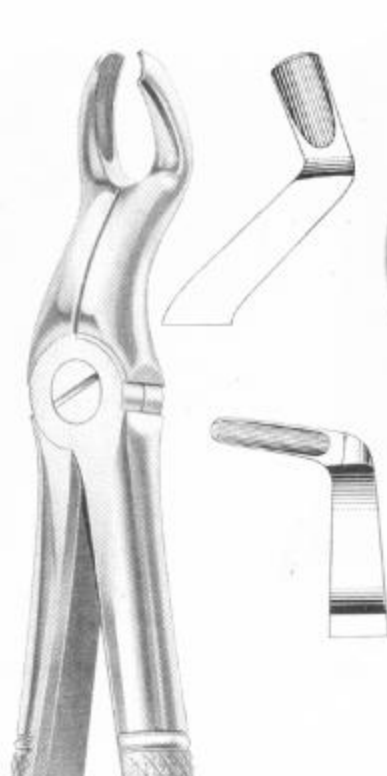

**1061**  
Fig. 67 1/2L  
upper third molars  
left



**1062**  
Fig. 68  
lower roots



**1063**  
Fig. 68A  
lower roots



**1064**  
Fig. 73  
lower molars



**1065**  
Fig. 73R  
lower molars right

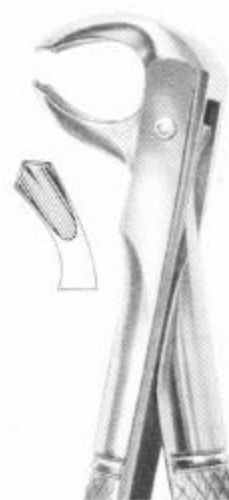

**1066**  
Fig. 73L  
lower molars left

# EXTRACTING FORCEPS

## ENGLISH PATTERN



**1067**  
Fig. 73A  
lower molars



**1068**  
Fig. 73S  
lower molars



**1069**  
Fig. 73B  
lower molars for children



**1072**  
Fig. 73K  
lower molars for children



**1070**  
Fig. 74  
lower roots



**1071**  
Fig. 74D  
lower roots



# EXTRACTING FORCEPS

## ENGLISH PATTERN



**1073**  
Fig. 74M  
lower roots

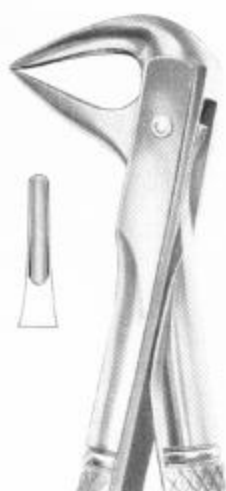

**1074**  
Fig. 74N  
lower roots

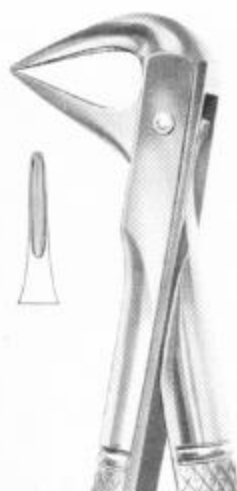

**1075**  
Fig. 74XN  
lower roots and  
crowded incisors

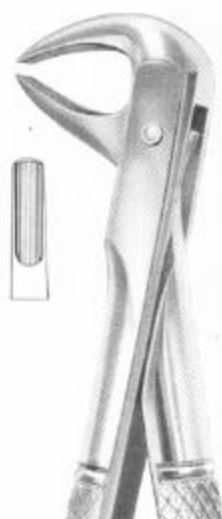

**1076**  
Fig. 75  
lower premolars



**1077**  
Fig. 76  
upper roots



**1078**  
Fig. 76N  
upper roots

## EXTRACTING FORCEPS

### ENGLISH PATTERN



**1079**  
Fig. 76S  
upper roots



**1080**  
Fig. 79  
lower third molars



**1081**  
Fig. 79A  
lower third molars



**1082**  
Fig. 81  
lower premolars  
and roots

# EXTRACTING FORCEPS

## ENGLISH PATTERN



**1083**  
Fig. 86A  
lower molars



**1084**  
Fig. 86B  
lower molars



**1085**  
Fig. 86C  
lower molars

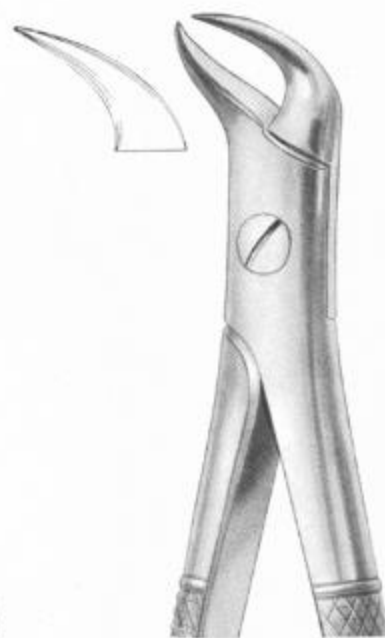

**1086**  
Fig. 87  
lower molars



**1087**  
Fig. 91  
for separating  
lower molars

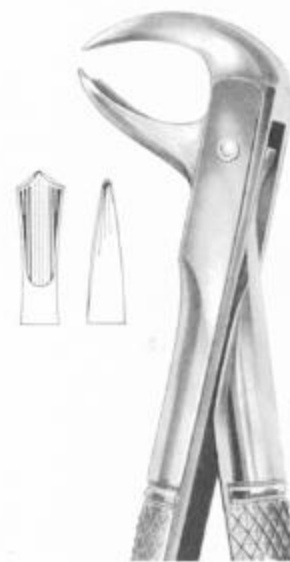

**1088**  
Fig. 99  
lower molars

## EXTRACTING FORCEPS

### ENGLISH PATTERN



**1089**  
Fig. 101  
upper premolars  
and roots



**1090**  
Fig. 100  
upper roots



**1091**  
Fig. 99 1/4  
lower molars



**1092**  
Fig. 99 1/2  
lower molars

# EXTRACTING FORCEPS

## ENGLISH PATTERN



**1093**  
Fig. 102  
upper molars right



**1094**  
Fig. 103  
upper molars left



**1095**  
Fig. 105  
lower incisors



**1096**  
Fig. 106  
lower incisors

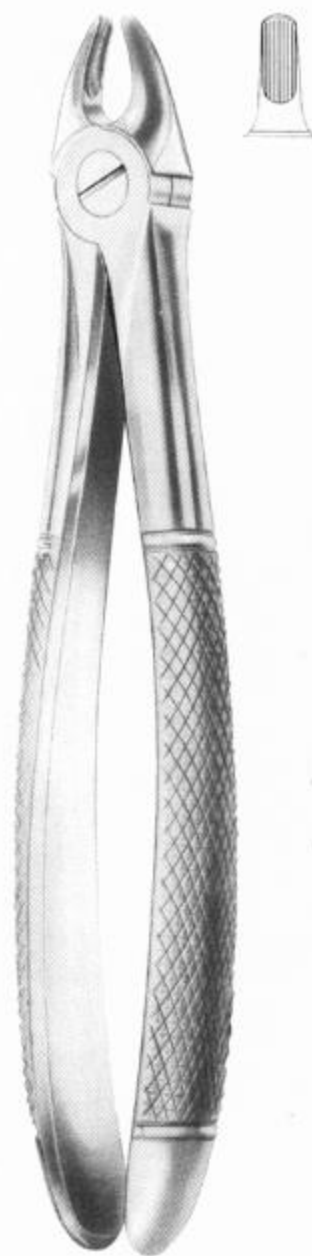

**1097**  
Fig. 103  
upper canines

# EXTRACTING FORCEPS

## ENGLISH PATTERN

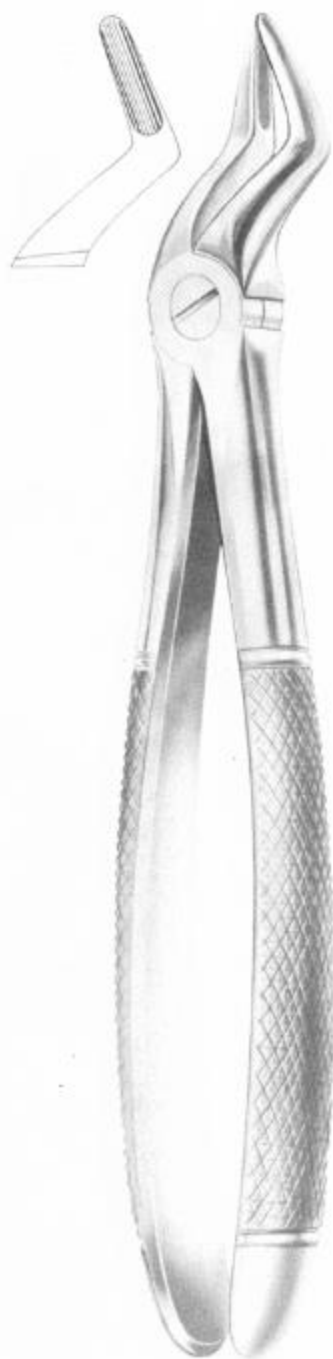

**1098**  
Fig. 112  
upper roots

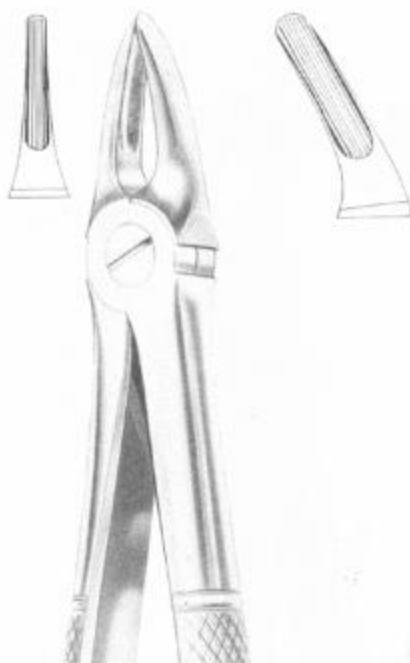

**1099**  
Fig. 113  
upper roots



**1101**  
Fig. 136  
upper premolars  
and roots



**1102**  
Fig. 137  
lower incisors  
and roots



**1100**  
Fig. 114  
upper roots



**1103**  
Fig. 143  
lower roots

# EXTRACTING FORCEPS

## ENGLISH PATTERN

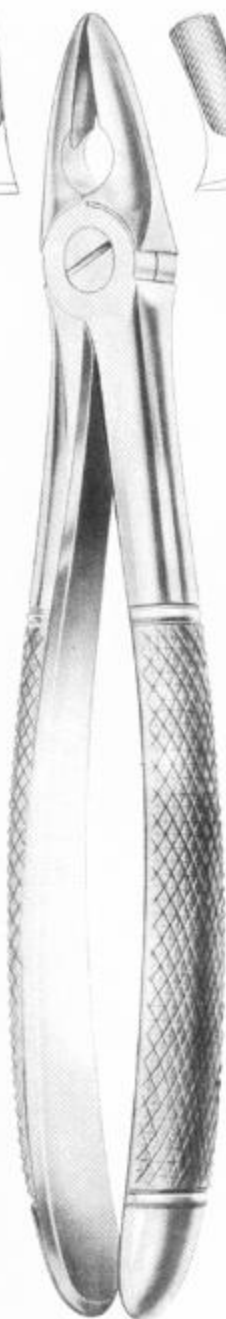

**1104**  
MEAD (MD 1)  
upper anteriors,  
roots, incisors, canines

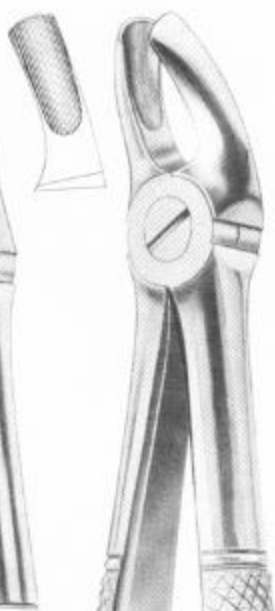

**1105**  
MEAD (MD 2)  
upper molars

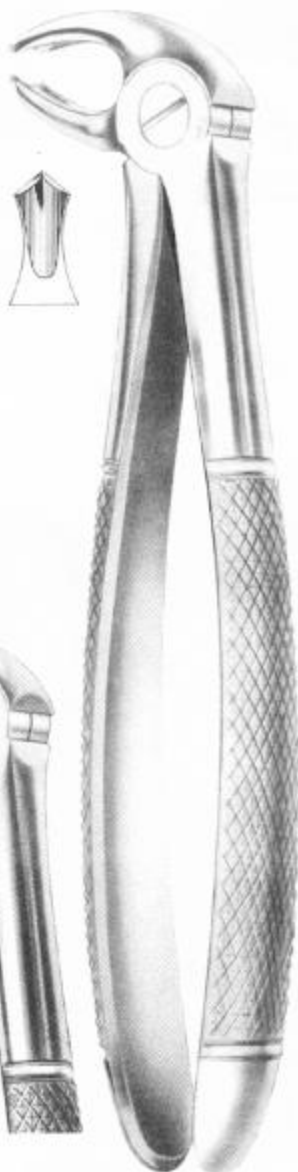

**1106**  
MEAD (MD 3)  
lower roots

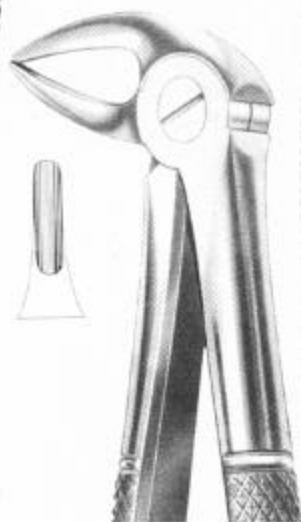

**1107**  
MEAD (MD 4)  
lower molars



**1108**  
FELSCH (Fig. 210)  
upper third molars



**1109**  
HERTZ (Fig. 211)  
lower incisors

# EXTRACTING FORCEPS

## ENGLISH PATTERN

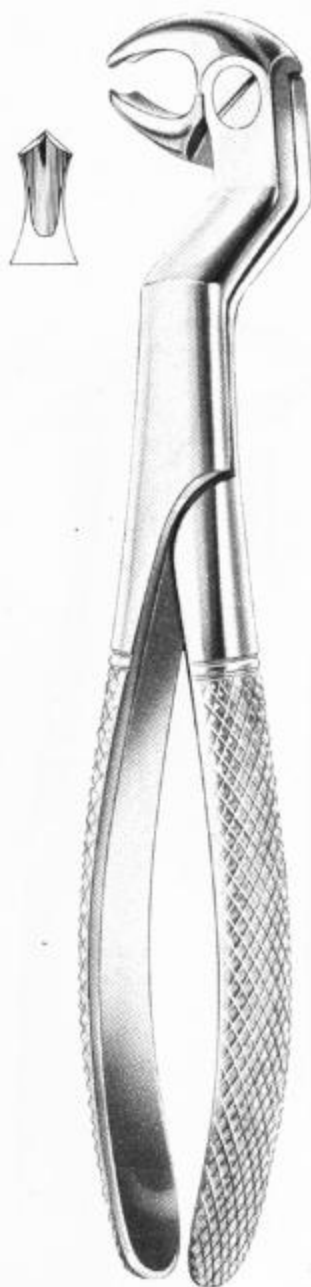

**1110**  
ROUTURIER (Fig. 212)  
(22 1/2 L)  
lower molars  
and wisdom left



**1111**  
ROUTURIER (Fig. 213)  
(22 1/2 R)  
lower molars  
and wisdom right



**1112**  
ROUTURIER (Fig. 214)  
(22 1/2 L)  
lower molars  
and wisdom left

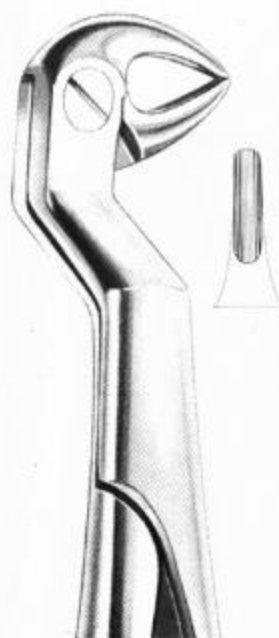

**1113**  
ROUTURIER (Fig. 215)  
(33 1/2 R)  
lower molars  
and wisdom right

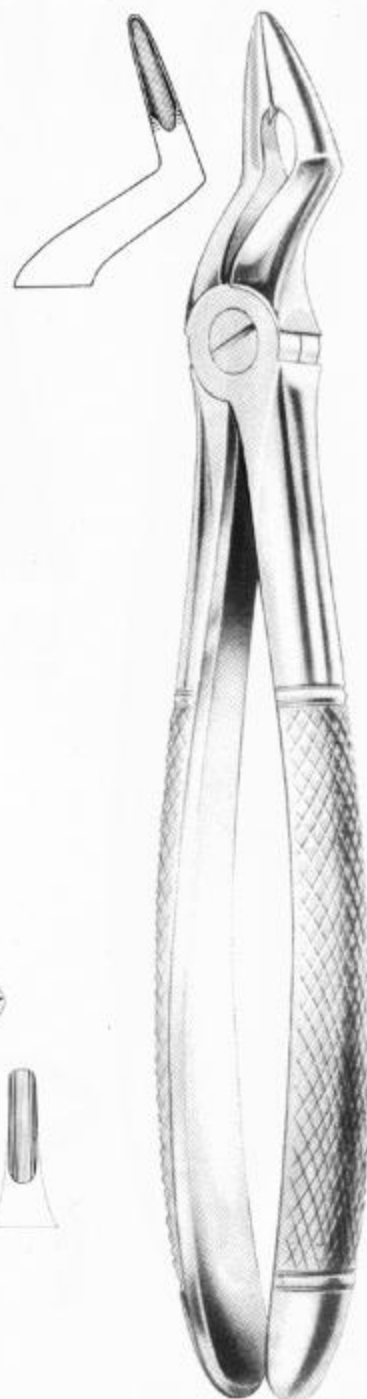

**1114**  
RESECTION FORCEPS  
(216/Witzel)  
upper roots



# EXTRACTING FORCEPS

## ENGLISH PATTERN



1115  
Fig. 5



1116  
Fig. 6



1117  
Fig. 9



1118  
Fig. 10



1119  
Fig. 11

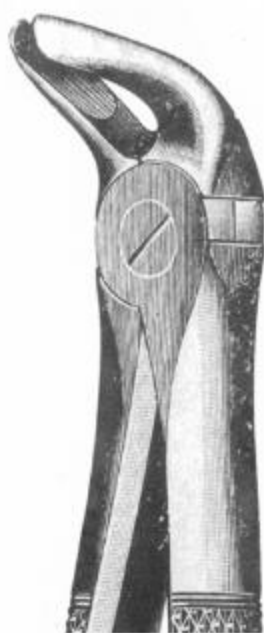

1120  
Fig. 12



1121  
Fig. 14



1122  
Fig. 15

# EXTRACTING FORCEPS

## ENGLISH PATTERN



1123  
Fig. 25



1124  
Fig. 26



1125  
Fig. 27



1126  
Fig. 28



1127  
Fig. 34



1128  
Fig. 35

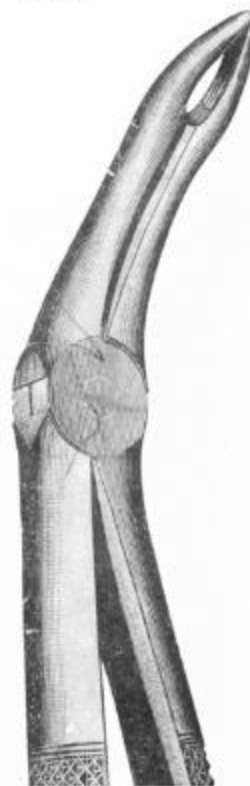

1129  
Fig. 42



1130  
Fig. 43

# EXTRACTING FORCEPS

## ENGLISH PATTERN



1131  
Fig. 44A



1132  
Fig. 46

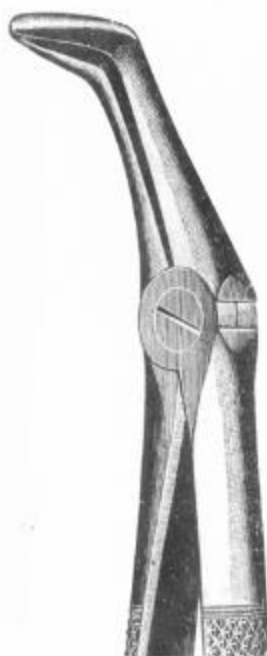

1133  
Fig. 47



1134  
Fig. 50A



1135  
Fig. 74R



1136  
Fig. 74L



1137  
Fig. 75R



1138  
Fig. 75L

# EXTRACTING FORCEPS

## ENGLISH PATTERN

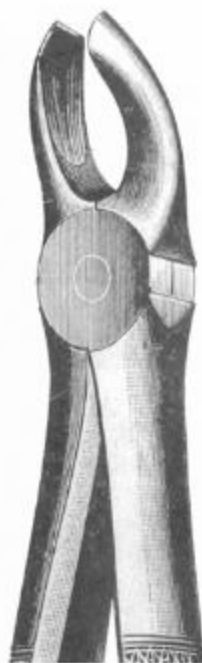

1139  
Fig. 94



1140  
Fig. 95



1141  
Fig. 98



1142  
Fig. 105



1143  
Fig. 106



1144  
Fig. 2002

## EXTRACTING FORCEPS

### WITH FITTING HANDLE

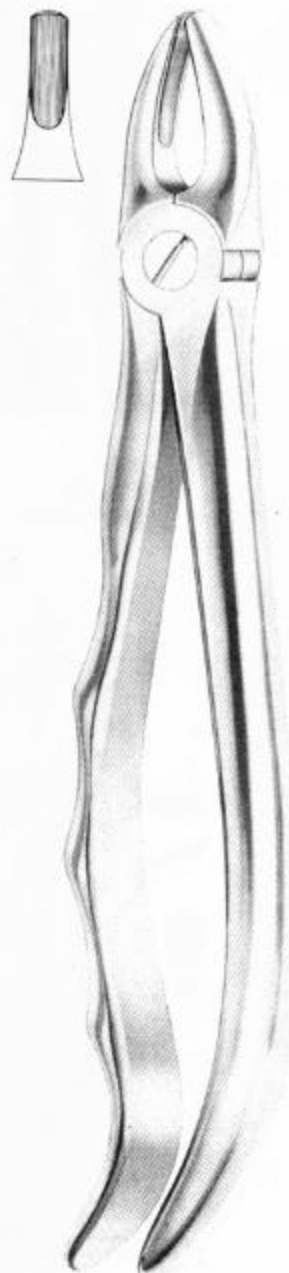

**1145**  
Fig. 1  
upper laterals  
and canines



**1146**  
Fig. 2  
upper laterals  
and canines



**1147**  
Fig. 3  
upper incisors  
and canines



**1148**  
Fig. 4  
lower incisors  
and canines



**1149**  
Fig. 7  
upper premolars

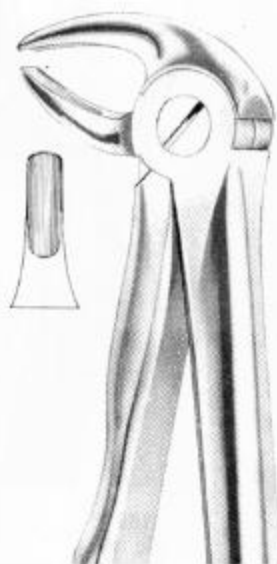

**1150**  
Fig. 13  
lower premolars

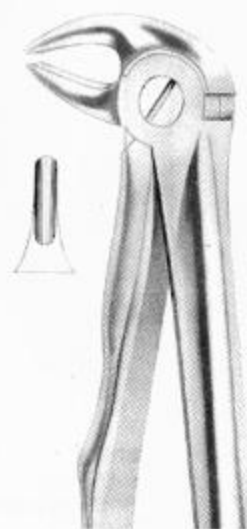

**1151**  
Fig. 13S  
lower premolars  
for children

# EXTRACTING FORCEPS

## WITH FITTING HANDLE

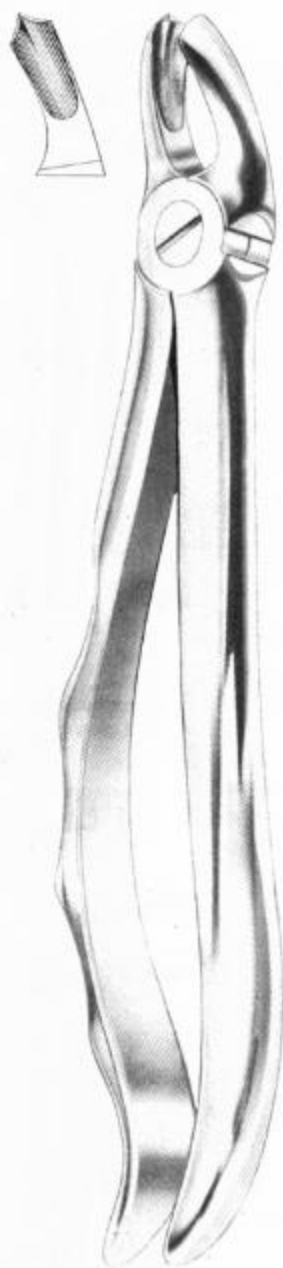

**1152**  
Fig. 17  
upper molars right



**1153**  
Fig. 18  
upper molars left

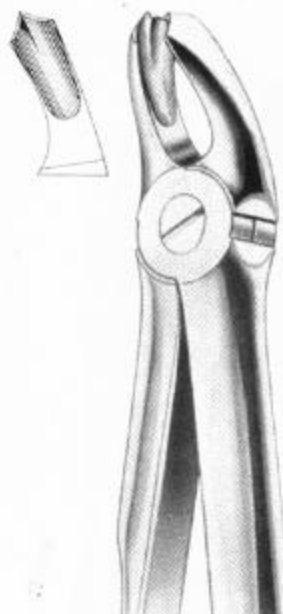

**1154**  
Fig. 18A  
upper molars



**1155**  
Fig. 18B  
upper molars



**1156**  
Fig. 19  
upper third molars



**1157**  
Fig. 22  
lower molars



**1158**  
Fig. 22S  
lower molars  
for children

## EXTRACTING FORCEPS

### WITH FITTING HANDLE



**1159**  
Fig. 29  
upper roots



**1160**  
Fig. 29S  
upper roots  
for children



**1161**  
Fig. 30  
upper roots

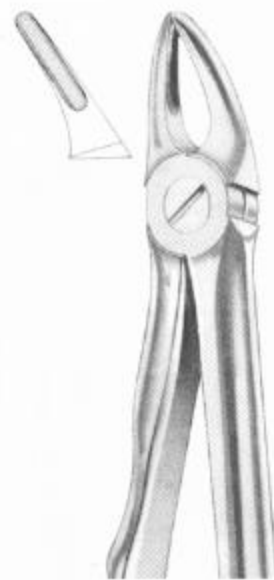

**1162**  
Fig. 30S  
upper roots  
for children



**1163**  
Fig. 33  
lower roots



**1164**  
Fig. 33A  
lower roots

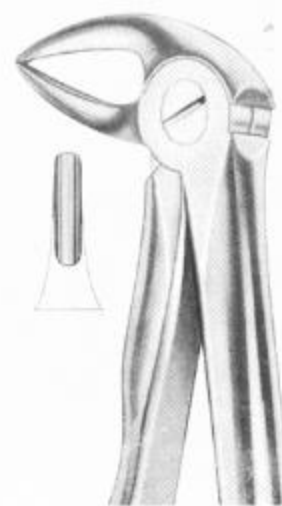

**1165**  
Fig. 33B  
lower roots

## EXTRACTING FORCEPS

### WITH FITTING HANDLE



**1166**  
Fig. 33L  
lower roots



**1167**  
Fig. 33S  
lower roots  
for children

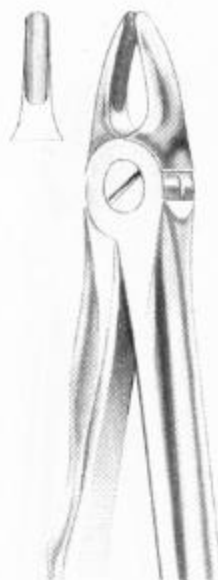

**1168**  
Fig. 37  
upper incisors  
for children



**1169**  
Fig. 39  
upper incisors  
for children



**1170**  
Fig. 39A  
upper molars  
for children



**1171**  
Fig. 39R  
upper molars right  
for children



**1172**  
Fig. 39L  
upper molars left  
for children



## EXTRACTING FORCEPS

### WITH FITTING HANDLE



**1173**  
Fig. 41  
upper roots

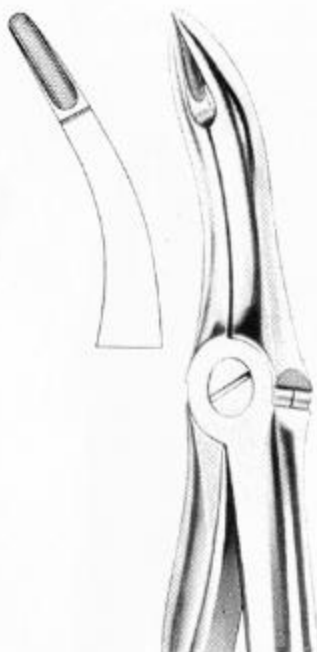

**1174**  
Fig. 44  
upper roots

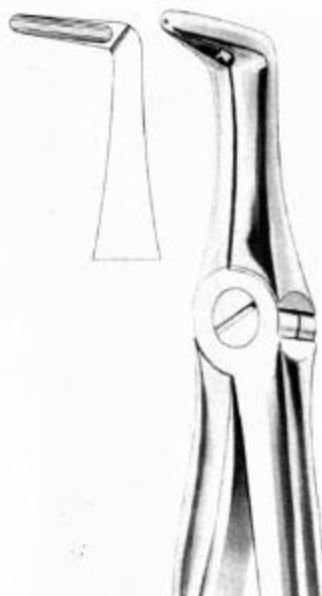

**1175**  
Fig. 45  
lower roots

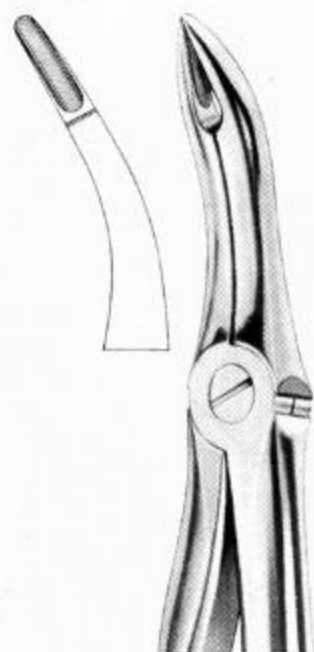

**1176**  
Fig. 48  
lower roots

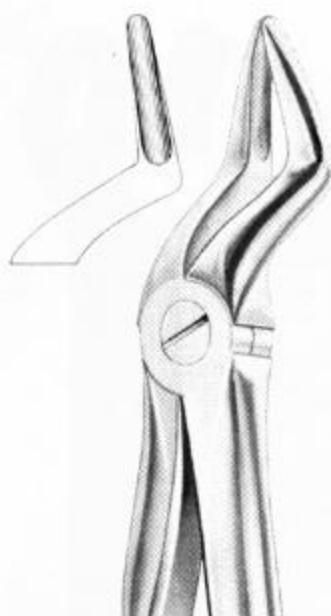

**1177**  
Fig. 51  
upper roots



**1178**  
Fig. 51A  
upper roots



**1179**  
Fig. 51S  
upper roots  
for children

## EXTRACTING FORCEPS

### WITH FITTING HANDLE

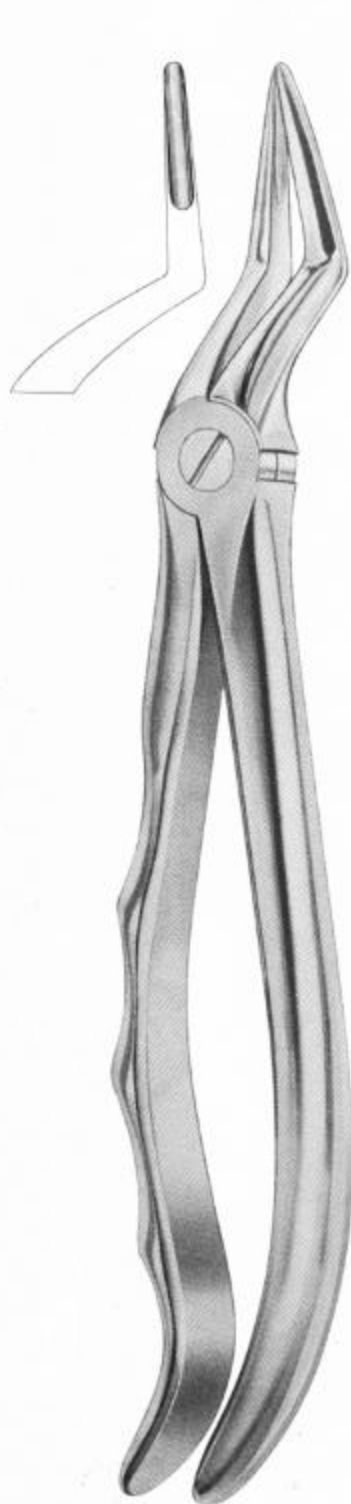

**1180**  
Fig. 51L  
upper roots



**1181**  
Fig. 52  
upper roots



**1182**  
Fig. 54  
for separating  
upper molars

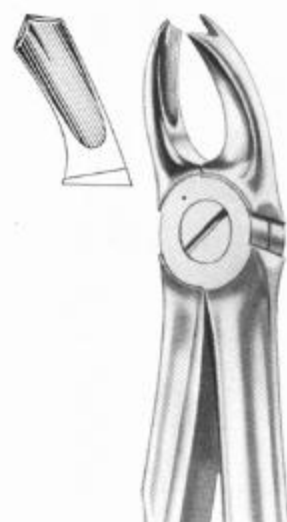

**1183**  
Fig. 65R  
upper molars right

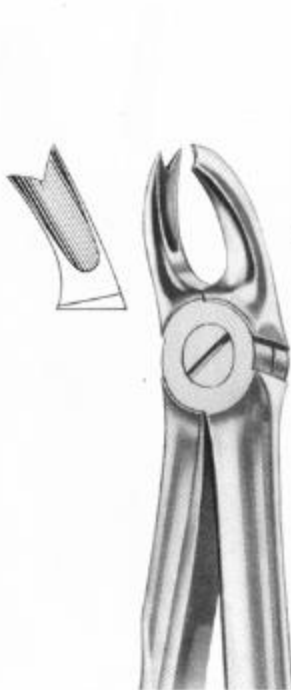

**1184**  
Fig. 65L  
upper molars left

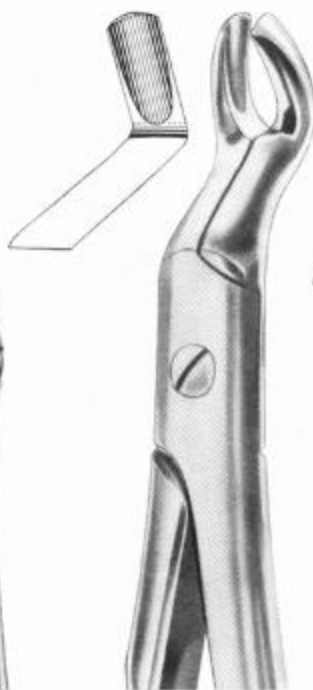

**1185**  
Fig. 67  
upper third molars

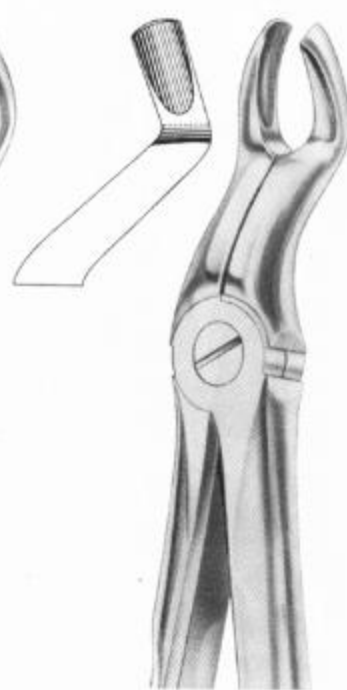

**1186**  
Fig. 67A  
upper third molars

## EXTRACTING FORCEPS

### WITH FITTING HANDLE



**1187**  
Fig. 67 ½ R  
upper third molars  
right

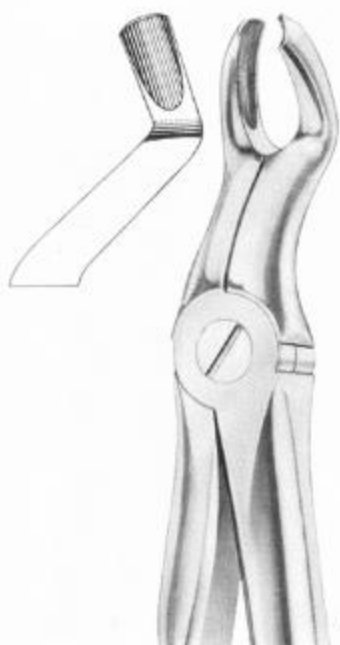

**1188**  
Fig. 67 ½ L  
upper third molars  
left



**1189**  
Fig. 73  
lower molars



**1190**  
Fig. 74  
lower roots



**1191**  
Fig. 74M  
lower roots



**1192**  
Fig. 74N  
lower roots



**1193**  
Fig. 74XN  
lower roots and  
crowded incisors

## EXTRACTING FORCEPS

### WITH FITTING HANDLE



**1194**  
Fig. 75  
lower premolars



**1195**  
Fig. 76  
upper roots



**1196**  
Fig. 76N  
upper roots



**1197**  
Fig. 81  
lower premolars  
and roots

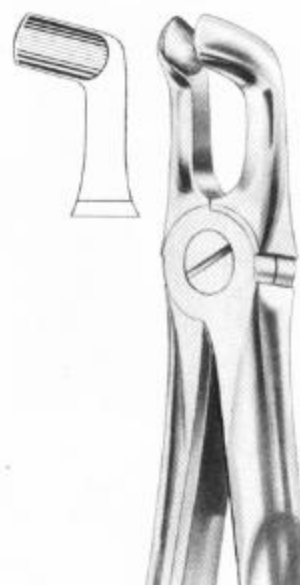

**1198**  
Fig. 76A  
lower third molars

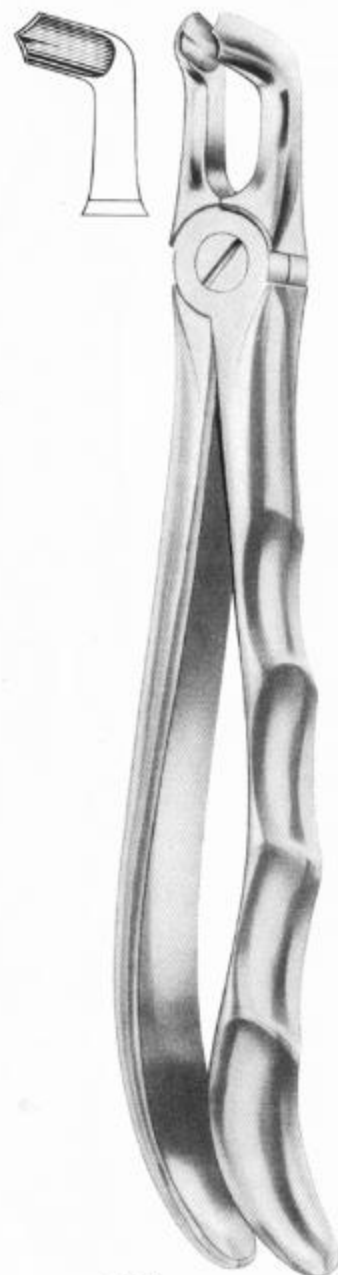

**1199**  
Fig. 79  
lower third molars

## EXTRACTING FORCEPS

### WITH FITTING HANDLE



**1200**  
Fig. 86A  
lower molars



**1201**  
Fig. 86B  
lower molars



**1202**  
Fig. 86C  
lower molars



**1203**  
Fig. 99  
lower molars



**1204**  
Fig. 99 1/4  
lower molars



**1205**  
Fig. 136  
upper premolars  
and roots



**1206**  
Fig. 143  
lower roots

# EXTRACTING FORCEPS

## FOR CHILDREN



**1207**  
KLEIN (Fig. 217)  
upper incisors



**1208**  
KLEIN (Fig. 218)  
upper premolars



**1209**  
KLEIN (Fig. 219)  
upper roots



**1210**  
KLEIN (Fig. 220)  
upper molars



**1211**  
KLEIN (Fig. 221)  
lower incisors



**1212**  
KLEIN (Fig. 222)  
lower molars



**1213**  
KLEIN (Fig. 223)  
lower roots



**1214**  
ALBRECHT  
Fig. 224  
Deciduous



**1215**  
ALBRECHT  
Fig. 225  
Deciduous

**ROOT SPLINTER FORCEPS**

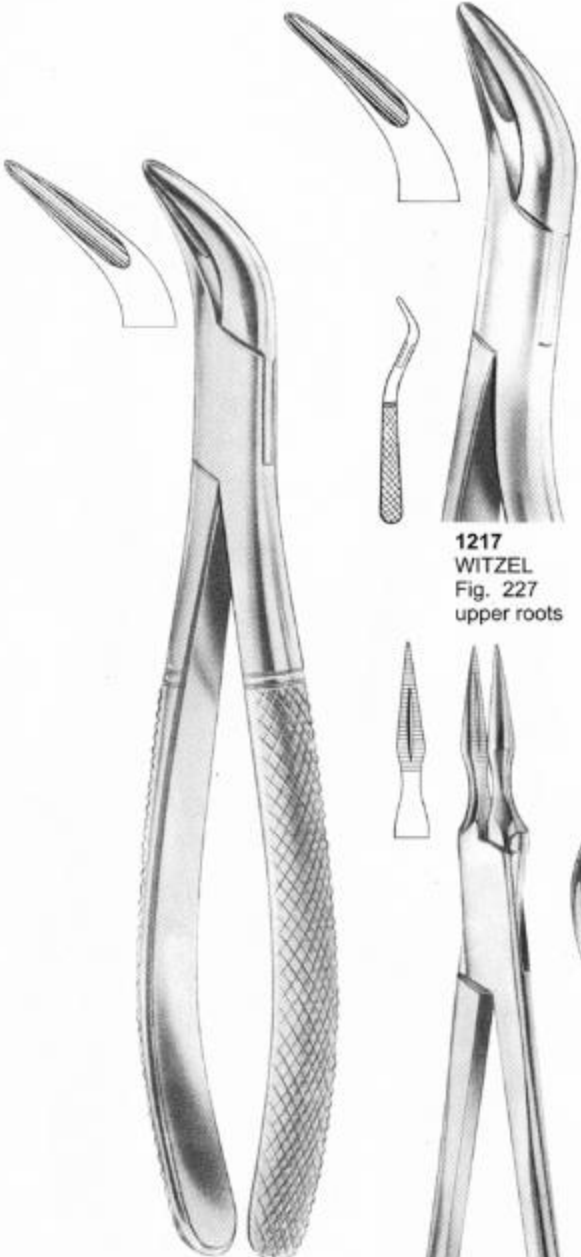

**1216**  
WITZEL  
Fig. 226  
lower roots

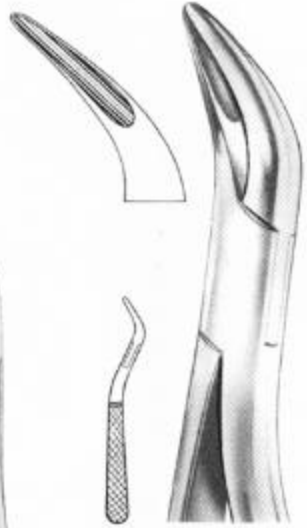

**1217**  
WITZEL  
Fig. 227  
upper roots



**1218**  
ARTHUR  
Fig. 228  
root fragments

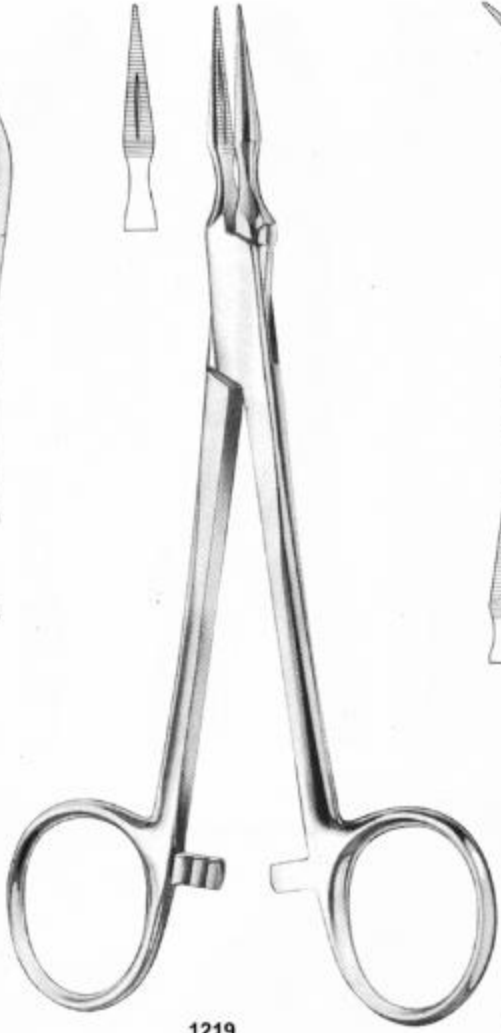

**1219**  
STIEGLITZ  
Fig. 229  
root fragments

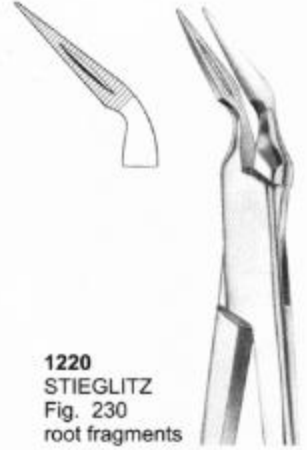

**1220**  
STIEGLITZ  
Fig. 230  
root fragments



**1221**  
RALK  
Fig. 231  
root fragments

# EXTRACTING FORCEPS

## AMERICAN PATTERN



**1222**  
W1-WINTER  
upper centrals  
and canines

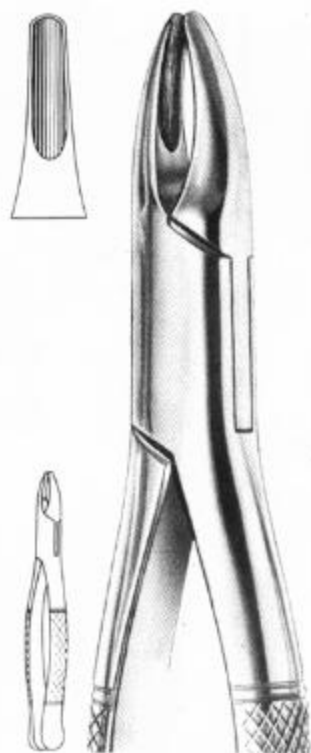

**1223**  
Fig. 1  
upper incisors and roots

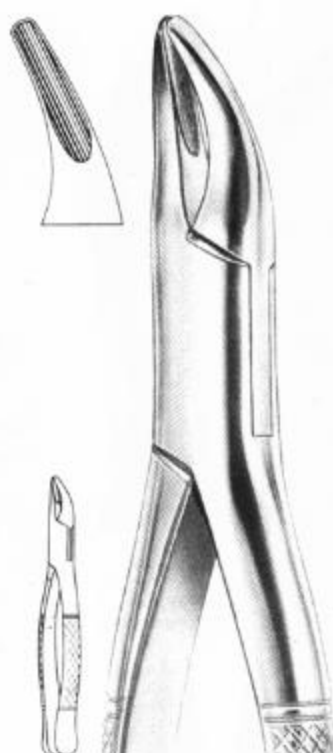

**1224**  
Fig. 2  
upper and lower roots

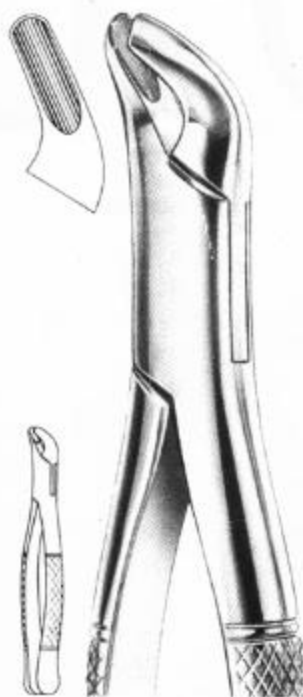

**1225**  
Fig. 4  
upper and lower premolars

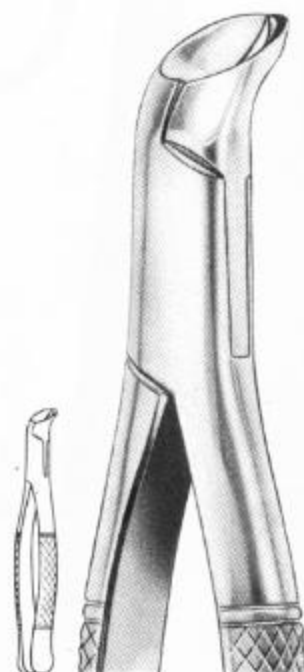

**1226**  
PHYSICK  
Fig. 5  
lower third molars



**1227**  
Fig. 6  
separating  
forceps



# EXTRACTING FORCEPS

## AMERICAN PATTERN



1228  
Fig. 7  
upper roots

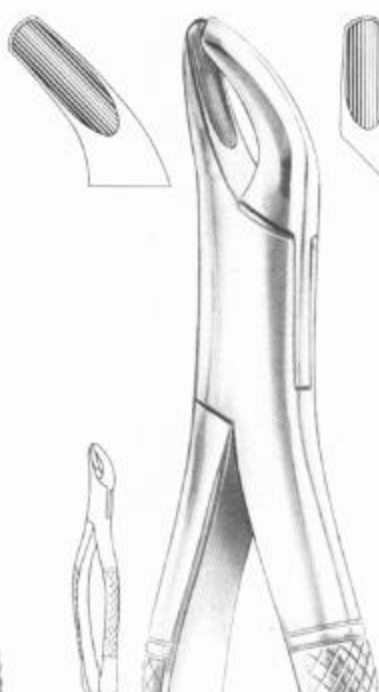

1229  
Fig. 8  
upper and lower  
third molars

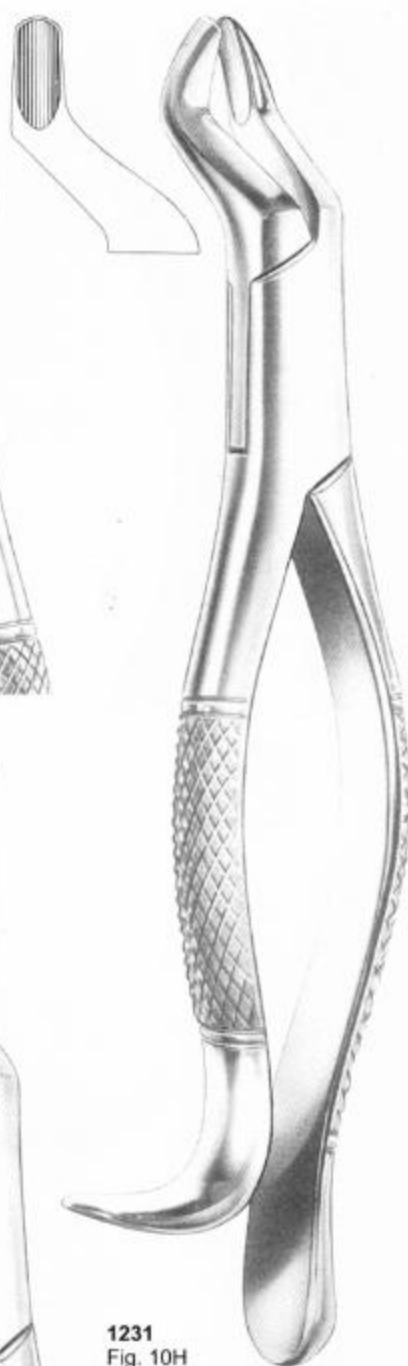

1231  
Fig. 10H  
upper molars

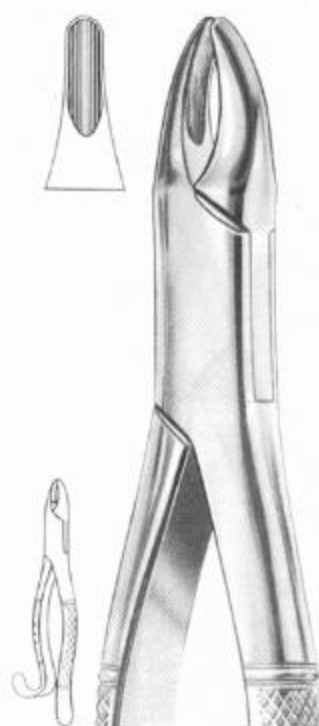

1232  
Fig. 13  
upper incisors

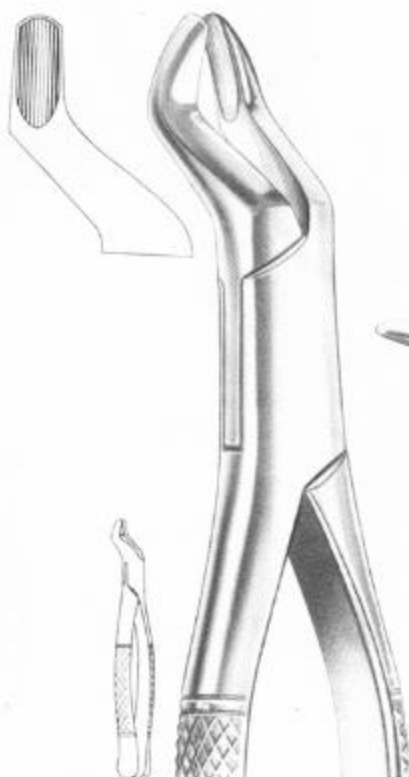

1230  
Fig. 10S  
upper molars



1233  
Fig. 14  
lower incisors

# EXTRACTING FORCEPS

## AMERICAN PATTERN

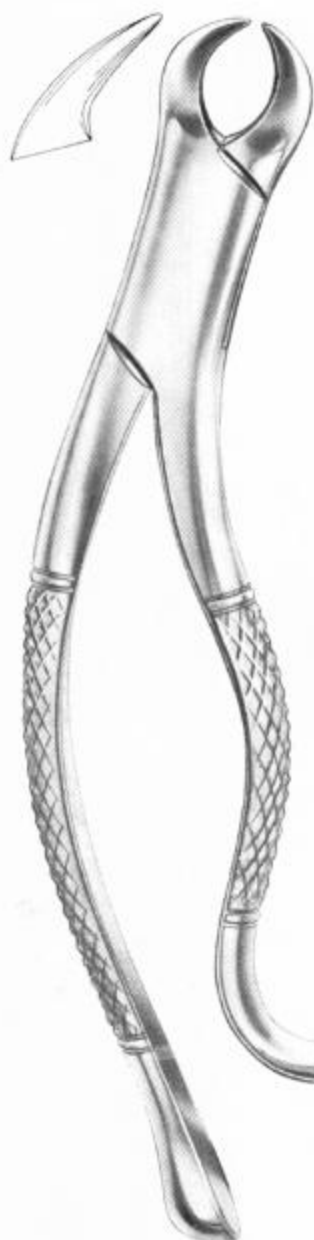

**1234**  
Fig. 16  
lower molars



**1235**  
HARRIS  
Fig. 15  
lower molars

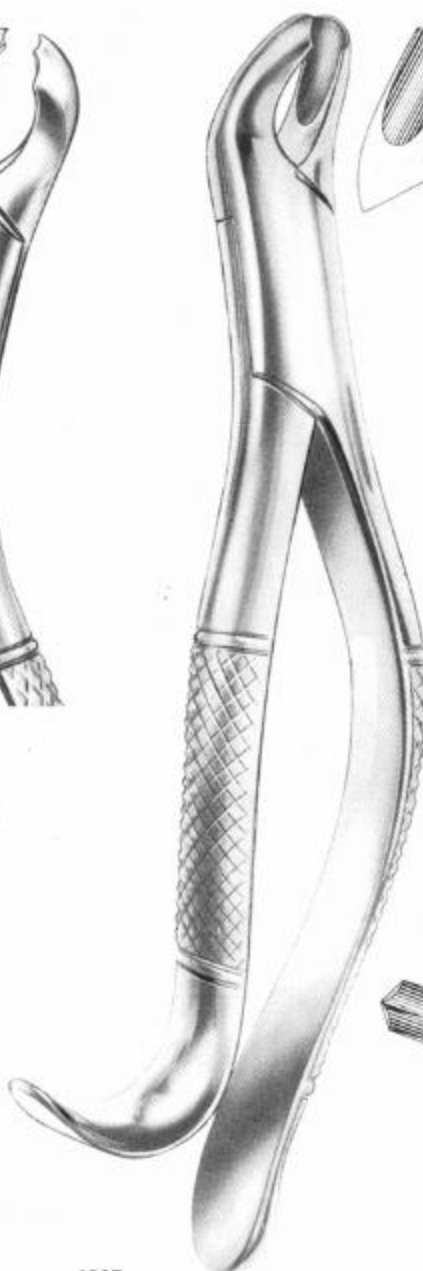

**1237**  
HARRIS  
Fig. 18R  
upper molars right



**1238**  
HARRIS  
Fig. 18L  
upper molars left



**1236**  
Fig. 16S  
lower molars  
for children

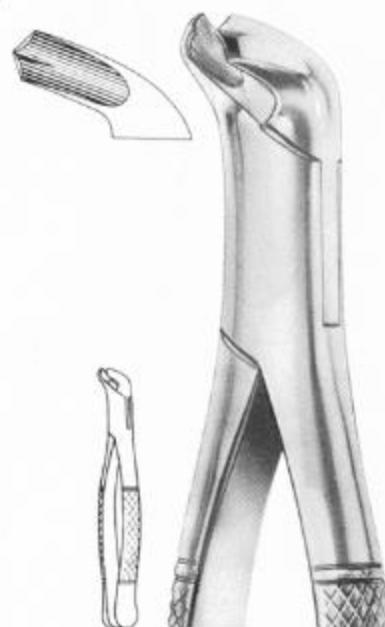

**1239**  
Fig. 17  
lower molars

# EXTRACTING FORCEPS

## AMERICAN PATTERN

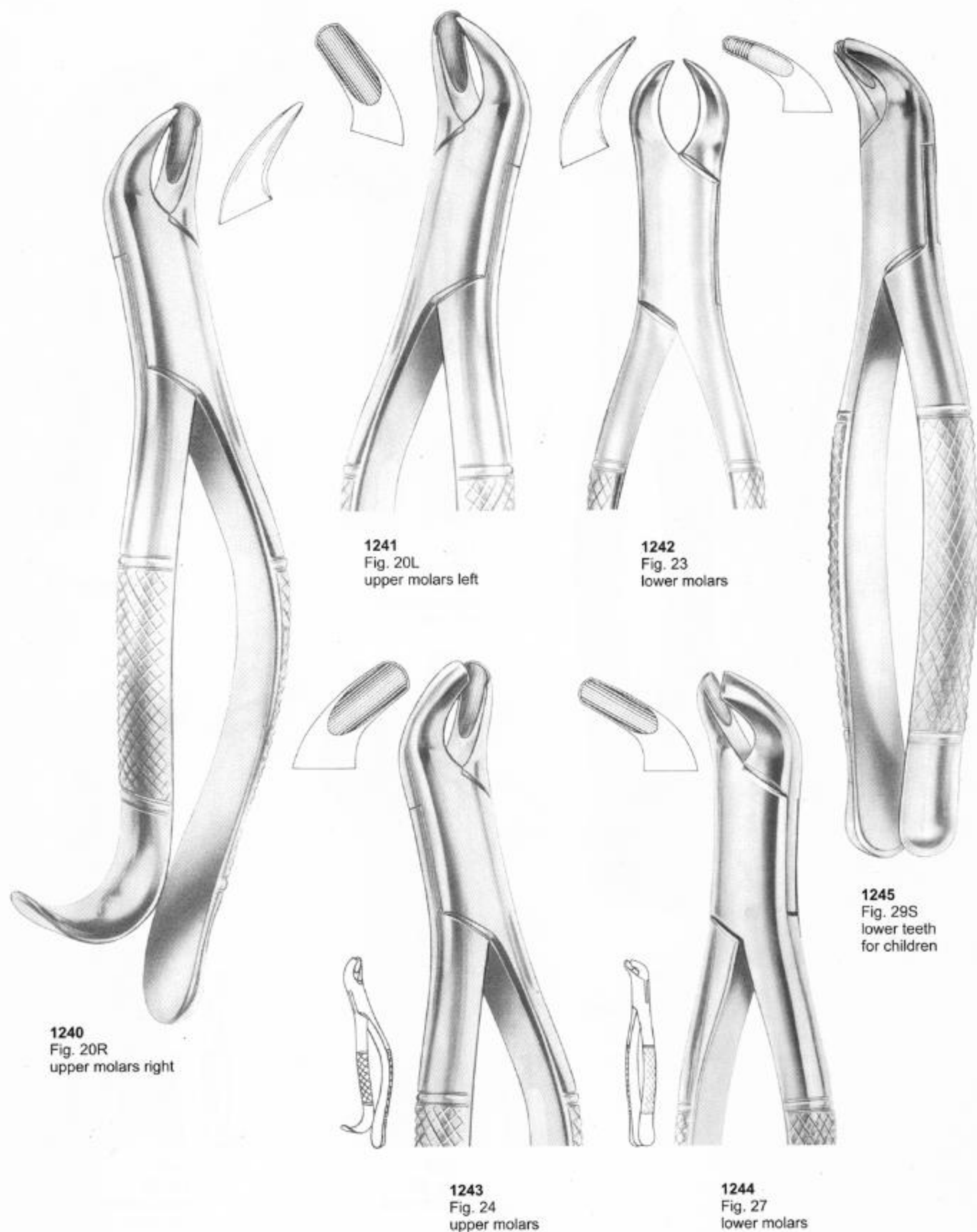

# EXTRACTING FORCEPS

## AMERICAN PATTERN



**1246**  
Fig. 30S  
upper teeth  
for children

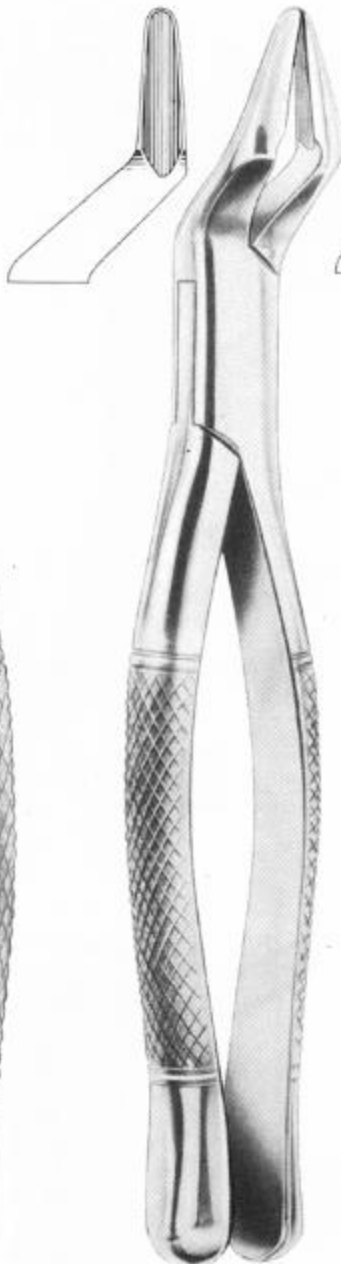

**1247**  
PARMLY  
Fig. 32  
upper premolars  
and molars

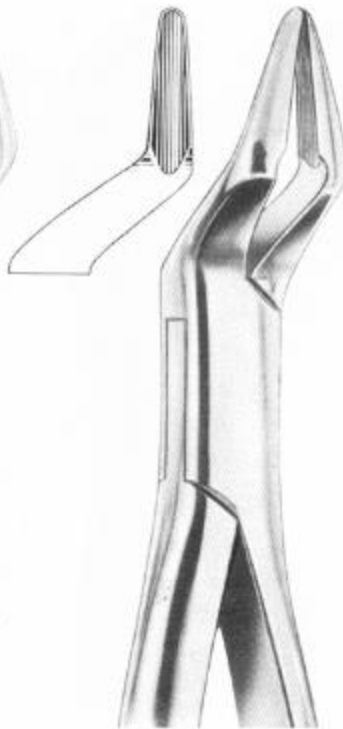

**1248**  
PARMLY  
Fig. 32A  
upper premolars  
and roots

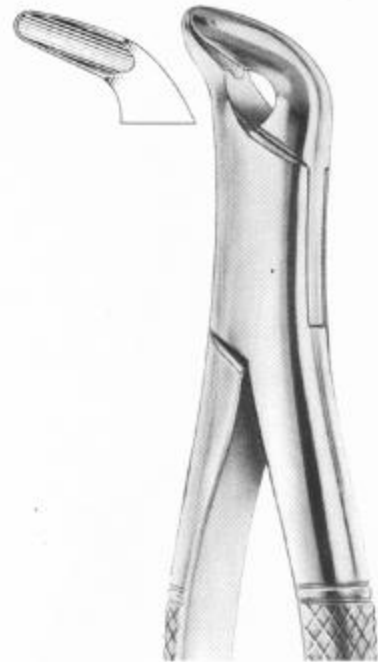

**1249**  
Fig. 34  
lower anteriors  
and roots

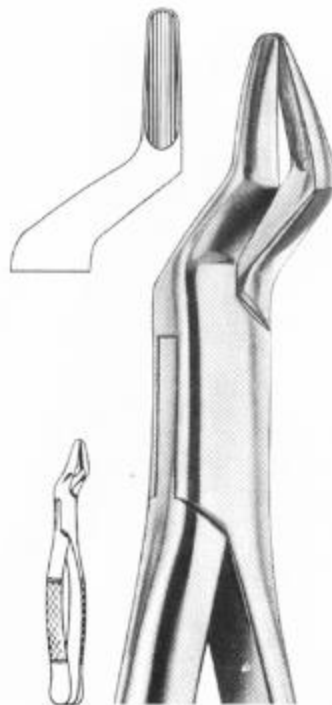

**1250**  
Fig. 35  
upper roots

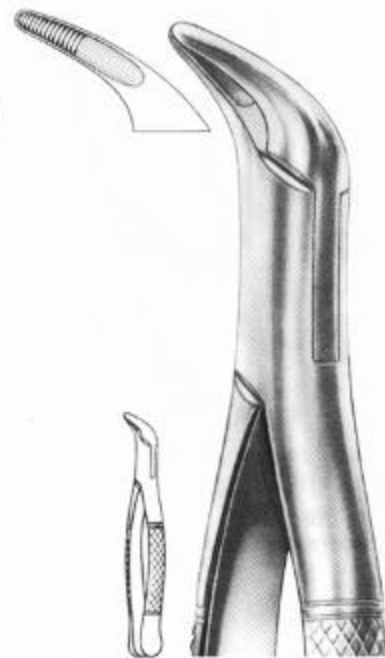

**1251**  
Fig. 36  
lower anteriors  
and roots

# EXTRACTING FORCEPS

## AMERICAN PATTERN



**1252**  
Fig. 37  
lower anteriors  
and roots



**1254**  
Fig. 53R  
upper molars right

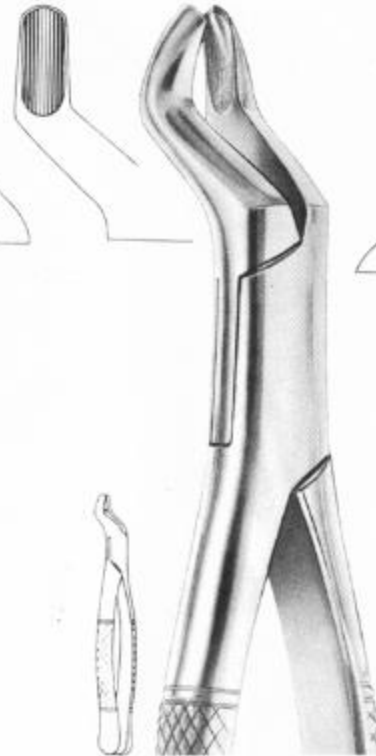

**1255**  
Fig. 53L  
upper molars left

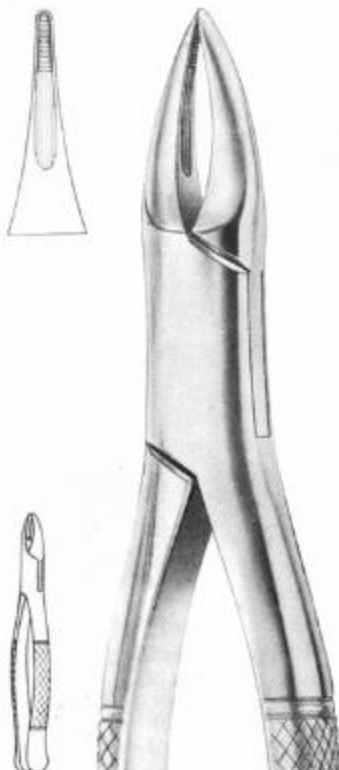

**1253**  
Fig. 38  
upper anteriors  
and roots

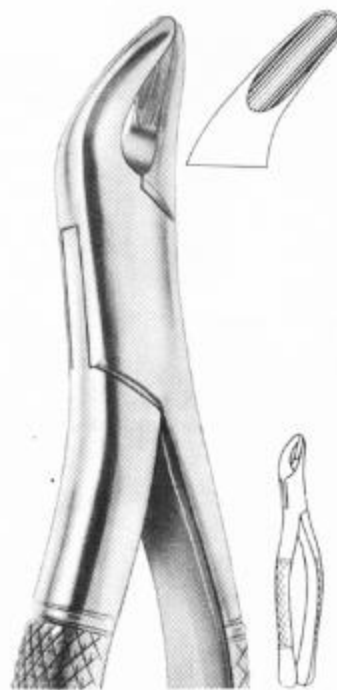

**1256**  
Fig. 62  
incisors, premolars,  
deciduous teeth



**1257**  
Fig. 65  
upper incisors  
and roots

# EXTRACTING FORCEPS

## AMERICAN PATTERN

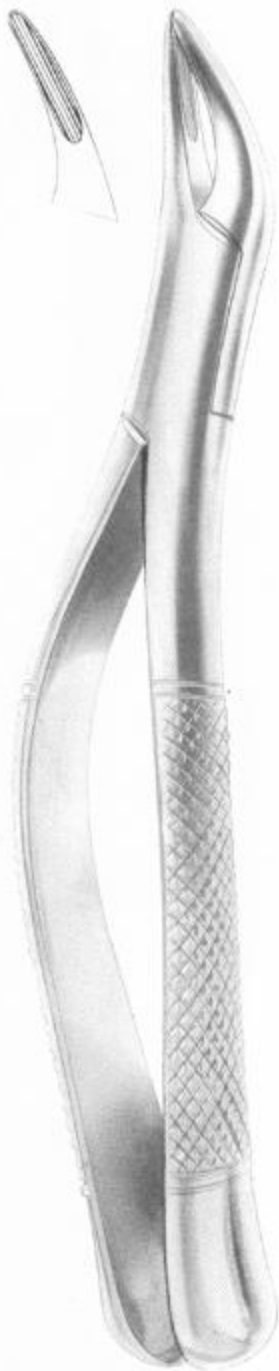

**1258**  
TOMES  
Fig. 69  
upper and lower roots

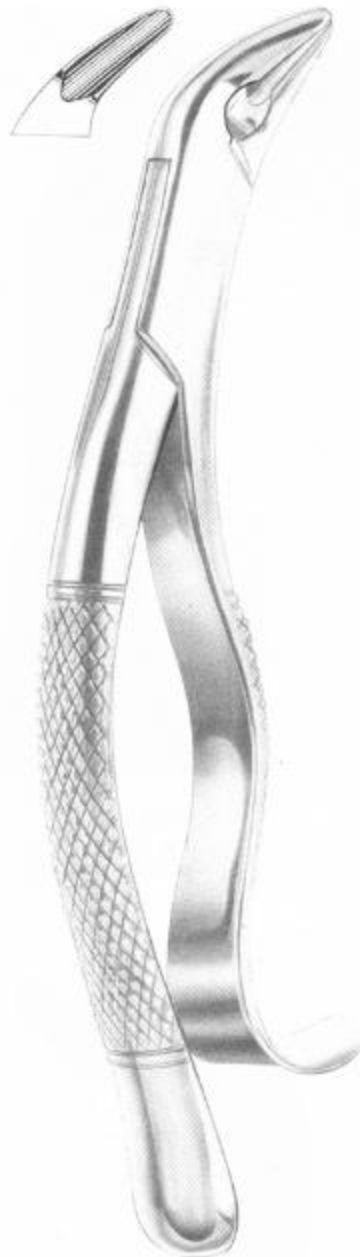

**1259**  
TOMES  
Fig. 85  
lower canines,  
premolars and molars



**1260**  
NEVIUS  
Fig. 88R  
upper molars right

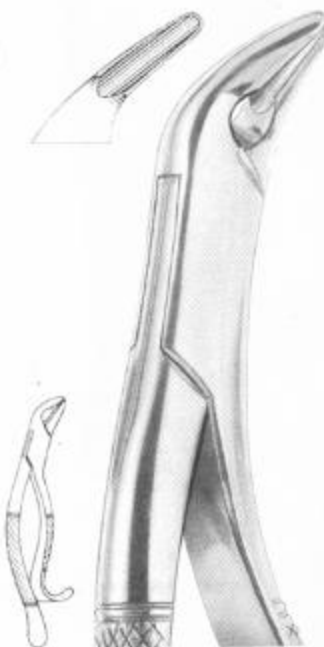

**1261**  
THOMAS  
Fig. 85A  
lower canines,  
premolars and molars



**1262**  
NEVIUS  
Fig. 88L  
upper molars left

# EXTRACTING FORCEPS

## AMERICAN PATTERN



**1263**  
KELLS  
Fig. 99A  
upper incisors,  
canines, premolars

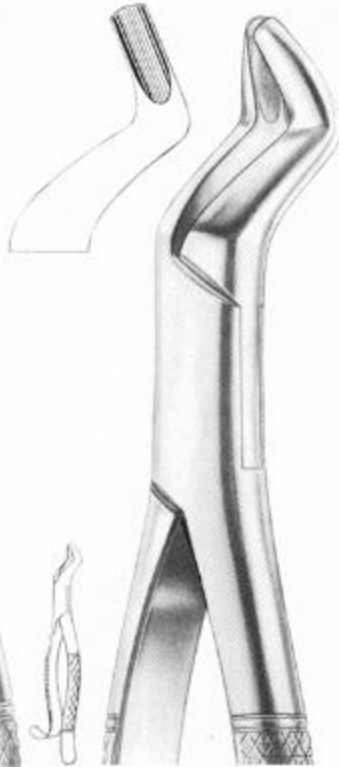

**1264**  
Fig. 104  
upper third molars



**1266**  
HULL  
Fig. 101  
deciduous teeth



**1267**  
Fig. 103  
lower incisors,  
premolars

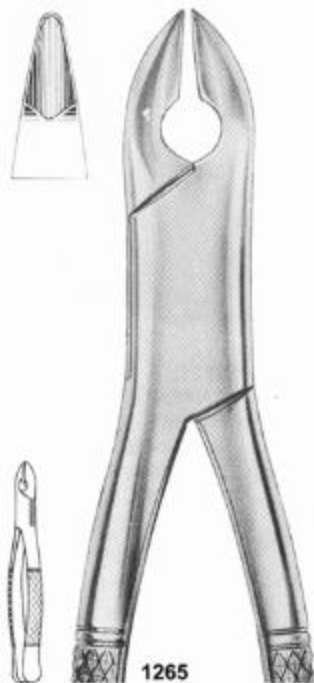

**1265**  
KELLS  
Fig. 99C  
upper incisors,  
canines, premolars

# EXTRACTING FORCEPS

## AMERICAN PATTERN



**1268**  
CRYER  
Fig. 150  
lower incisors,  
premolars, roots

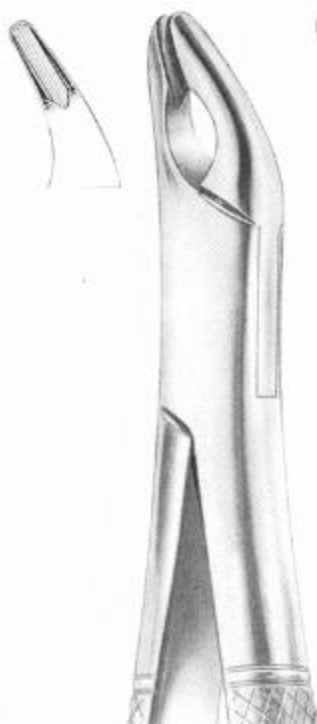

**1269**  
CRYER  
Fig. 150A  
upper incisors,  
premolars, roots

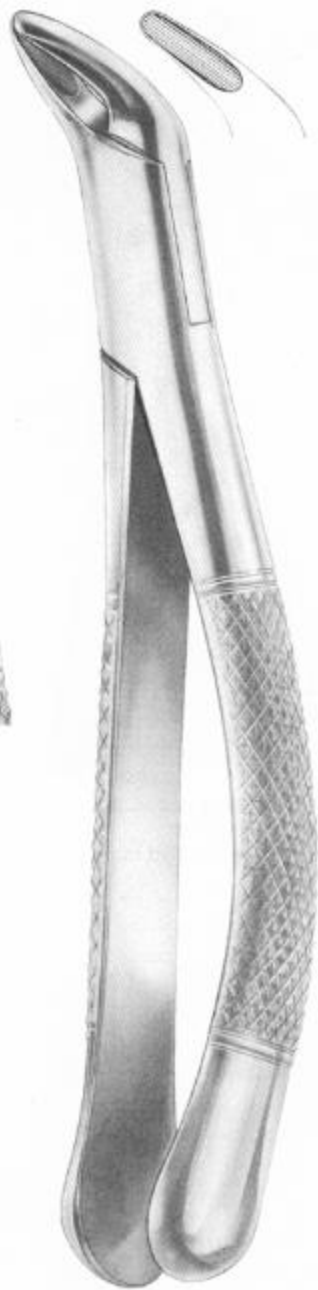

**1271**  
CRYER  
Fig. 151  
lower incisors,  
premolars, roots

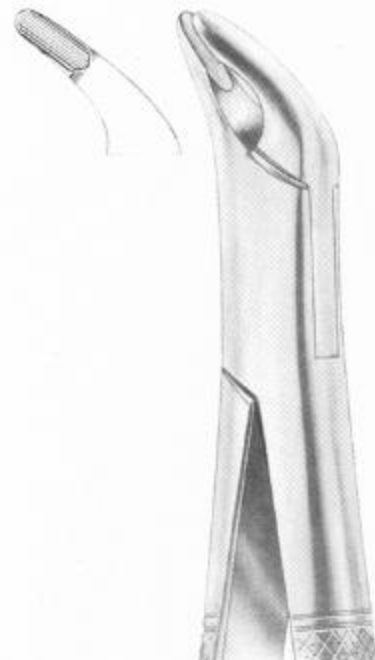

**1272**  
CRYER  
Fig. 151A  
lower incisors,  
premolars, roots

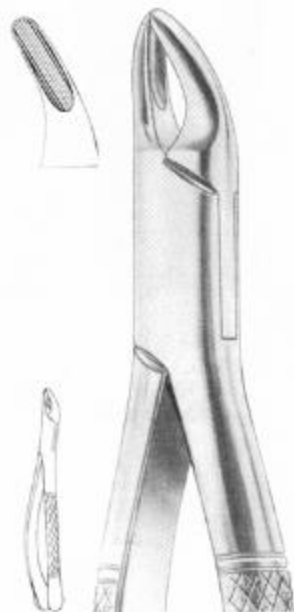

**1270**  
CRYER  
Fig. 150S  
upper teeth for children

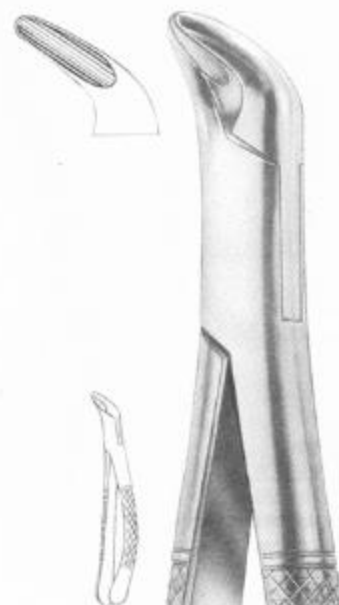

**1273**  
CRYER  
Fig. 151S  
lower teeth  
for children



# EXTRACTING FORCEPS

## AMERICAN PATTERN



**1274**  
Fig. 203  
lower incisors  
and roots

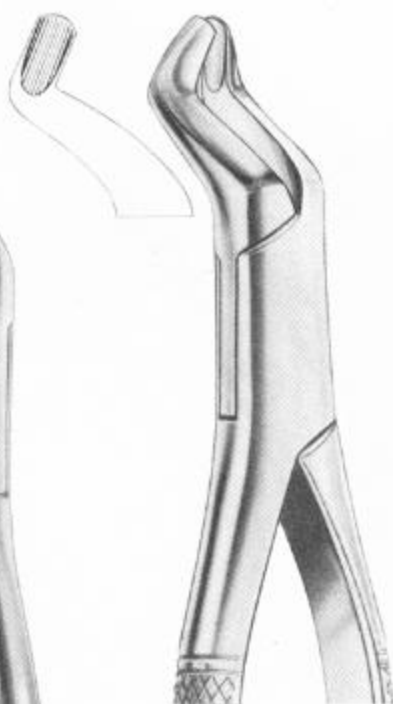

**1275**  
Fig. 210S  
upper third molars

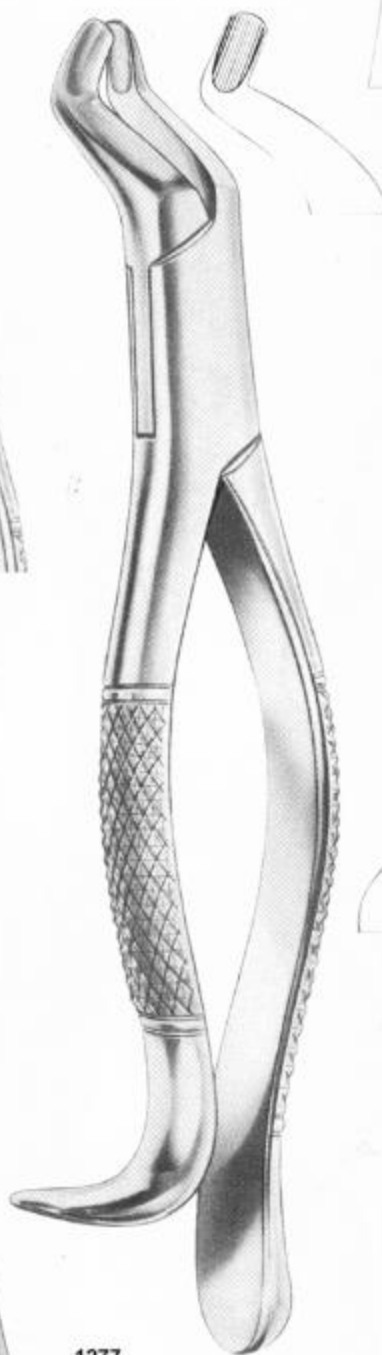

**1277**  
Fig. 210H  
upper third molars

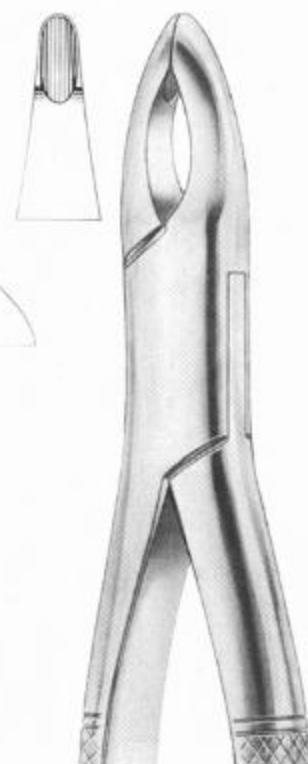

**1278**  
Fig. 213  
upper centrals and canines

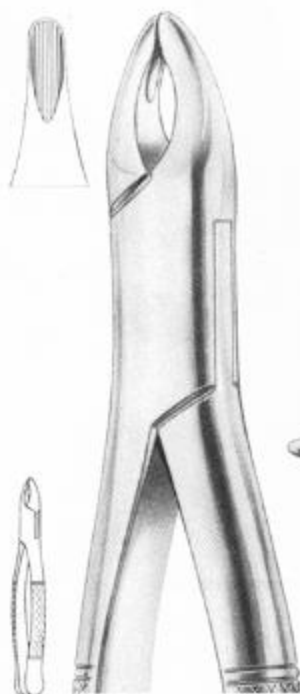

**1276**  
Fig. 201  
upper incisors,  
canines, premolars

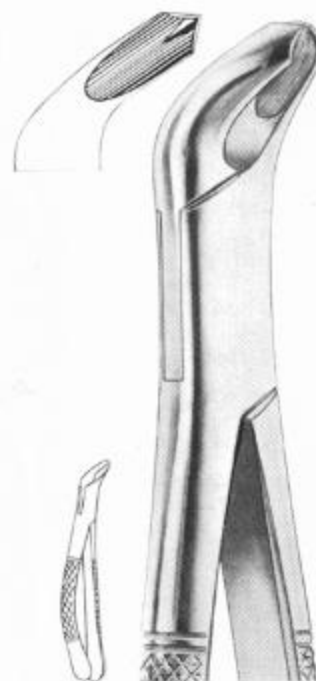

**1279**  
Fig. 217  
lower molars

# EXTRACTING FORCEPS

## AMERICAN PATTERN

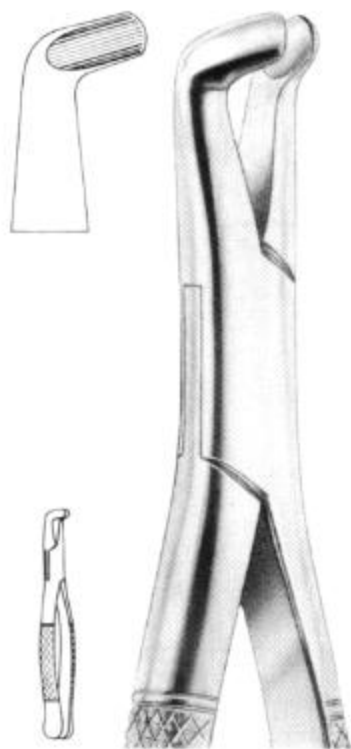

**1280**  
Fig. 222  
lower third molars

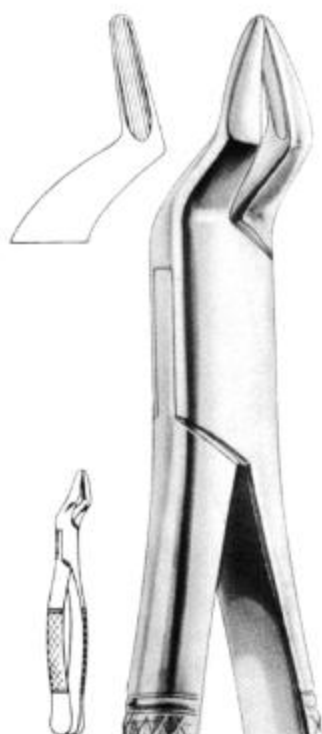

**1281**  
Fig. 286  
upper incisors and roots



**1282**  
Fig. 286  
Swing lower molars



**1283**  
Fig. 288  
lower canines  
and premolars

# EXTRACTING FORCEPS

## AMERICAN PATTERN



**1284**  
COHEN  
Fig. 310  
universal forceps

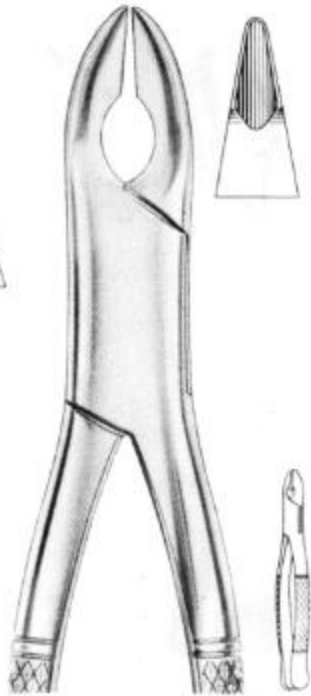

**1285**  
NEVIUS  
Fig. 320/10S  
upper canines

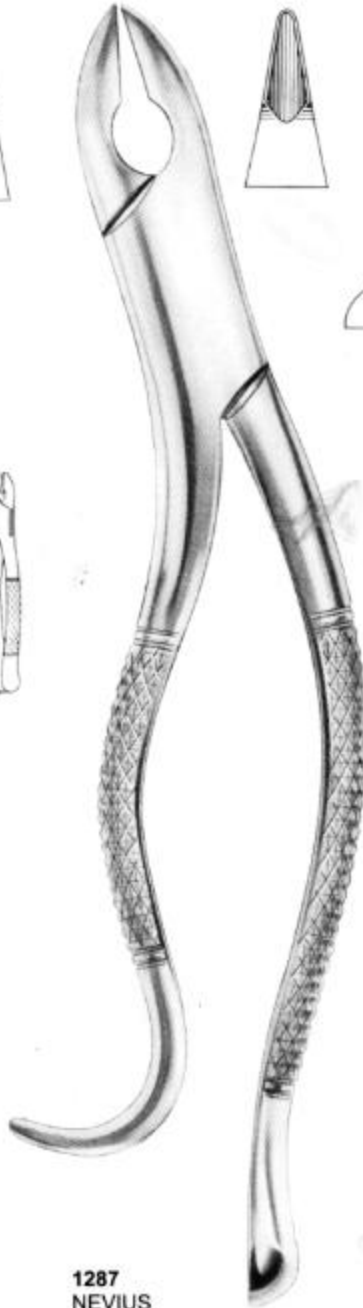

**1287**  
NEVIUS  
Fig. 325/10H  
upper canines

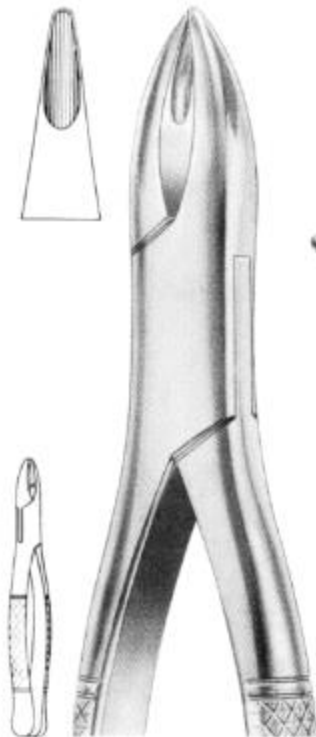

**1286**  
HENAHAN  
Fig. 315/1A  
upper incisors



**1288**  
STANDARD  
Fig. 330/4  
upper third molars

# EXTRACTING FORCEPS

## AMERICAN PATTERN



**1289**  
WOODWARD  
Fig. 335/FH  
lower molars



**1290**  
Fig. 340/89  
upper molars right

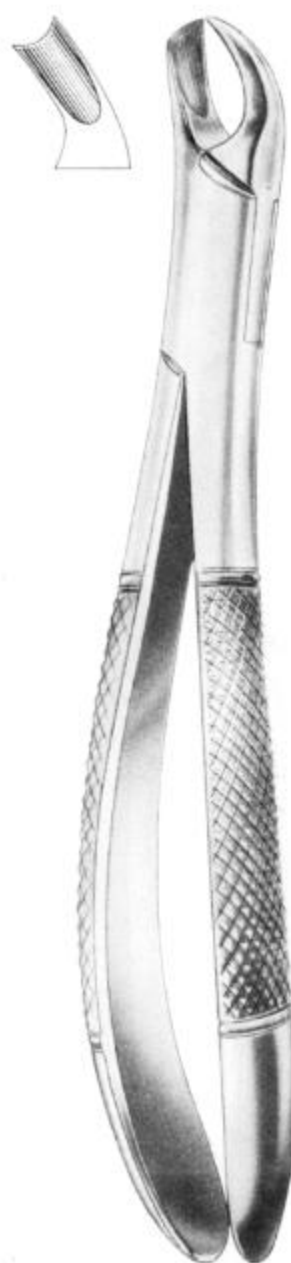

**1292**  
Fig. 345/90  
upper molars left

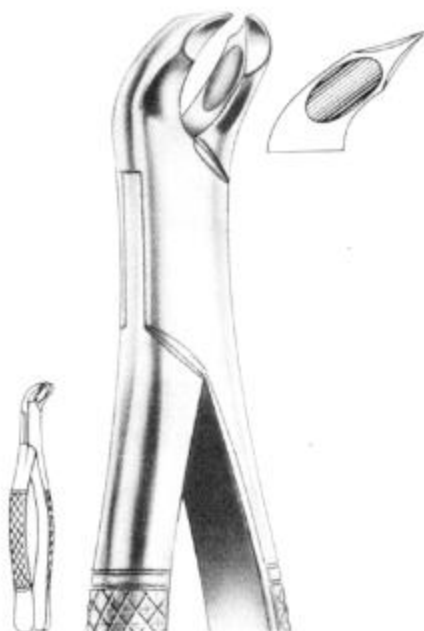

**1291**  
WOODWARD  
Fig. 335/FS  
lower molars

# EXTRACTING FORCEPS

## AMERICAN PATTERN



**1293**  
Fig. 350/23S  
lower molars

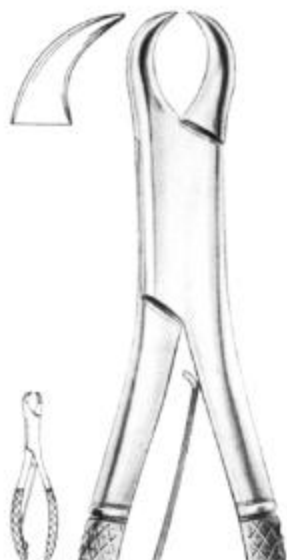

**1294**  
Fig. 355/23SK  
lower molars



**1295**  
Forcep Fig. 301



**1295-A**  
Forcep Fig. 300



**1296**  
Fig. 360/17SK  
lower molars



**1297**  
Fig. 365/150SK  
upper anteriors  
and roots



**1298**  
Fig. 370/151SK  
lower anteriors  
and roots

## Physics Forceps: Standard Series Set (Dental Extraction Forceps)

CSC 1301R - Upper Right, teeth no. 2 to 5

CSC 1301L - Upper Left, teeth no. 12 to 15

CSC 1302A - Upper Anterior, teeth no. 6 to 11

CSC 1303U - Universal Lower, teeth no. 18 to 31

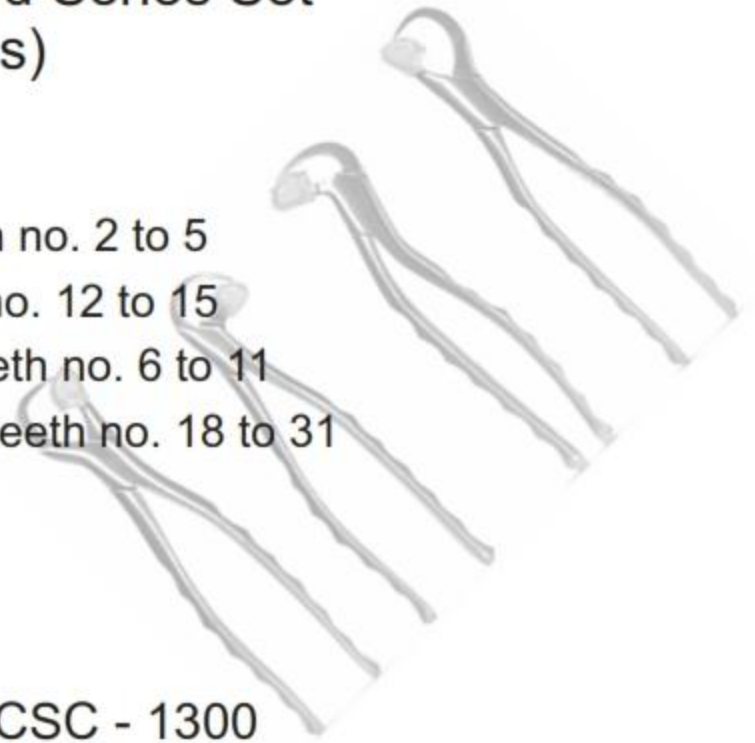

Complete Set Art Number: CSC - 1300  
with leather pouch packing.



Upper Left   Lower Universal   Upper Anterior   Upper Right

## EXTRACTING FORCEPS

Extracting forceps set of 10 pcs.



Extracting forceps set of 12 pc  
No. 17, 7, 13, 17, 18, 51a, 67,  
73, 74n, 86, 89 & 90



Extracting forceps set of 6 pcs.  
No. 51a. 18, 17, 13, 7, 1.



Extracting forceps set of 6 pcs.  
No. 90, 89, 86, 74n, 73 & 67



## PERISTEEL ELEVATORS



**1299**  
Molt 9



**1300**  
Allen 9A



**1301**  
Prichard



**1302**  
Seldin



**1303**  
Goldman- Fox 14



**1304**  
West  
Dell W2



# ELEVATORS

## Heidbrink Root - Tip Picks

Root Tip



1305  
DEL 78



1306  
DEL 79



1307  
DEL 80



1308  
DEL H1



1309  
DEL H2



1310  
DEL H3

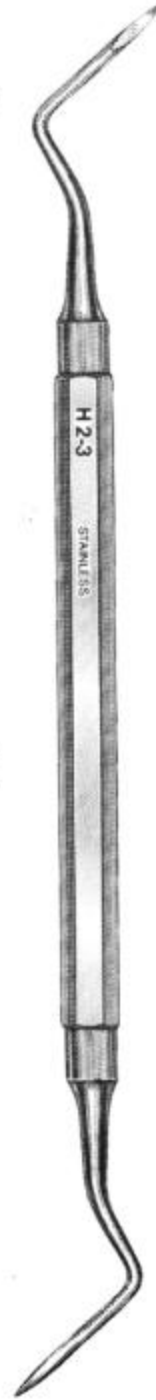

1311  
DEL H2-3

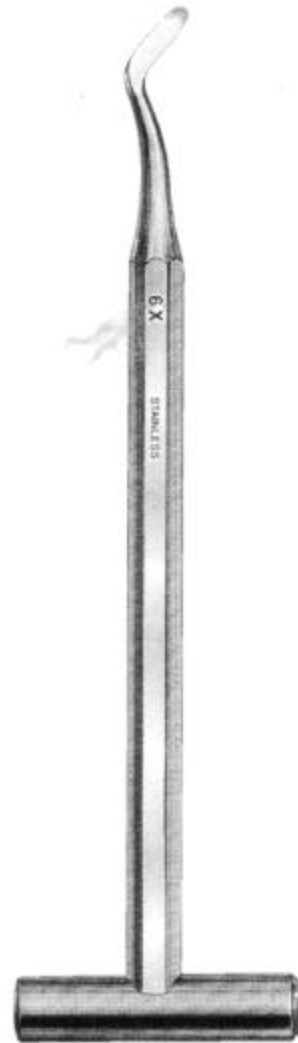

1312  
POTT  
6X

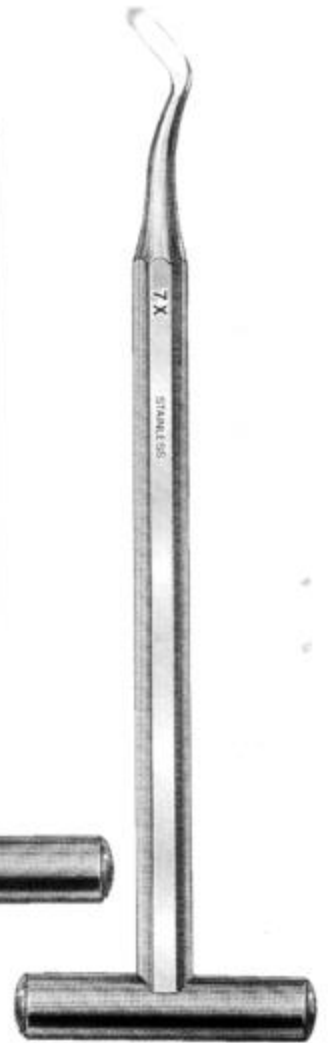

1313  
POTT  
7X

## PERIOSTEAL ELEVATORS



**1314**  
BUSER



**1315**  
OHI 10



**1316**  
HOWARD 9H



**1317**  
FREER



**1318**  
FREER 15



**1319**  
FREER 16

# SELECT HANDLE

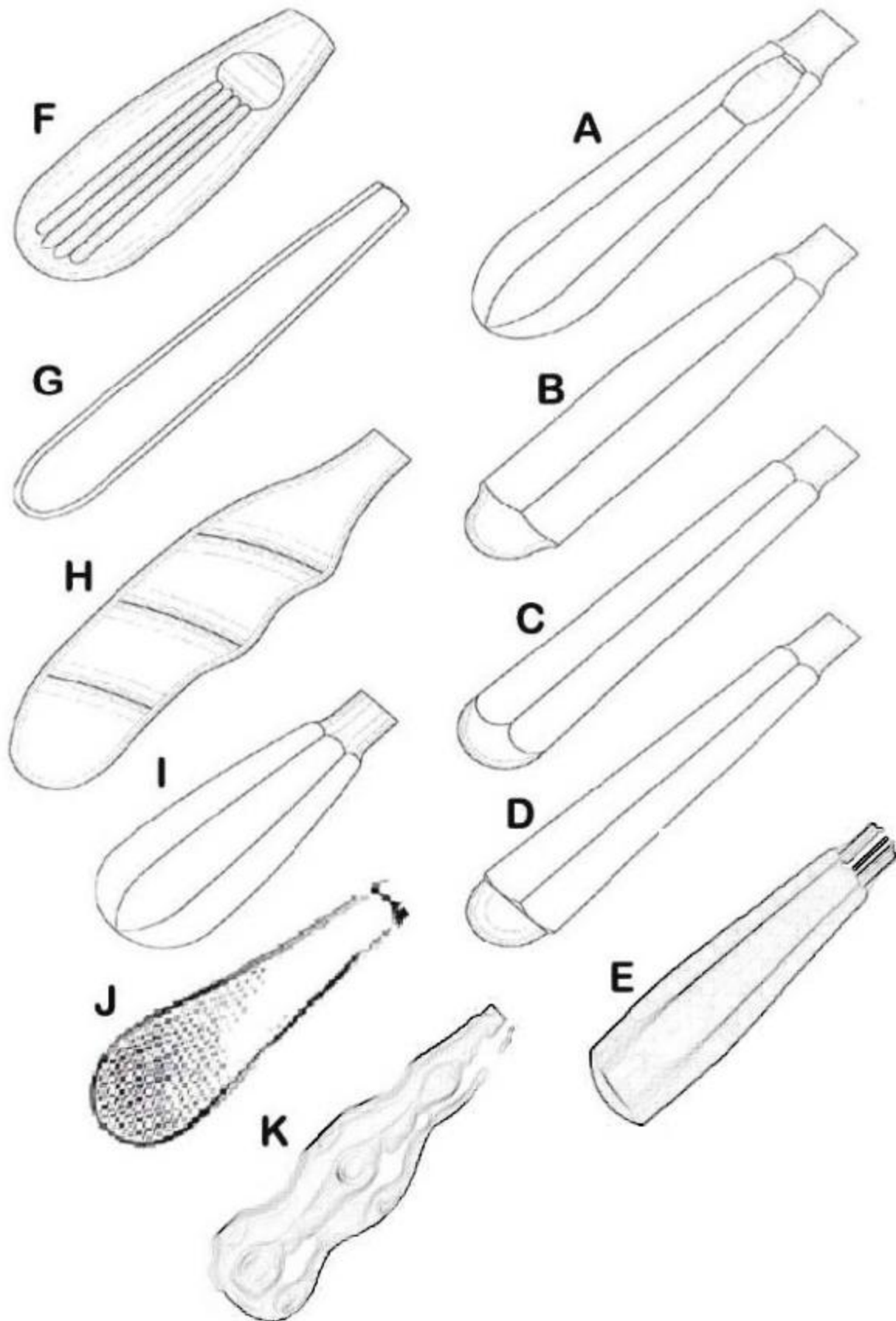

# ROOT ELEVATOR



**1320**  
Fig. 1B Bein



**1320-1**  
Fig. 28  
Bein



**1320-2**  
Fig. 38  
Bein



**1320-3**  
Fig. 48  
Bein



**1320-4**  
Fig. 58  
Bein



**1320-5**  
Fig. 68  
Bein



**1320-6**    **1320-7**  
Fig. 4SA    Fig. 5SA  
Schmeckebeer-Apexo



**1320-8**  
Fig. 34S  
Seldin



**1320-9**  
Fig. 34  
Seldin



**1320-10**  
Fig. 2S  
Seldin



**1320-11**  
Fig. 3S  
Seldin



**1320-12**  
Fig. 1F  
Flohr



**1320-13**  
Fig. 2F  
Flohr



**1320-14**  
Fig. 3F  
Flohr

# ROOT ELEVATOR



**1321-1**  
Fig. 72  
Miller-Apexo

**1321-2**  
Fig. 73  
Miller-Apexo

**1321-3**  
Fig. 74  
Miller-Apexo

**1321-4**  
Fig. 19

**1321-5**  
Fig. 20

**1321-6**  
Fig. 51  
Curtis

**1321-7**  
Fig. 52  
Curtis

**1321**  
Fig. 71  
Miller-Apexo

**1321-8**  
Fig. 1L  
Seldin

**1321-9**  
Fig. 1R  
Seldin

**1321-10**  
Fig. 4L  
Seldin

**1321-11**  
Fig. 4R  
Seldin

**1321-12**  
Fig. 11  
Stout

**1321-13**  
Fig. 11A  
Stout

**1321-14**  
Fig. 44C  
Stout

# ROOT ELEVATOR



**1322**  
Fig. A  
Cogswell



**1322-1**  
Fig. B  
Cogswell



**1322-2**  
Fig. 301  
Apexo



**1322-3**  
Fig. 302  
Apexo



**1322-4**  
Fig. 303  
Apexo



**1322-5**  
Fig. 301  
Seldin



**1322-6**  
Fig. 304W  
Seldin



**1322-7**  
Fig. 1H  
Heidbrink



**1322-8**  
Fig. 2H  
Heidbrink



**1322-9**  
Fig. 40H  
Heidbrink



**1322-10**  
Fig. 41H  
Heidbrink



**1322-11**  
Fig. 46



**1322-12**  
Fig. 46R

# ROOT ELEVATOR



# ROOT ELEVATOR

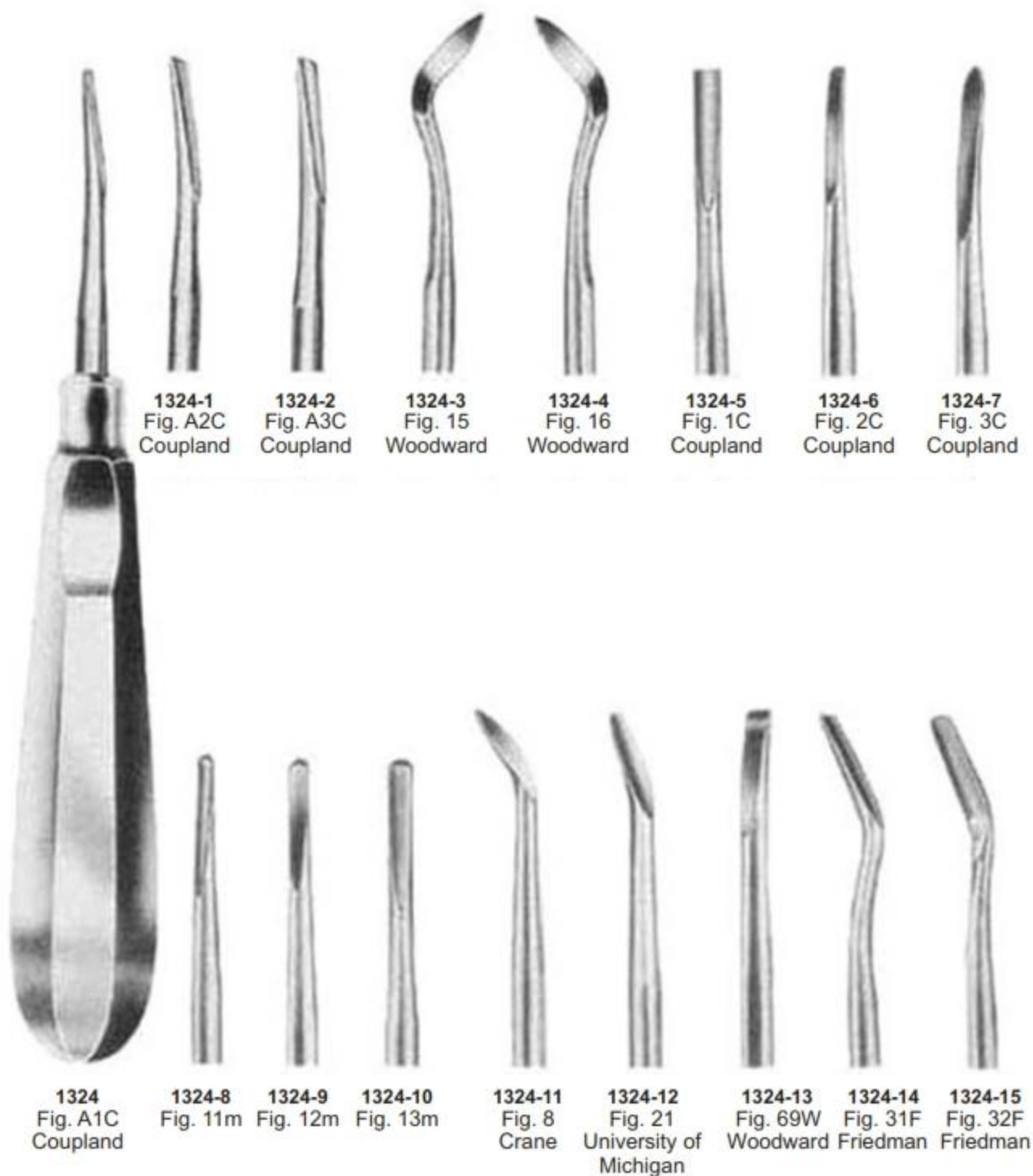



# ROOT ELEVATOR



1325  
Fig. 1  
Bein



1325-1  
Fig. 2  
Bein



1325-2  
Fig. 3  
Bein



1325-3  
Fig. 4  
Bein



1325-4  
Fig. 5  
Bein



1325-5  
Fig. 6  
Bein



1325-6  
Fig. 1



1325-7  
Fig. 2



1325-8  
Fig. 2  
Flohr



1325-9  
Fig. 3  
Flohr



1325-10  
Fig. 3  
Cryer



1325-11  
Fig. 8  
Cryer

# ROOT ELEVATOR



BD-1326-001



BD-1326-002



1327-1 320 1327-2 321



1327-3 322 1327-4 323



1327-5 370 1327-6 371

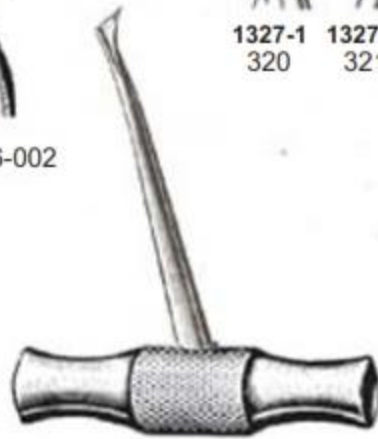

1327  
Walter F. Barry



1328-1  
Fig. 1L



1328-2  
Fig. 1R



1328-3  
Fig. 11L



1328-4  
Fig. 11R



1328-5  
Fig. 11L



1328-6  
Fig. 11R



1328-7  
Fig. 11L



1328-8  
Fig. 11R



1328-9  
Fig. 11L



1328-10  
Fig. 11R



1328  
Winter

# ROOT ELEVATOR

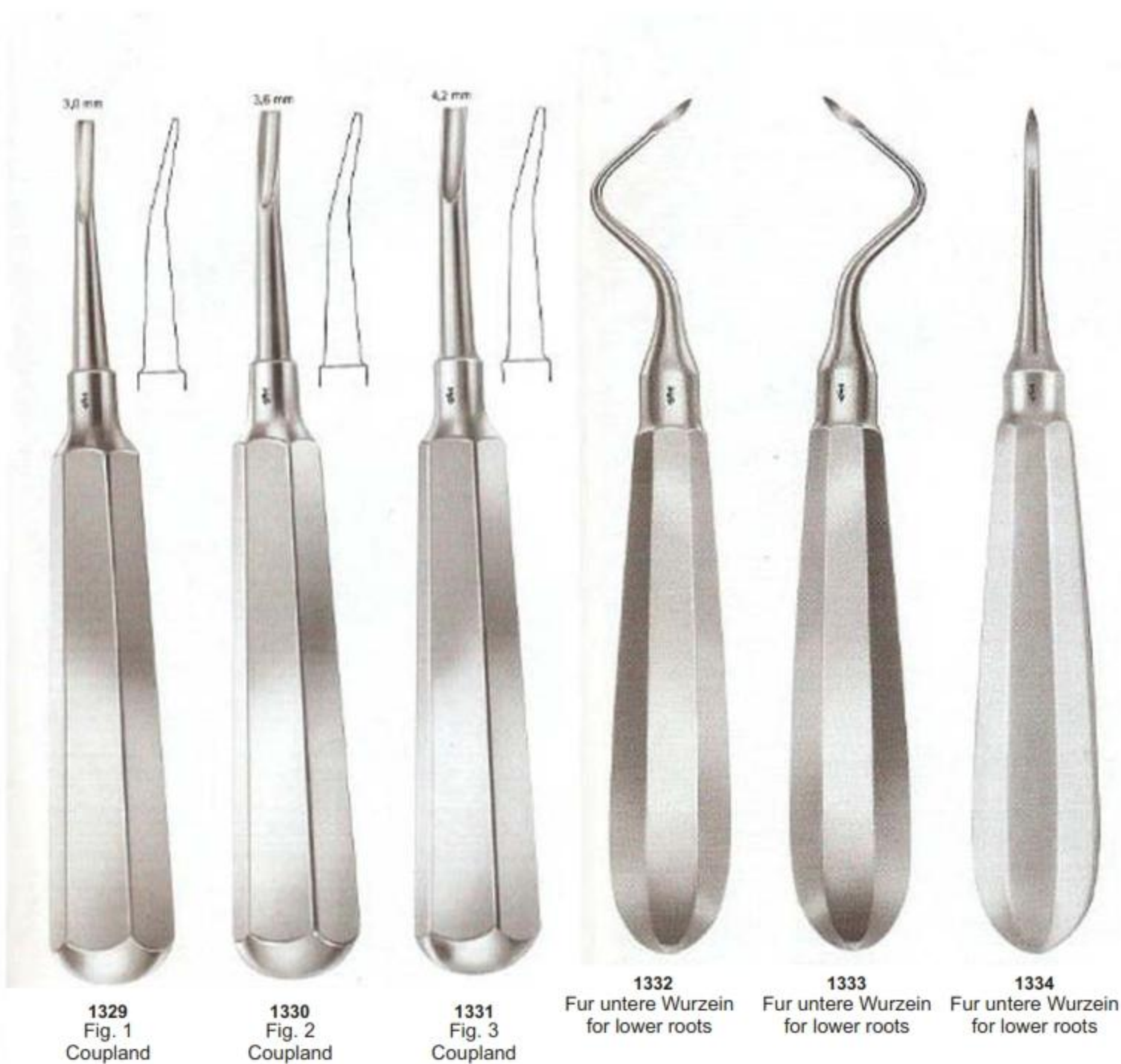

## ROOT ELEVATOR



# ROOT ELEVATOR



**1338**  
Flohr  
für obere wurzein,  
loeffelformig  
for upper roots,  
spoon-shaped



**1339**  
Flohr  
für obere wurzein,  
spitz  
for upper roots,  
Pointed



**1342**  
Hylin 3MM



**1343**  
Hylin 3MM



**1340**  
Flohr  
für untere wurzein  
for lower roots



**1341**  
Flohr  
für untere wurzein  
for lower roots



**1344**  
Hylin 3MM



**1345**  
Hylin 4.5MM

# ROOT ELEVATOR



**1346-1**  
Fig. 6S  
150 mm, 6"



**1346-2**  
Fig. 5S  
150 mm, 6"



**1346-3**  
Fig. 4S  
150 mm, 6"



**1346-4**  
Fig. 3S  
150 mm, 6"



**1346-5**  
Fig. 2S  
150 mm, 6"



**1346-6**  
Fig. 1S  
150 mm, 6"



**1346-7**  
Fig. 0S  
150 mm, 6"

# ROOT ELEVATOR



**1347-1**  
Fig. 6C  
150 mm, 6"



**1347-2**  
Fig. 5C  
150 mm, 6"



**1347-3**  
Fig. 4C  
150 mm, 6"



**1347-4**  
Fig. 3C  
150 mm, 6"



**1347-5**  
Fig. 2C  
150 mm, 6"



**1347-6**  
Fig. 1C  
150 mm, 6"



**1347-7**  
Fig. 0C  
150 mm, 6"

# ROOT ELEVATOR



**1348**  
Fig. 1  
Heidbrink

**1349**  
Fig. 2  
Heidbrink

**1350**  
Fig. 3  
Heidbrink



**1351**  
Fig. 1  
Heidbrink



**1352**  
Fig. 2  
Heidbrink



**1353**  
Fig. 3  
Heidbrink



# ROOT ELEVATOR



1354  
Fig. 1  
Chompret



1354-2  
Fig. 2  
Chompret



1354-3  
Fig. 3  
Chompret



1354-4  
Fig. 4  
Chompret



1354-1  
Fig. 1



1355  
Fig. 2



1356  
Fig. 1



1357  
Fig. 2

# ROOT ELEVATOR



**1358-1**  
Bein  
fur obere wurzein,  
vorne rund  
for upper roots,  
round point



**1358-2**  
Bein  
fur obere wurzein,  
vorne rund  
for upper roots,  
round point



**1358-3**  
Bein  
fur obere wurzein,  
vorne rund  
for upper roots,  
round point



**1358-4**  
Bein  
fur obere wurzein,  
vorne gerade  
for upper roots,  
square point



**1358-5**  
White  
fur obere wurzein,  
gerade  
for upper roots, straight



**1358-6**  
White  
fur obere wurzein,  
gerade  
for upper roots, curved

# ROOT ELEVATOR



1359



1360



1361  
Bein



1362  
Bein  
Fig. 1



1363  
Bein  
Fig. 2

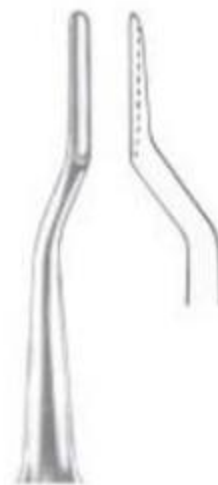

1364  
Bein  
Fig. 3



1365  
Bein  
Fig. 4

# ROOT ELEVATOR



**1366**  
KOPP



**1366-1**  
Fig. 1  
KOPP



**1366-2**  
Fig. 2  
KOPP



**1366-7**  
Fig. 1  
KOPP



**1366-8**  
Fig. 2  
KOPP



**1366-3**  
Fig. 3  
KOPP



**1366-4**  
Fig. 4  
KOPP



**1366-9**  
Fig. 3  
KOPP



**1366-10**  
Fig. 4  
KOPP



**1366-5**  
Fig. 5  
KOPP



**1366-6**  
Fig. 6  
KOPP

# ROOT ELEVATOR



½

**1367**  
Hylin



**1367-1**  
Fig. 1  
4 mm



**1367-2**  
Fig. 2  
3 mm



**1367-3**  
Fig. 3  
3 mm Left



**1367-4**  
Fig. 4  
3 mm Right



½

**READ**



**1367-5**  
Read



**1367-6**  
Coleman  
Hospital



**1367-7**  
Coleman  
Hospital



**1367-8**  
Coleman  
Hospital

# ROOT ELEVATOR

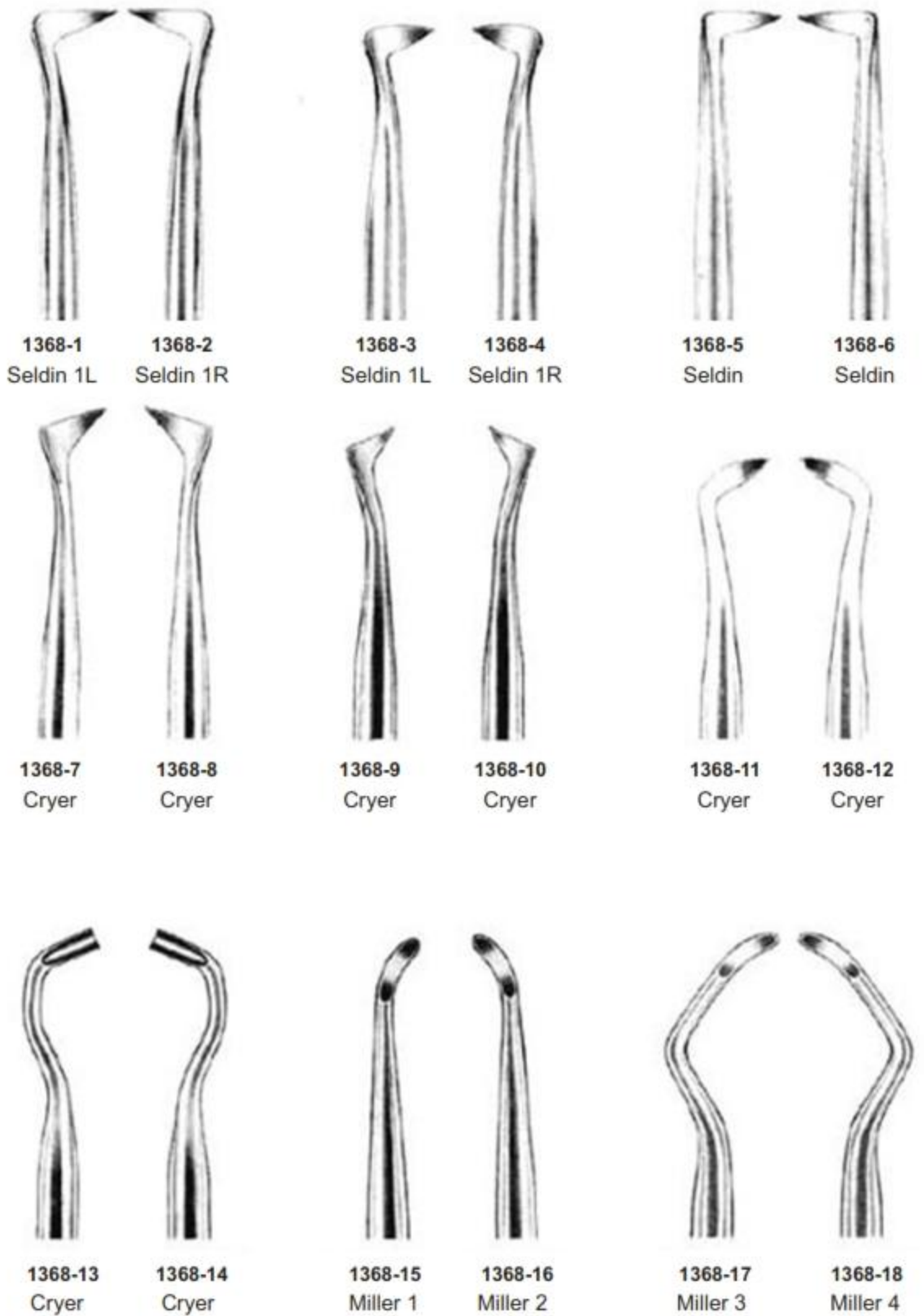

# ROOT ELEVATOR



1369-1  
Apical 302



1369-2  
Apical 303



1369-3  
Apical 304



1369-4  
Apical 12A



1369-5  
Apical 12S



1369-6  
Apical 34



1369-7  
Flohr



1369-8  
Flohr



1369-9  
Flohr



1369-10  
Flohr



1369-11  
Flohr



1369-12  
Flohr



1369-13  
Cryer 3A



1369-14  
Seledin 2



1369-15  
Cryer 12



1369-16  
Seledin 5



1369-17  
Crane Pick



# ROOT ELEVATOR

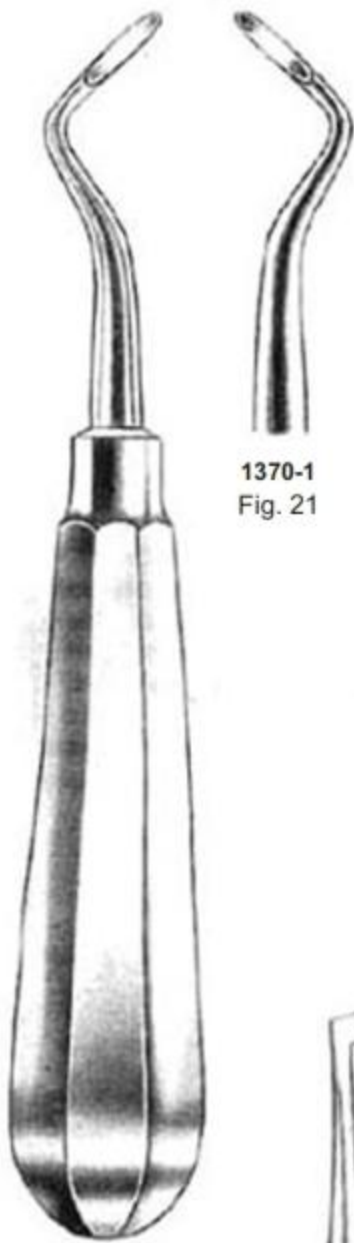

1370  
Miller



1370-1  
Fig. 21

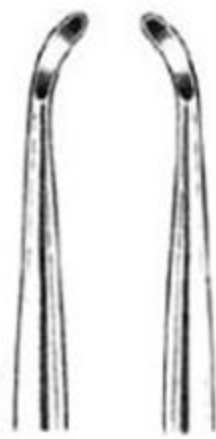

1370-2  
Fig. 22



1370-3  
Fig. 23



1370-4  
Fig. 24



1370-5  
Fig. 25

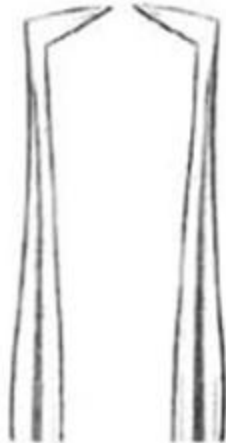

1370-6  
Fig. 26



1370-7  
Fig. 27



1370-8  
Fig. 28



1370-9  
Fig. 29



1370-10  
Fig. 30



1370-11  
Fig. 31



# ELEVATORS PLASTIC HANDLES

1371  
Root Elevator, Plastic Handle, Set of 10 Pcs

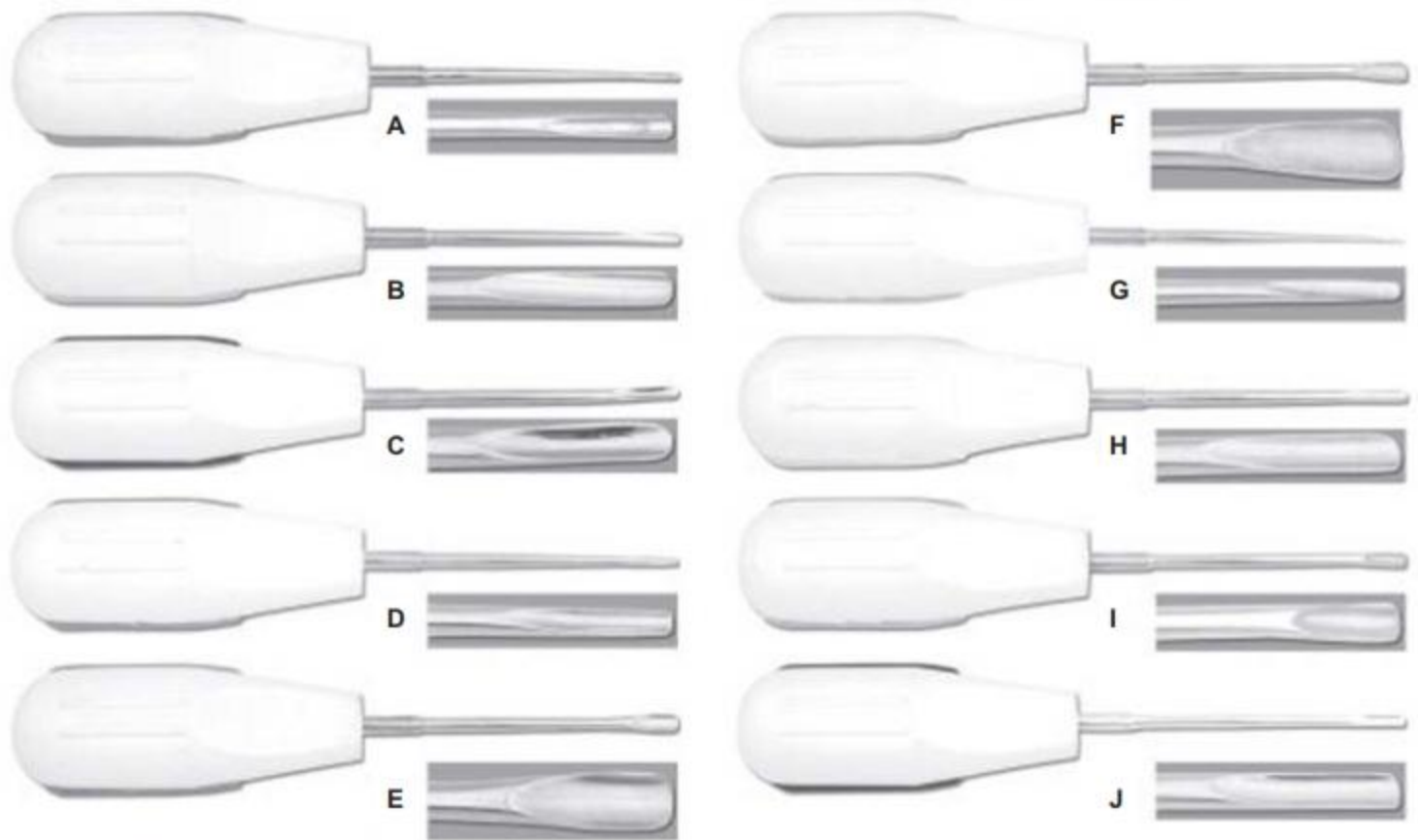

1372  
Root Elevator, Plastic Handle, Set of 5 Pcs

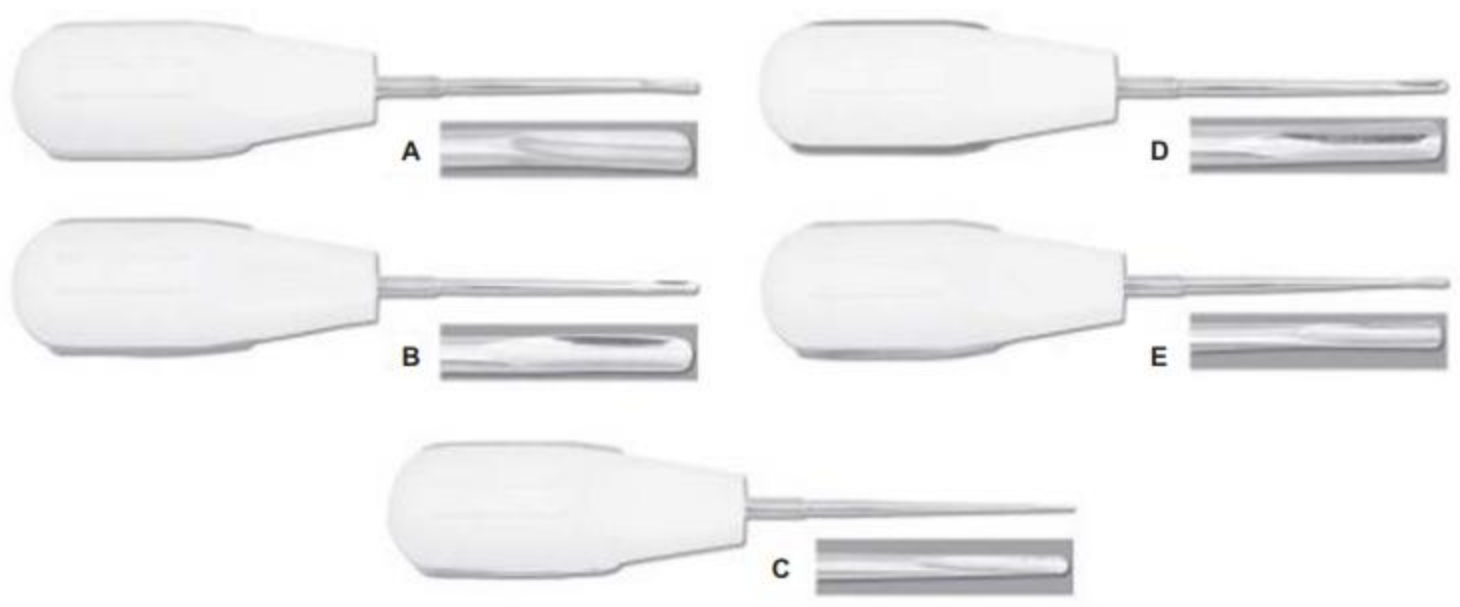

# SCALPEL HANDLES



**1483**  
Scalpel Handle Angle Of Blade Adjusts To Easily Get Around Corners  
Adjustment Sets Blade From Straight To Back Angled  
Locks In At 90°, 60°, 30°, Straight, -30°, -60° Angles



**1484**  
Scalpel Handle  
Fig. 5

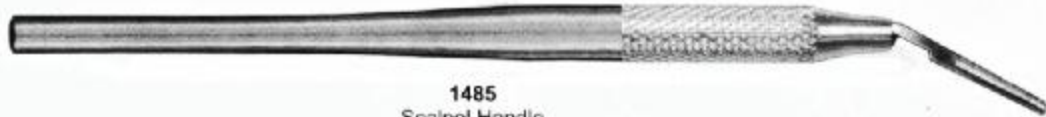

**1485**  
Scalpel Handle  
Curved



**1486**  
Fig. 3L



**1487**  
Fig. 7



**1488**  
Scalpel Handle  
Fig. 4L, Curved  
20 cm



**1489**  
Fig. 3



**1490**  
Fig. 3G



**1491**  
Fig. 4



**1492**



**1493**  
Scalpel Handle  
4 D 14.0 cm



**1494**  
Mess Holders



**1495**  
Gouge  
Blade Handle  
Fig. 2 / 11.5 cm

# HANDLES

Handle For Mouth Mirrors, Probes, Explorers, Excavators, Carvers, Curettes & Scalers



**1496**

Handle No. 2 Standard Single Ended



**1497**

Handle Single Ended



**1498**

Handle Single Ended



**1499**

Handle Single Ended



**1500**

Octagonal Double Ended



**1501**

Octagonal Double Ended



**1502**

Octagonal Double Ended



**1503**

Handle No. 2 (Standard Double Ended)



**1504**

Octagonal Double Ended



**1505**

Tactile Tone Double Ended



**1506**

Tactile Tone Double Ended

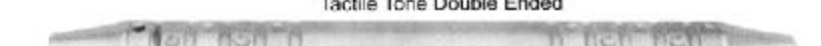

**1507**

Tactile Tone Double Ended

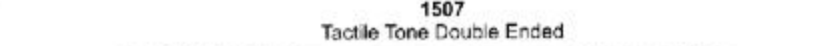

**1508**

Handle, Double Ended

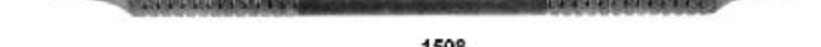

**1509**

Double Ended



**1510**

Tactile Tone Double Ended

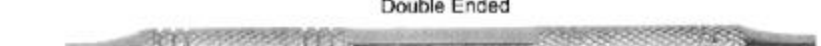

**1511**

Tactile Tone Double Ended



**1511**

Tactile Tone Double Ended

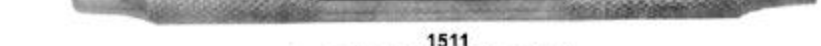

# SCALPEL HANDLES



**1483**  
 Scalpel Handle Angle Of Blade Adjusts To Easily Get Around Corners  
 Adjustment Sets Blade From Straight To Back Angled  
 Locks In At 90°, 60°, 30°, Straight, -30°, -60° Angles



**1484**  
 Scalpel Handle  
 Fig. 5



**1485**  
 Scalpel Handle  
 Curved



**1486**  
 Fig. 3L



**1487**  
 Fig. 7



**1488**  
 Scalpel Handle  
 Fig. 4L, Curved  
 20 cm



**1489**  
 Fig. 3



**1490**  
 Fig. 3G



**1491**  
 Fig. 4



**1492**



**1493**  
 Scalpel Handle  
 4 D 14.0 cm



**1494**  
 Mess Holders



**1495**  
 Gouge  
 Blade Handle  
 Fig. 2 / 11.5 cm

# HANDLES & MOUTH MIRRORS

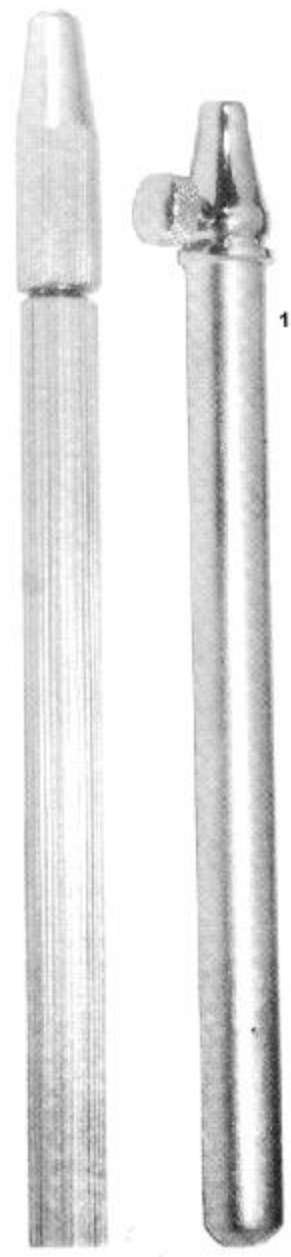

**1512**  
Hollow Handle  
Fig.1

**1513**  
Hollow Handle  
Fig.2

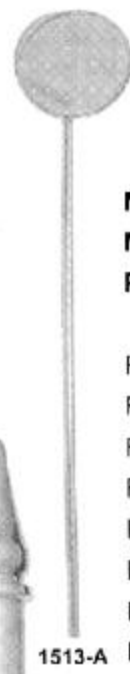

1513-A

**Mouth Mirrors,**  
**Magnifying 1513-A**  
**Plain 1512-B**

Fig. 00	Ø	8 mm
Fig. 0	Ø	10 mm
Fig. 1	Ø	14 mm
Fig. 2	Ø	16 mm
Fig. 3	Ø	18 mm
Fig. 4	Ø	20 mm
Fig. 5	Ø	22 mm
Fig. 6	Ø	24 mm
Fig. 7	Ø	26 mm
Fig. 8	Ø	28 mm
Fig. 9	Ø	30 mm
Fig. 10	Ø	32 mm



DS1520

Double Sided Front Surface  
mouth mirror

			<p>Plane</p>		
<p><b>1514</b> Fig.6 Ø 26 mm</p>	<p><b>1515</b> Fig.5 Ø 24 mm</p>	<p><b>1516</b> Fig.4 Ø 22 mm</p>	<p>Magnifying</p>		
<p><b>1517</b> Fig.6 Ø 26 mm</p>	<p><b>1518</b> Fig.5 Ø 24 mm</p>	<p><b>1519</b> Fig.4 Ø 22 mm</p>	<p>Front surface</p>		
<p><b>1520</b> Fig.6 Rhodium Ø 26 mm Front surface</p>	<p><b>1521</b> Fig.5 Rhodium Ø 24 mm Front surface</p>	<p><b>1522</b> Fig.4 Rhodium Ø 22 mm Front surface</p>	<p>Plane</p>		
<p>With cone - socket</p>			<p>Magnifying</p>		
<p><b>1523</b> Fig.6 Ø 26 mm</p>	<p><b>1524</b> Fig.5 Ø 24 mm</p>	<p><b>1525</b> Fig.4 Ø 22 mm</p>	<p><b>1526</b> Fig.6 Ø 26 mm</p>	<p><b>1527</b> Fig.5 Ø 24 mm</p>	<p><b>1528</b> Fig.4 Ø 22 mm</p>

# HANDLES & MOUTH MIRRORS



1529



1530



1531



1532



1533



1534



1535  
Parallelometer  
mouth mirror

1536  
Parallelometer  
mouth mirror  
+ handle  
code 2101



1537  
Tactile Tone  
Single Ended



1538  
Handle  
Thompson  
Single Ended



1539  
Hollow Handle



1540  
Hollow Handle  
Stainless  
Steel



1541  
Cone-socket  
Hollow Handle



1542  
Hollow Handle



1543  
Hollow Handle

# SCALERS

## SCALERS - JAQUETTE

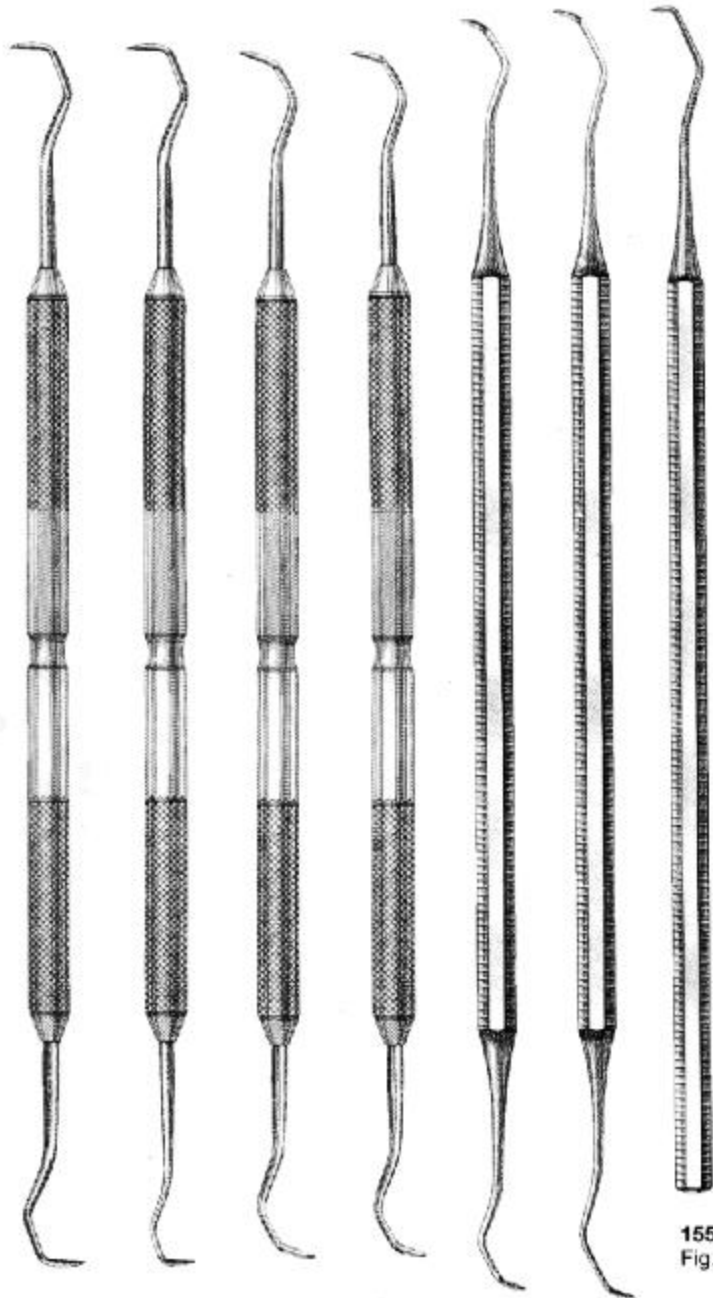

1544 1Y-1Y    1545 1Y-1YS    1546 2Y-3Y    1547 2YS-3YS    1548 2-3    1549 2S-3S

1550 Fig.1

## SCALERS - OCTAGONAL

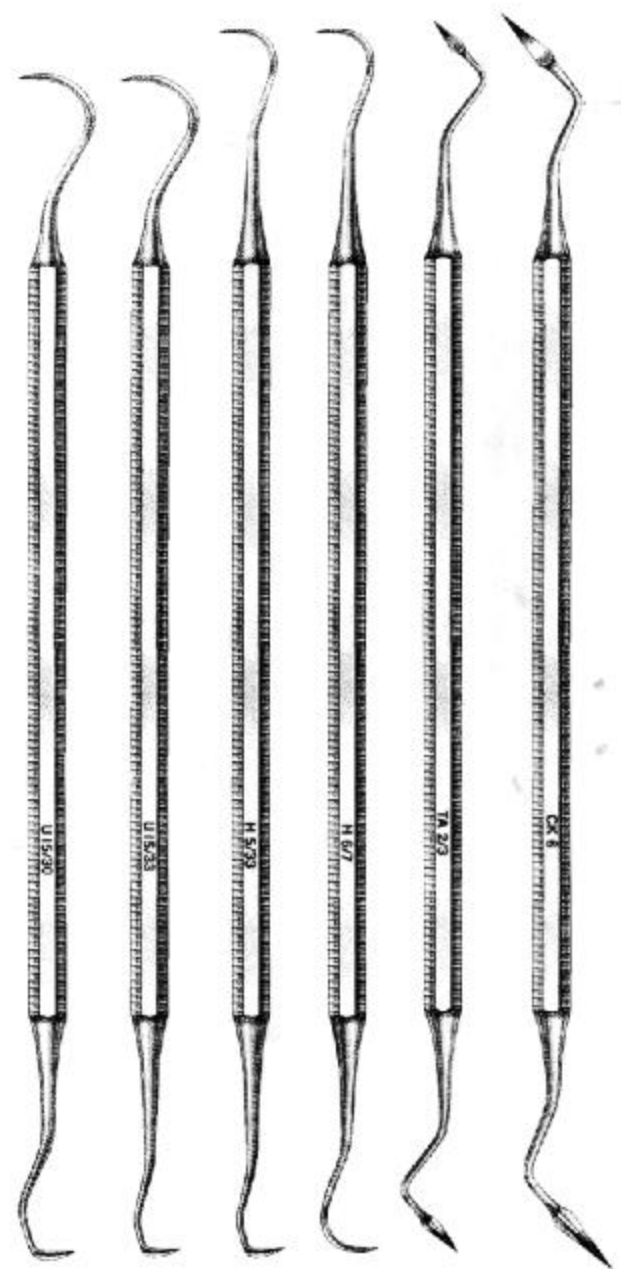

1551 U15-30    1552 U15-33    1553 H5-33    1554 H6-7    1555 Taylor 2-3    1556 CK6

# SCALERS

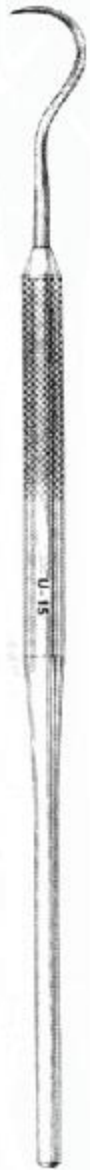

1557  
U15



1558  
No. 3



1559  
No. 12



1560  
WHITESIDE 1-0



1561  
WHITESIDE 2-0



## SCALERS



**1562**  
YAOUNGER/GOOD  
7-8



**1563**  
H5-33



**1564**  
204SD



**1565**  
H6-7



**1566**  
204S



**1567**  
TOWNER/JAQUETTE  
U15-30

# SCALERS



**1568**  
JAQUETTE (33-U15)



**1569**  
JAQUETTE  
2Y-3Y



**1570**  
JAQUETTE  
30-U15



**1571**  
JAQUETTE  
2YS-3YS



**1572**  
JAQUETTE  
33-H5



**1573**  
YOUNGER/GOOD  
7-8



**1574**  
204S



**1575**  
204SD



**1576**  
H6-7



**1577**  
JAQUETTE  
2S-3S



**1578**  
JAQUETTE  
1Y-1YS



**1579**  
JAQUETTE  
2-3

# SCALERS



**1580**  
JAQUETTE (33-U15)



**1581**  
S204



**1583**  
S204S



**1585**  
S204SD



**1587**  
Goldman 6-7



**1589**  
Goldman Fox 21



**1591**  
H5-U15



**1593**  
Jaquette 34-35



**1595**  
Thompson Jr.



**1597**  
UT107-108



**1599**  
UP128



**1582**  
Jack-Nebraska

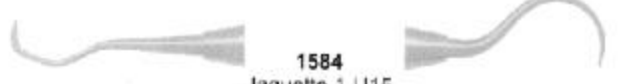

**1584**  
Jaquette 1-U15



**1586**  
Jaquette 2-3



**1588**  
Jaquette 2S-3S



**1590**  
Jaquette 30-U15



**1592**  
Jaquette 30-33



**1594**  
Jaquette 31-32



**1596**  
Jaquette 33-H5



**1598**  
U 6-7



**1600**  
128L

# EXPLORERS

## Explorers Double Ended - Octagonal

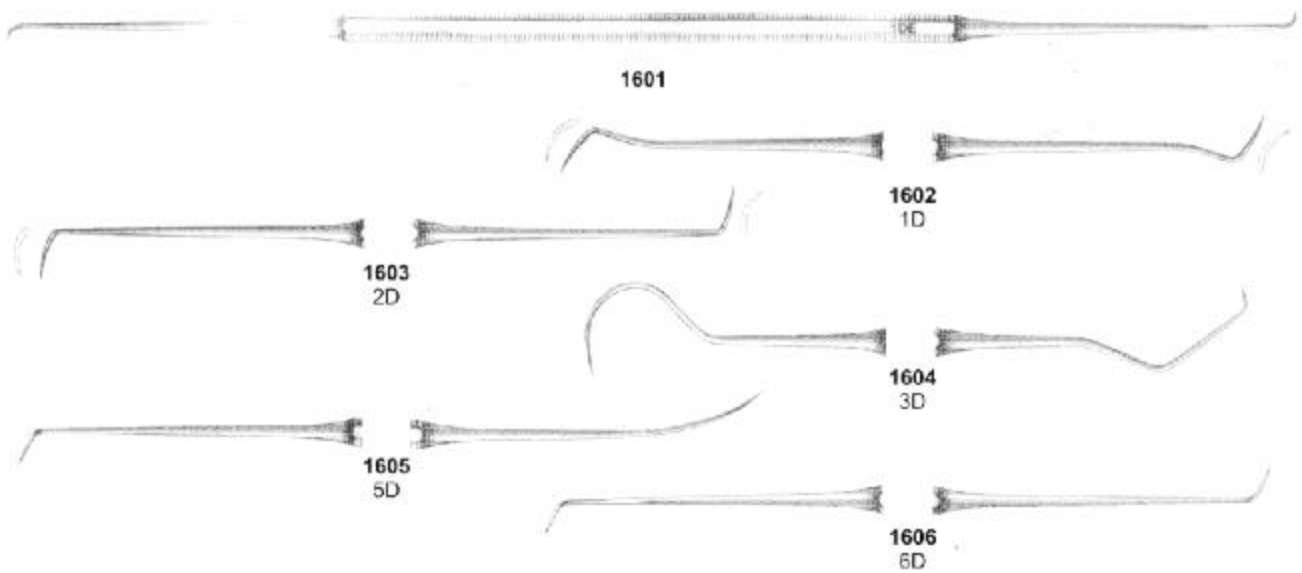

## Explorers Double Ended - Standard

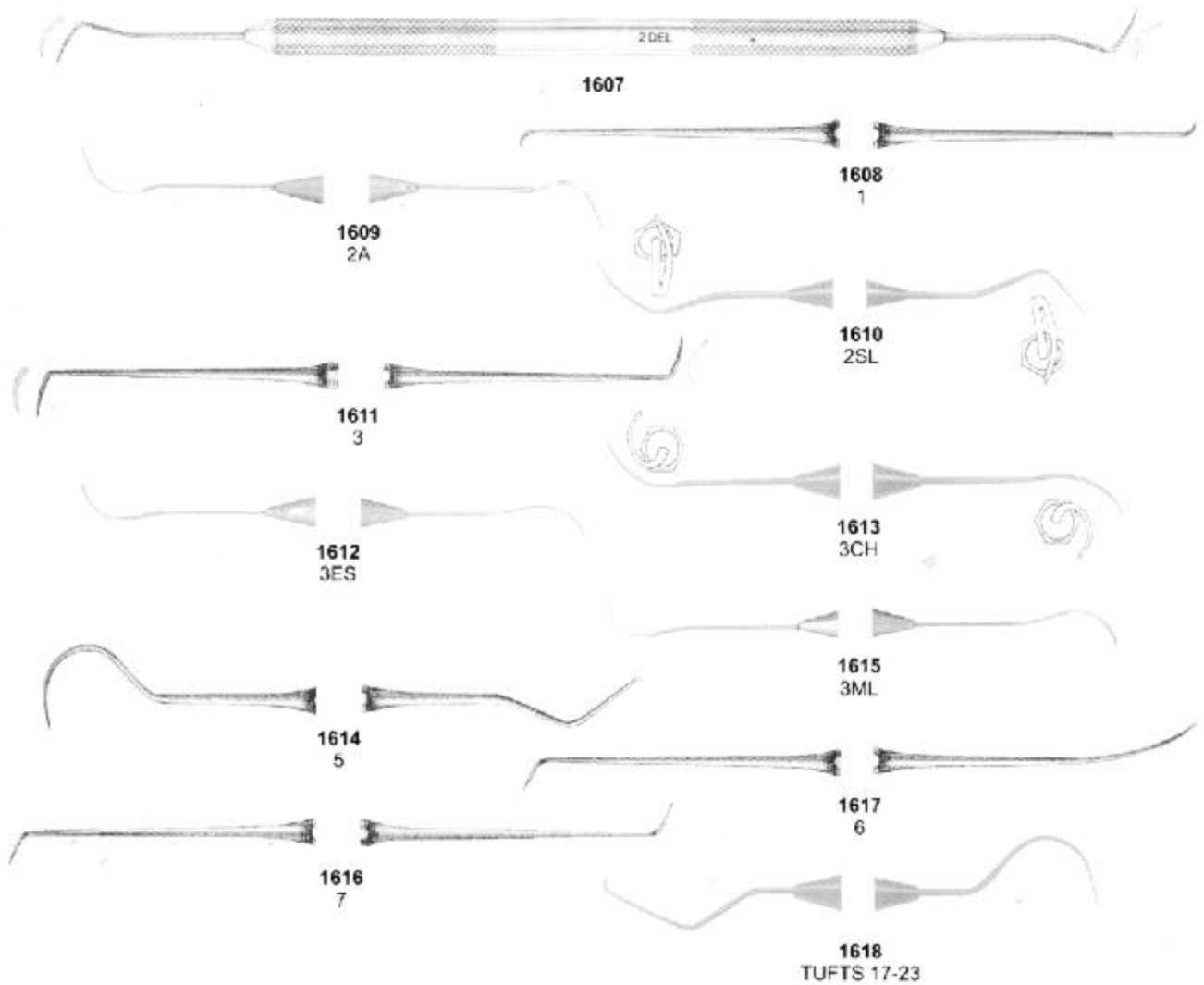

Explorers Double Ended Tactile Tone

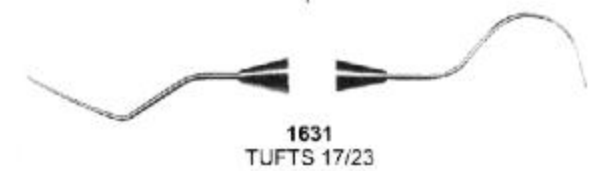
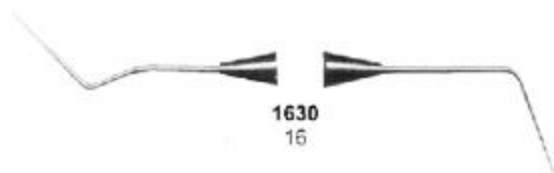
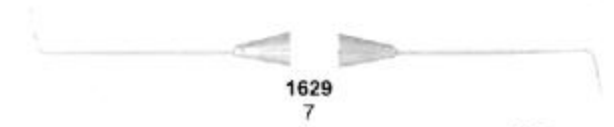
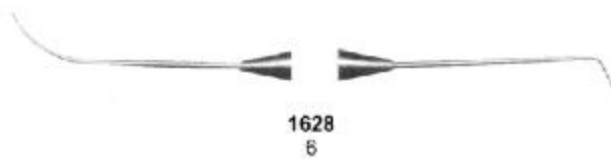
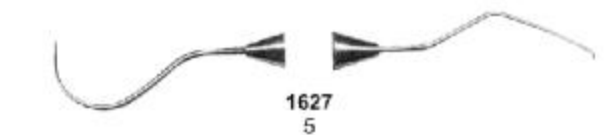
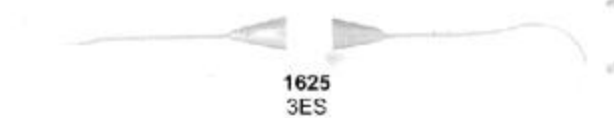
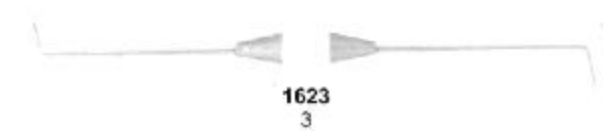
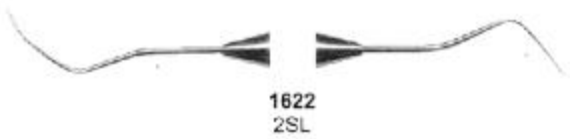
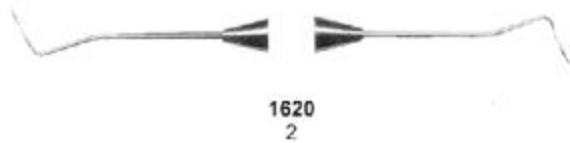
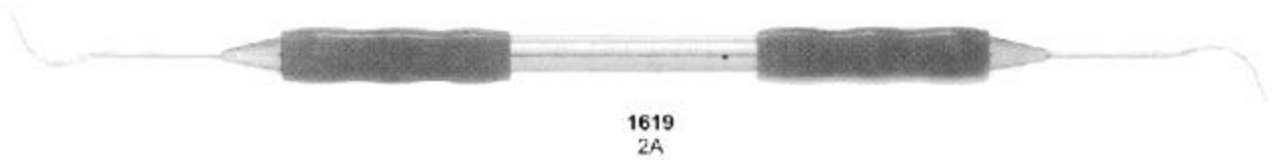

Explorers Single Ended - Octagonal



1632  
Fig. 3A



1633  
Fig. 6



1634  
Fig. 7



1635  
Fig. 17



1636  
Fig. 23

Explorers Single Ended - Standard



1637  
Fig. 3A



1638  
Fig. 6



1639  
Fig. 7



1640  
Fig. 17



1641  
Fig. 23

Probe / Explorer - Octagonal



1642  
GF-17

Double Ended Probe - Octagonal

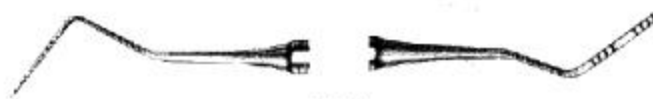

1643  
GF-18 (1-2)

Probes Double Ended - Standard

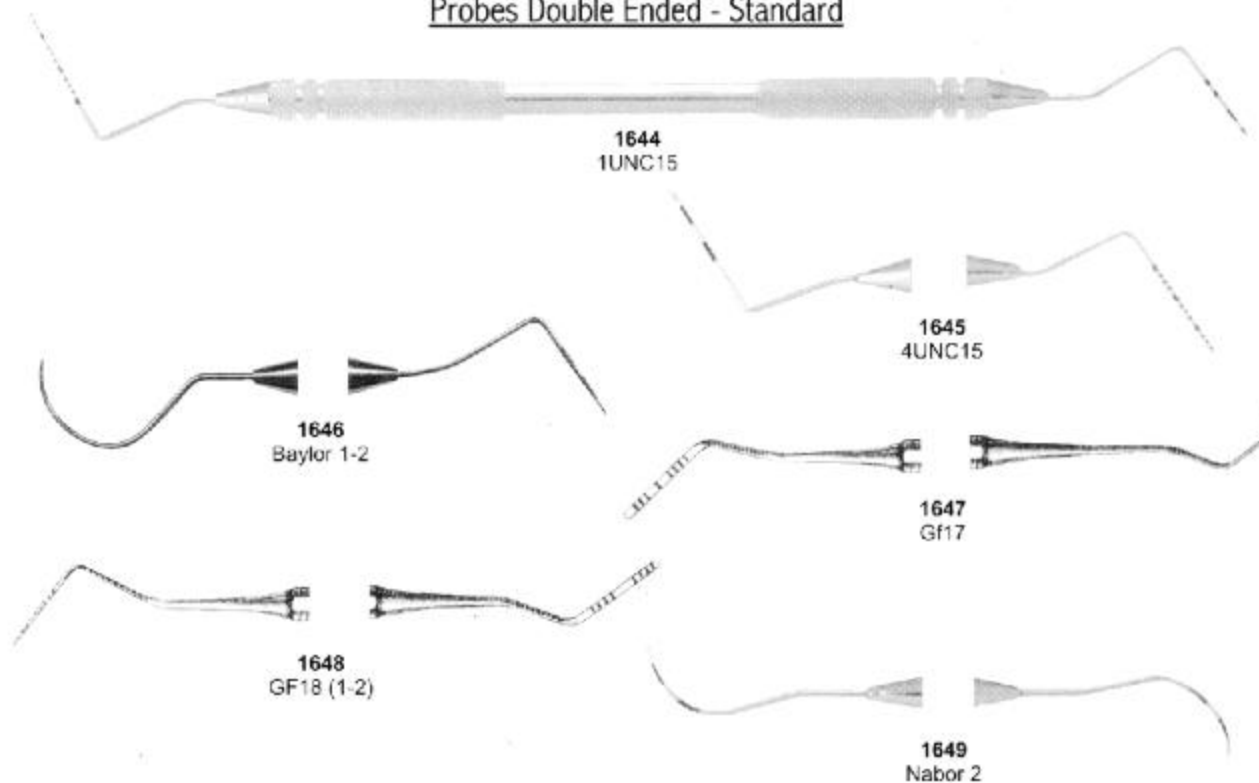

Probes Double Ended - Tactile Tone

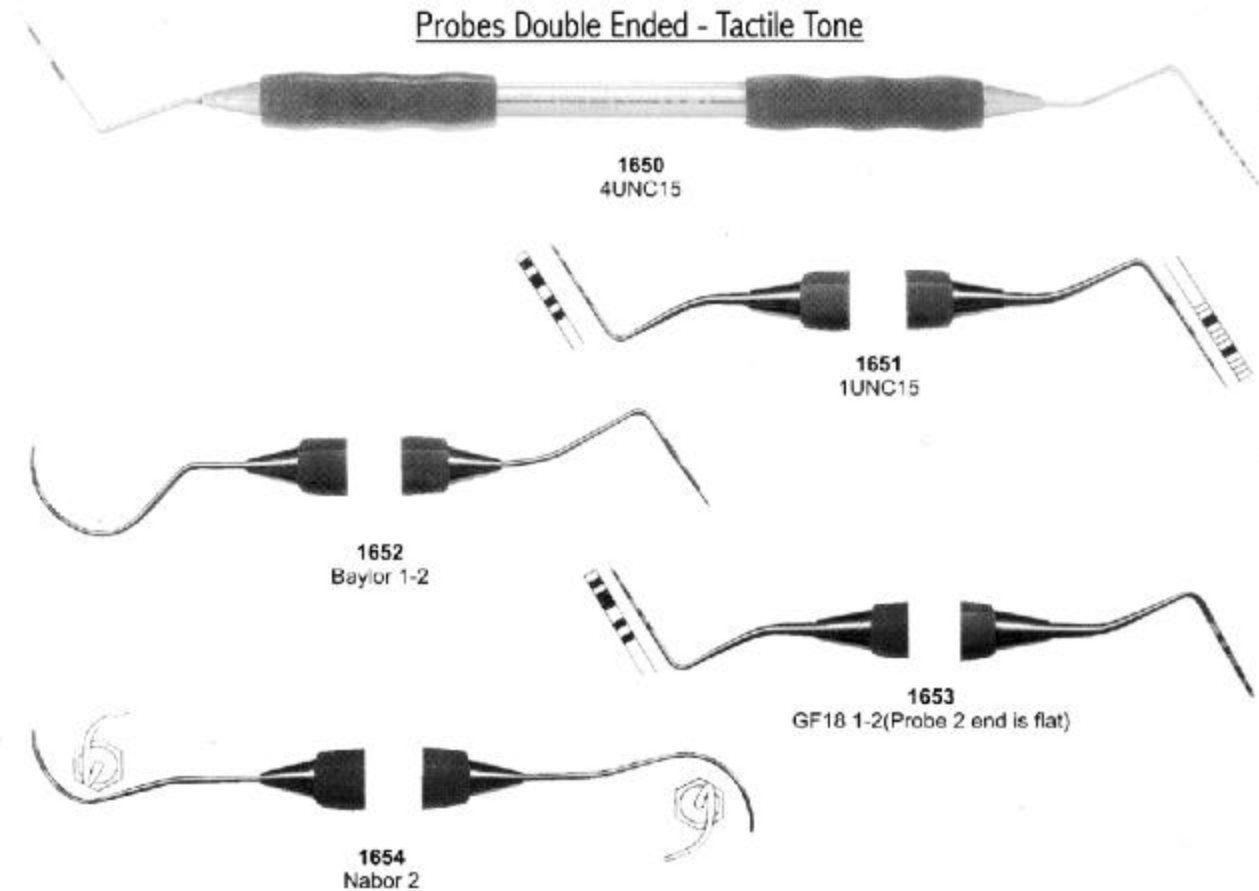

**PROBS**

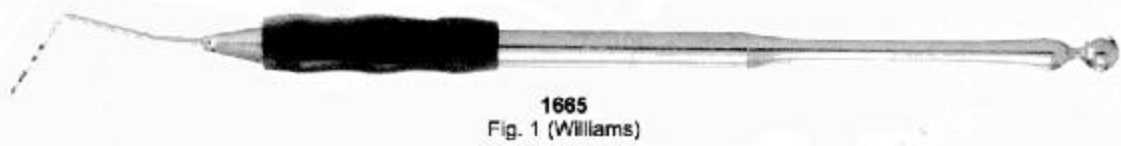
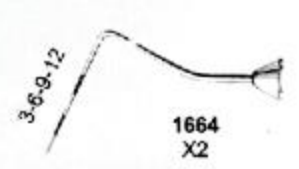
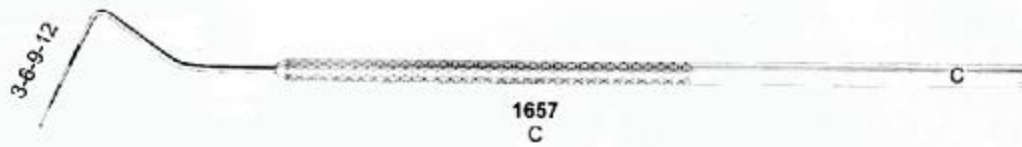
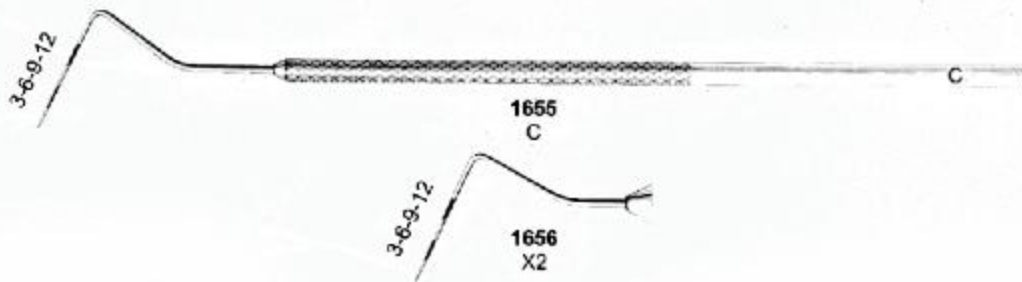



**PROBES DOUBLE ENDED STANDARD**

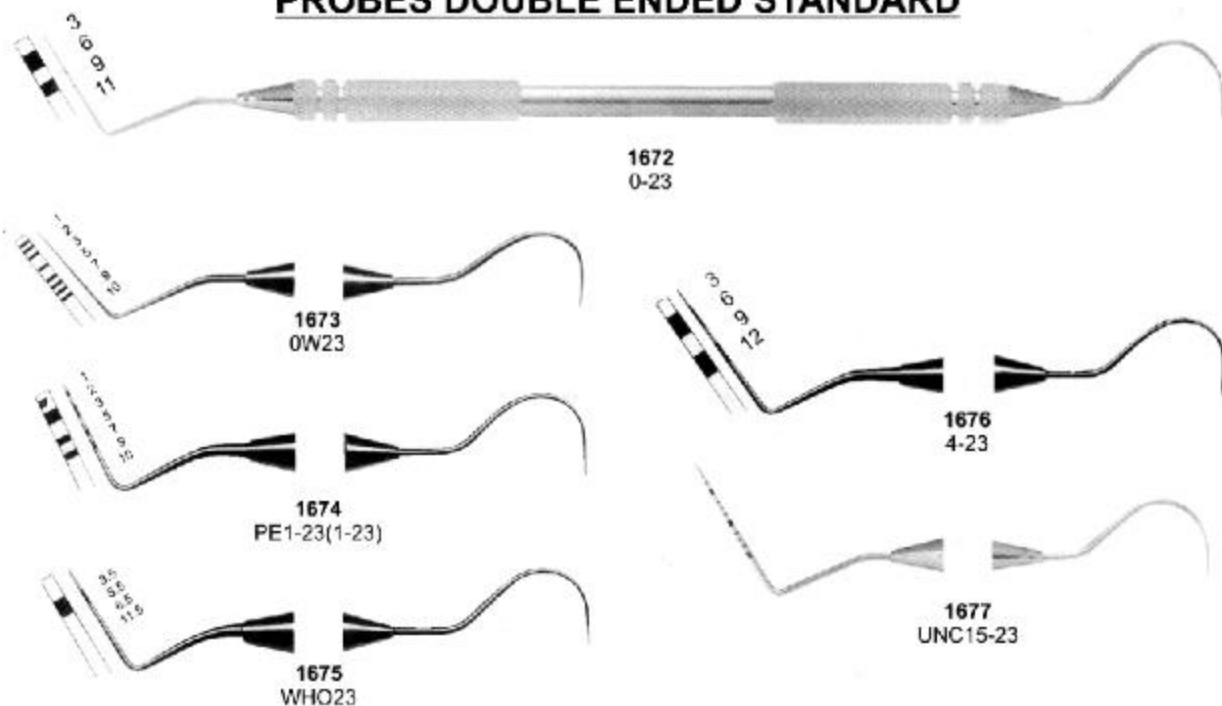

**PROBES DOUBLE ENDED TACTILE TONE**

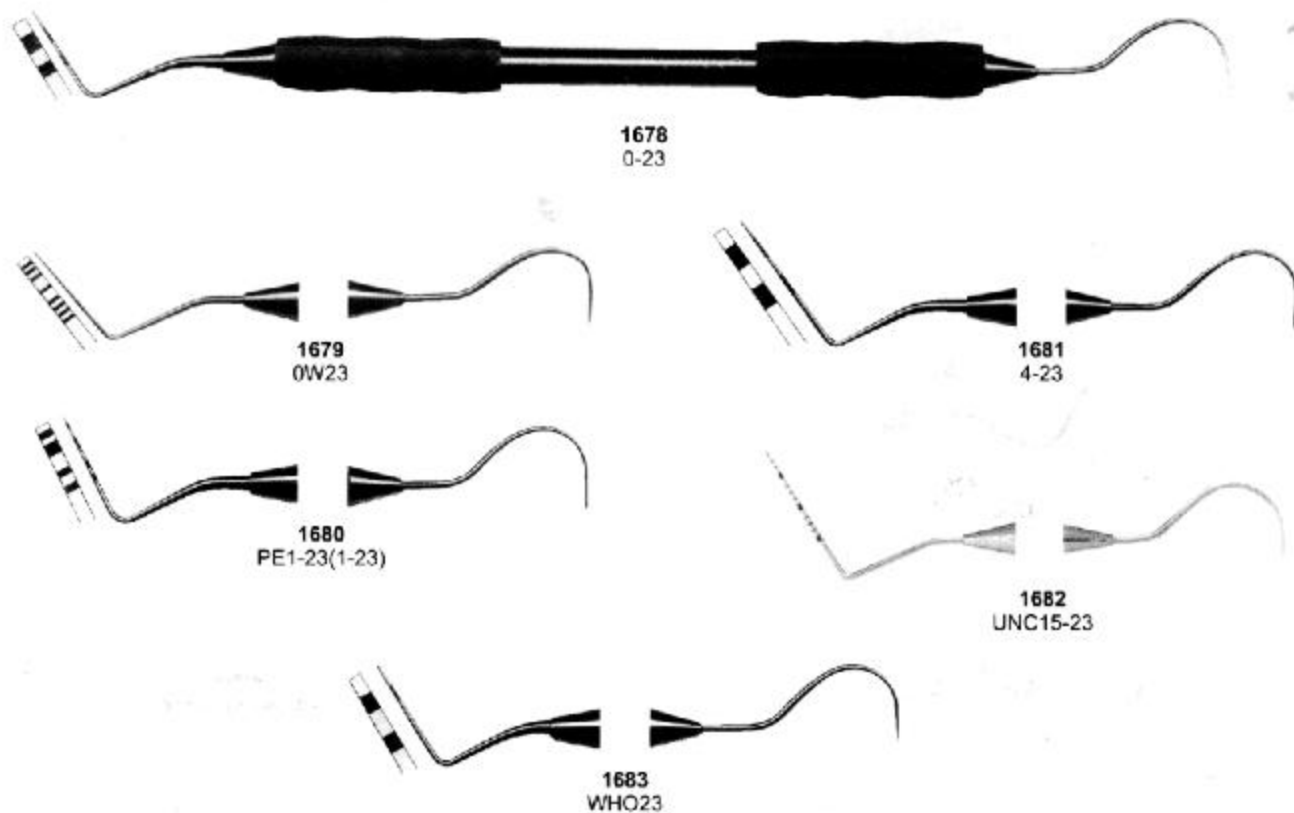

# ENDODONTIC CONDENSERS

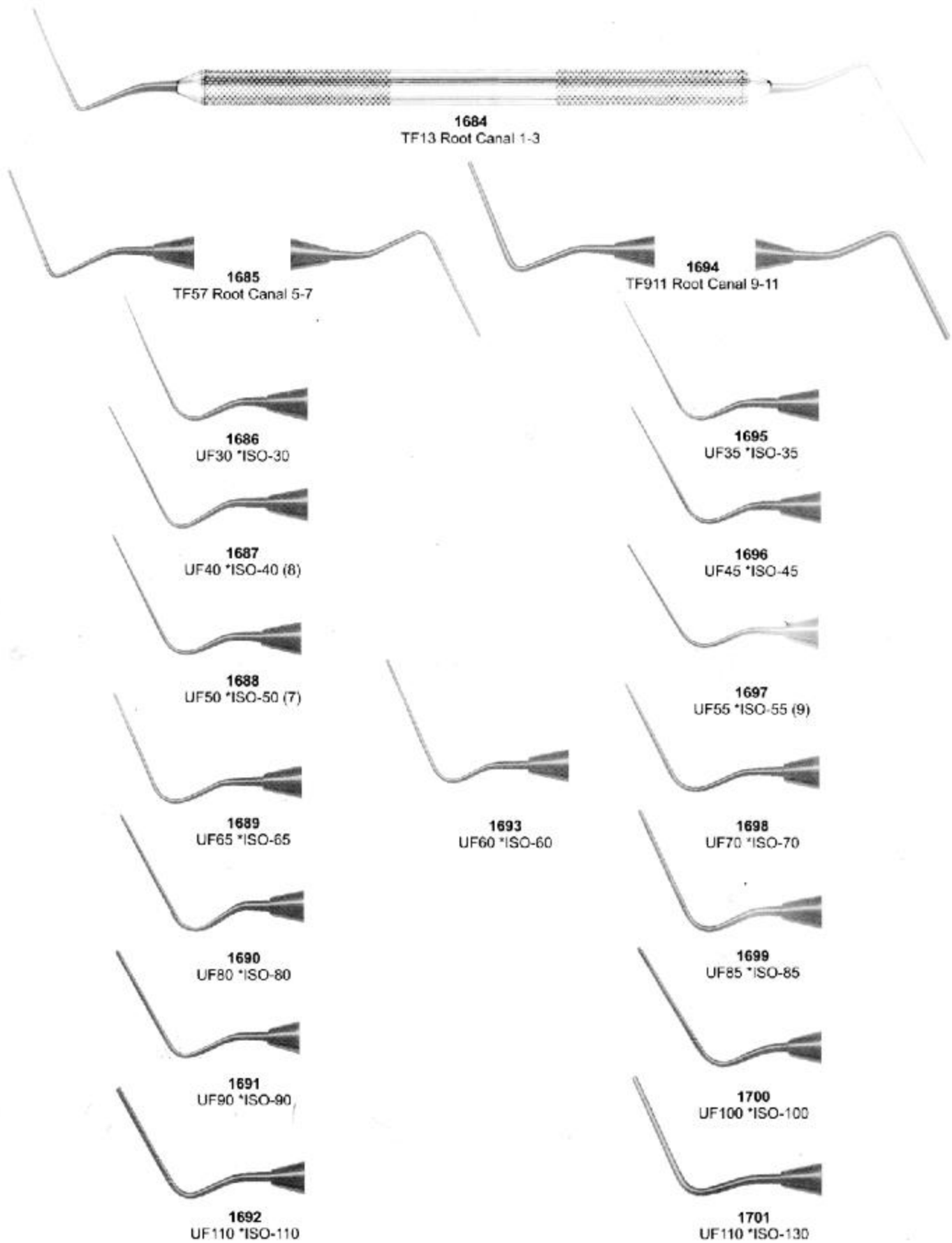

**1684**  
TF13 Root Canal 1-3

**1685**  
TF57 Root Canal 5-7

**1694**  
TF911 Root Canal 9-11

**1686**  
UF30 \*ISO-30

**1695**  
UF35 \*ISO-35

**1687**  
UF40 \*ISO-40 (8)

**1696**  
UF45 \*ISO-45

**1688**  
UF50 \*ISO-50 (7)

**1697**  
UF55 \*ISO-55 (9)

**1689**  
UF65 \*ISO-65

**1693**  
UF60 \*ISO-60

**1698**  
UF70 \*ISO-70

**1690**  
UF80 \*ISO-80

**1699**  
UF85 \*ISO-85

**1691**  
UF90 \*ISO-90

**1700**  
UF100 \*ISO-100

**1692**  
UF110 \*ISO-110

**1701**  
UF110 \*ISO-130

# ENDODONTIC CONDENSERS

## / SPREADERS



1702  
UF120X



1703  
UF45N



1704  
UF60N



1705  
UF80N



1706  
UF100X



1707  
UE25 R-25



1708  
UE30 R-30



1709  
UE35 R-35



1710  
UE40 R-40



1711  
UE45 R-45



1712  
UE50 R-50



1713  
UF120X



1714  
UF140X



1715  
TFD3545N



1716  
TFD6080N



1717  
UE55 R-55



1718  
UE60 R-60



1719  
UE25N R-25

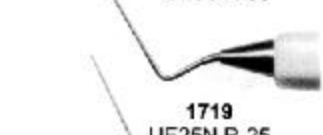

1720  
UE30N R-30



1721  
UE40N R-40

# OBTURATION INSTRUMENTS

**1722**  
No. D11

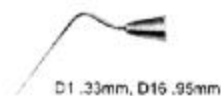

D1 .33mm, D16 .95mm

**1723**  
No. D11T



D1 .24mm, D2 .84mm

**1724**  
No. KR1



D1 .23mm, D2 .61mm

**1725**  
No. 25S



D1 .26mm, D2 .53mm

**1726**  
No. W1S



D1 .25mm, D16 .55mm

**1727**  
No. W2S

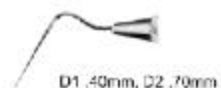

D1 .40mm, D2 .70mm



**1728**  
Lucks No.1



**1729**  
Lucks No.2



**1730**  
Lucks No.3



**1731**  
Lucks No.4



**1732**  
No. 5, D(1mm).50mm, .55mm D(5mm)  
D(16mm), .85mm, .75mm D(16mm)



**1733**  
No. 7, D(1mm).70mm, .50mm D(5mm)  
D(16mm), 1.00mm, .75mm D(16mm)



**1734**  
No. 9, D(1mm)1.00mm, .63mm D(5mm)  
D(16mm), 1.30mm, .75mm D(16mm)



**1735**  
No. 11, D(1mm)1.20mm, .63mm D(5mm)  
D(16mm), 1.50mm, .75mm D(16mm)



**1736**  
No. 1 (D1 .35mm, D16 .75mm)



**1737**  
No.2 D1 .55mm, D16 .85mm

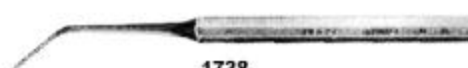

**1738**  
No.3 D1 .85mm, D16 1.15mm

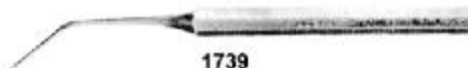

**1739**  
No.4 D1 1.00mm, D16 1.30mm



**1740**  
No.1-3 - D1 .25mm/D1 .35mm



**1741**  
No.3-5 - D1 .35mm/D1 .55mm



**1742**  
No.5-7 - D1 .55mm/D1 .70mm

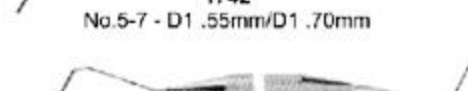

**1743**  
No.9-11 - D1 1.00mm/D1 1.20mm

# EXCAVATORS

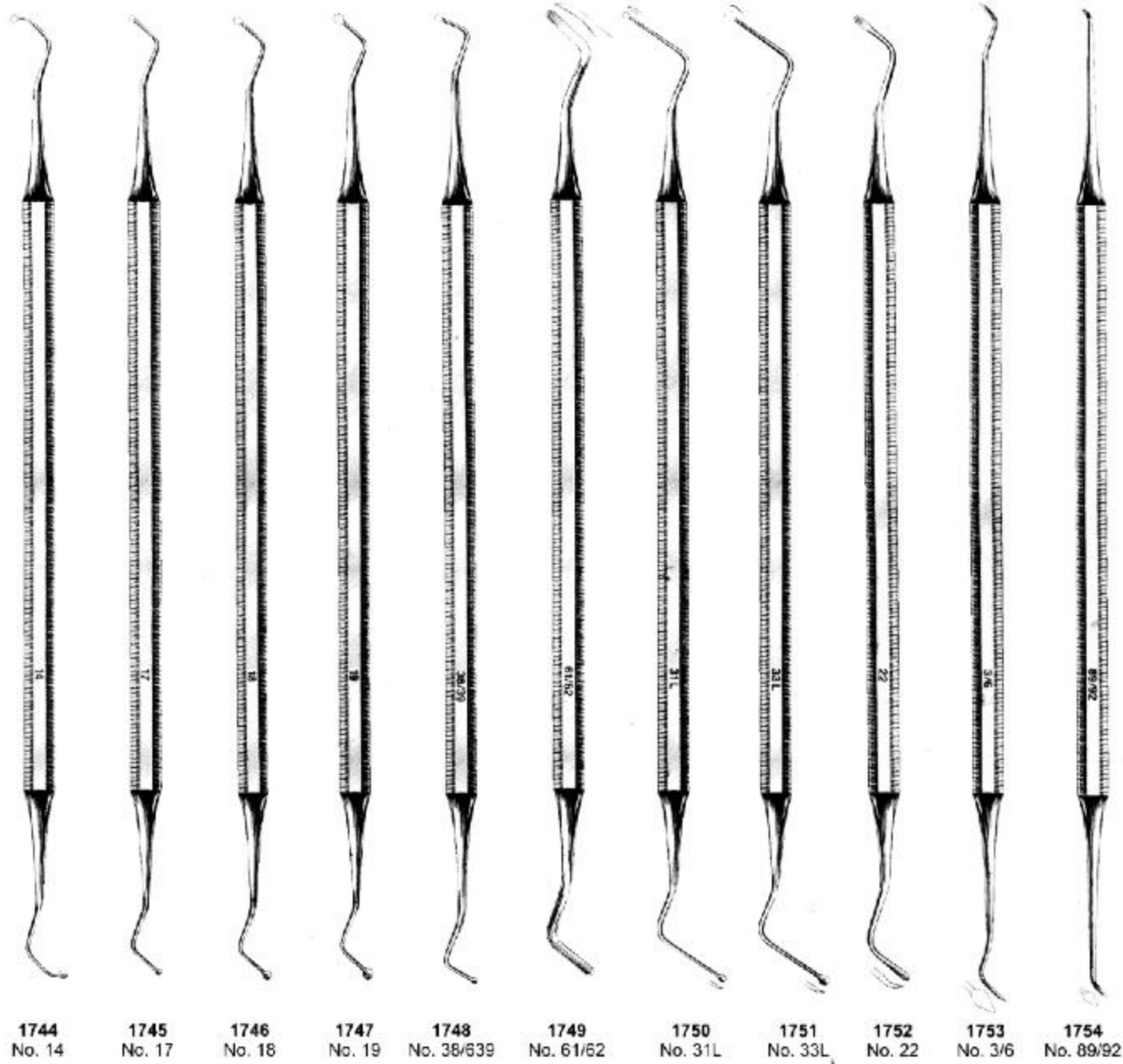

1744  
No. 14

1745  
No. 17

1746  
No. 18

1747  
No. 19

1748  
No. 38/639

1749  
No. 61/62

1750  
No. 31L

1751  
No. 33L

1752  
No. 22

1753  
No. 3/6

1754  
No. 89/92

# EXCAVATORS



**1755**  
1mm Discoid (10-7-14)



**1756**  
1mm Discoid (38-39) (11.5-7-14)



**1757**  
E2 Discoid (15-9-15)



**1758**  
1.5mm Discoid (15-8-14)



**1759**  
E3 Discoid (25-9-15)



**1760**  
2mm Discoid (20-9-14)



**1761**  
1.5mm Spoon (15-8-14)



**1762**  
E1 Discoid (12-9-15)



**1763**  
2mm Spoon (20-9-14)



**1764**  
17 Tear-Drop



**1765**  
19 Tear-Drop



**1766**  
18 Tear-Drop



**1767**  
20 Tear-Drop



# EXCAVATORS

## / EXPLORERS / PROBES

### Excavators

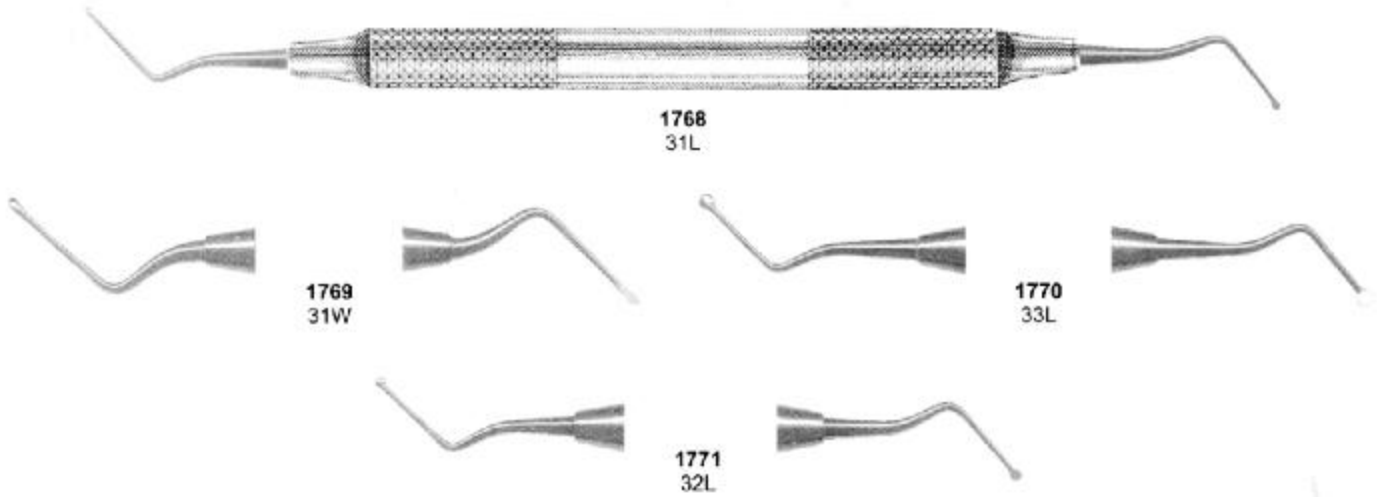

### Explorers / Probes

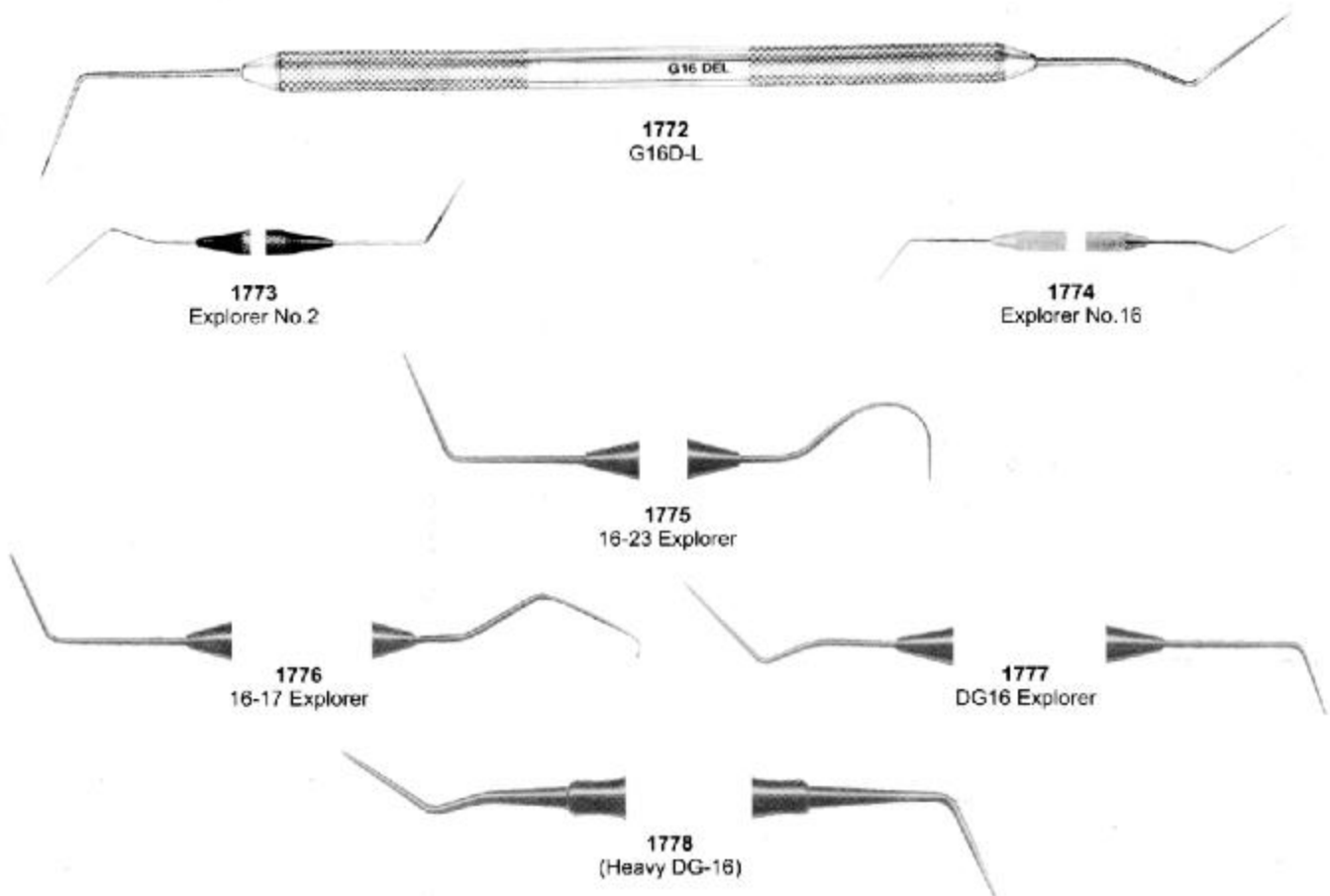

# EXPLORERS

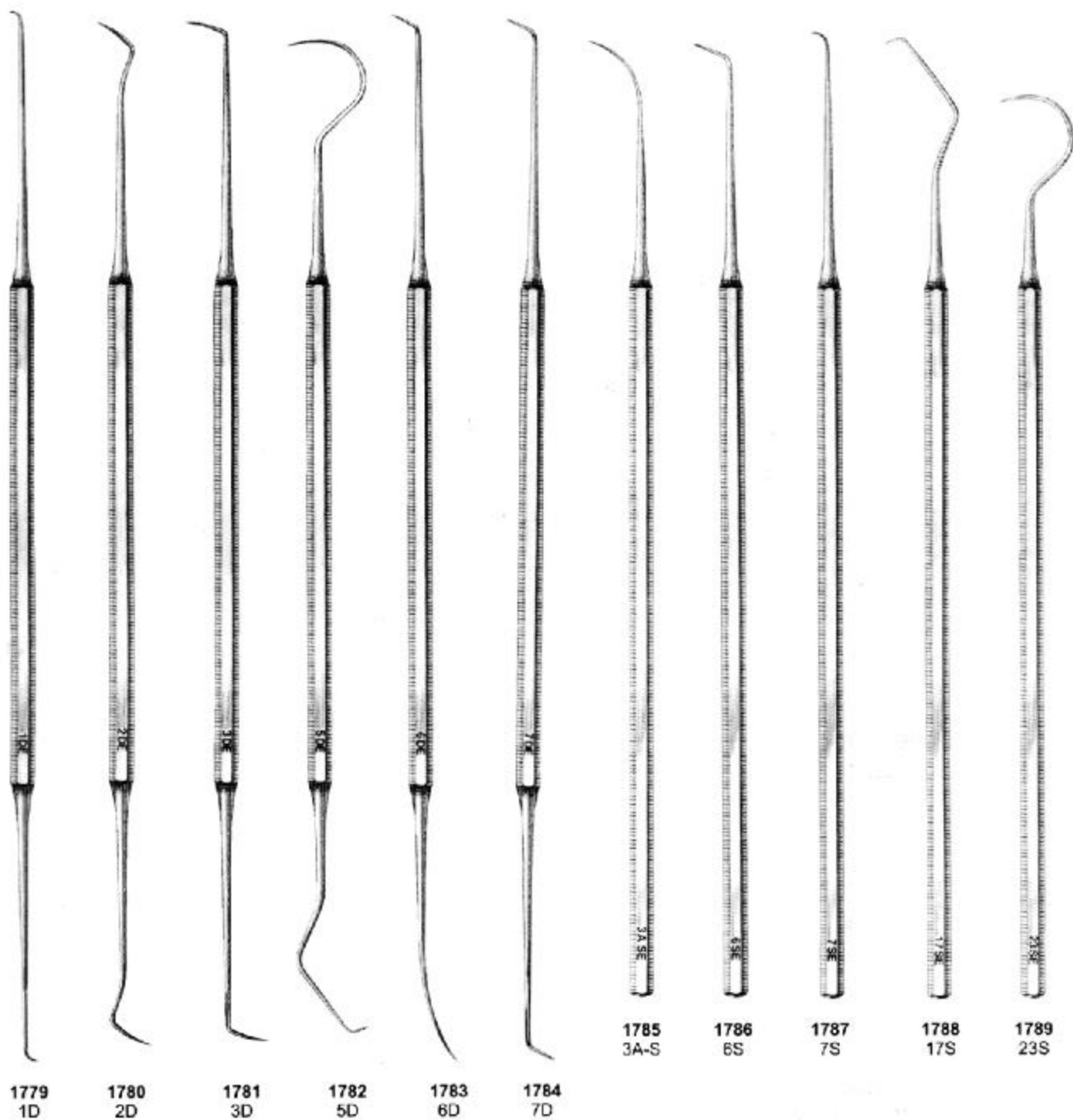



# EXPLORERS

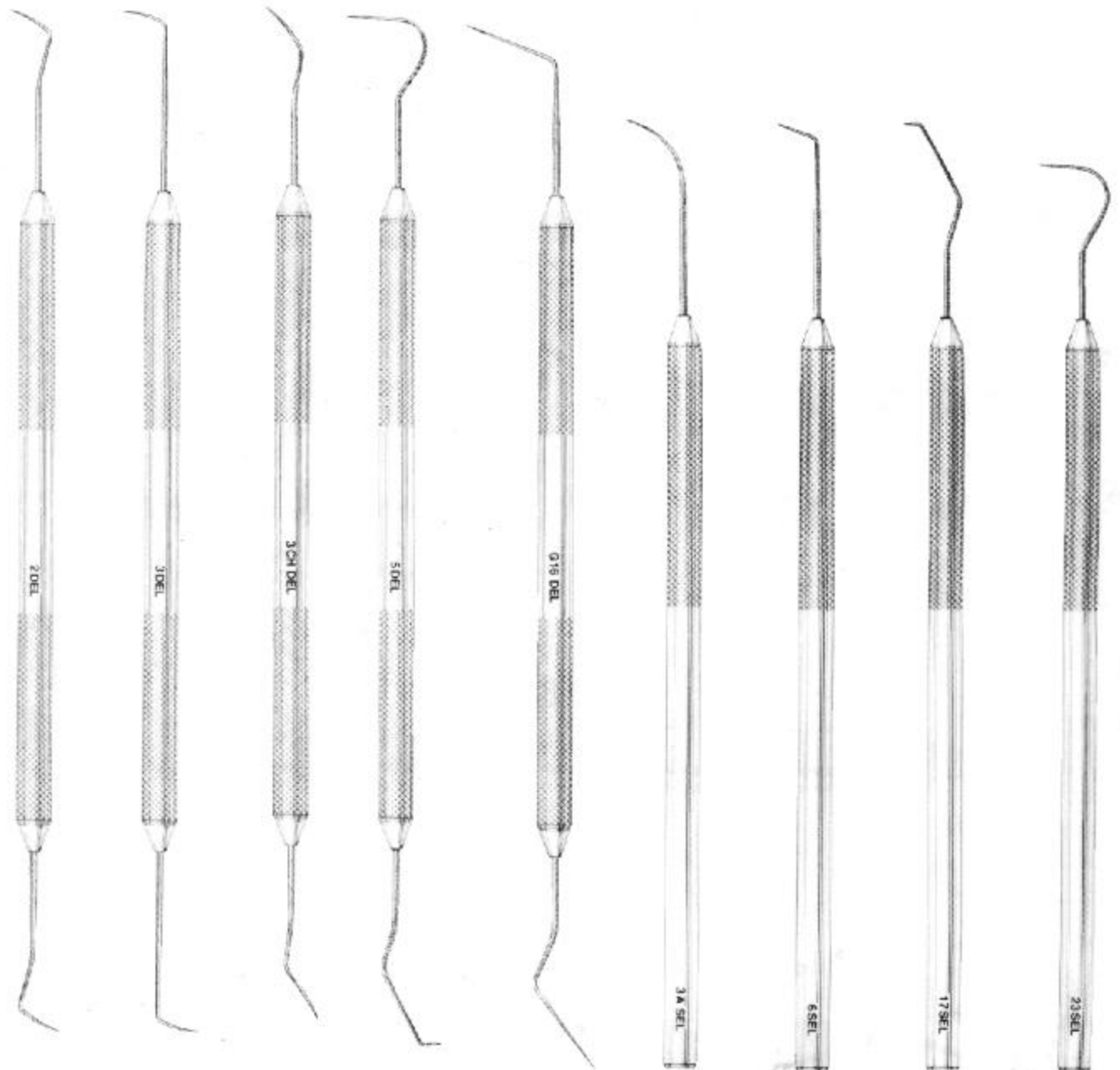

**1790**  
No. 2D-L

**1791**  
No. 3D-L

**1792**  
No. 3CHD-L

**1793**  
No. 5D-L

**1794**  
No. G16D-L

**1795**  
No. 3AS-L

**1796**  
No. 6S-L

**1797**  
No. 17S-L

**1798**  
No. 23S-L

# EXPLORERS

## / PROB COMBINATIONS



**1799**  
Gf17 Probe/Explorer



**1800**  
PE 1-23 Probe/Explorer

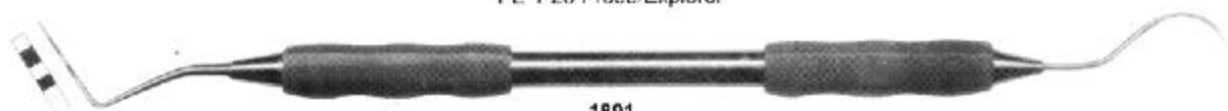

**1801**  
Probe 0 / 23 Explorer (fine)



**1802**  
Probe 1 / 23 Explorer



**1804**  
Probe 4 / 23 Explorer



**1803**  
Probe OW / 23 Explorer

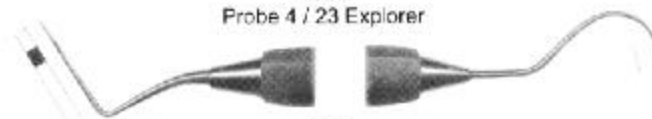

**1805**  
Ball Tip Probe WHO / 23 Explorer

## PROBES



**1806**  
Gf16 Probe



**1807**  
"C" Probe



**1808**  
X2 Probe



**1809**  
1-2 (Probe 2 end is flat)



**1810**  
1 LNC 15



**1811**  
4 SE

# CORD PACKERS

## / HATCHETS / HOES

### CORD PACKERS

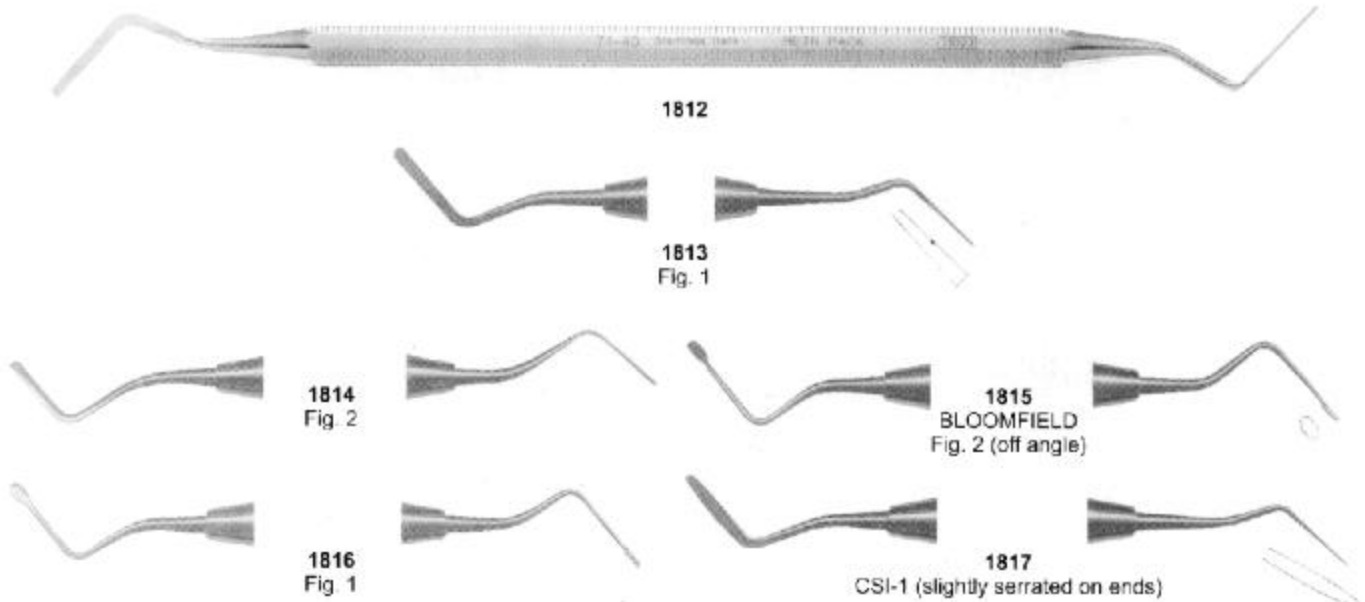

### HATCHETS

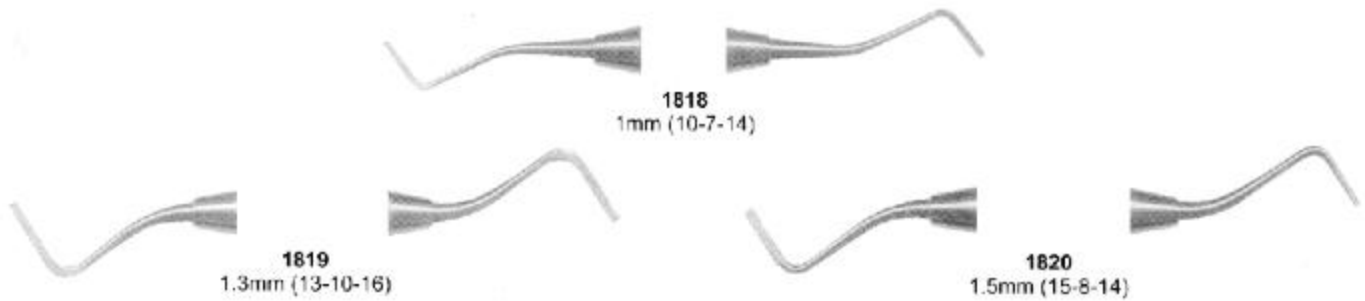

### HOES

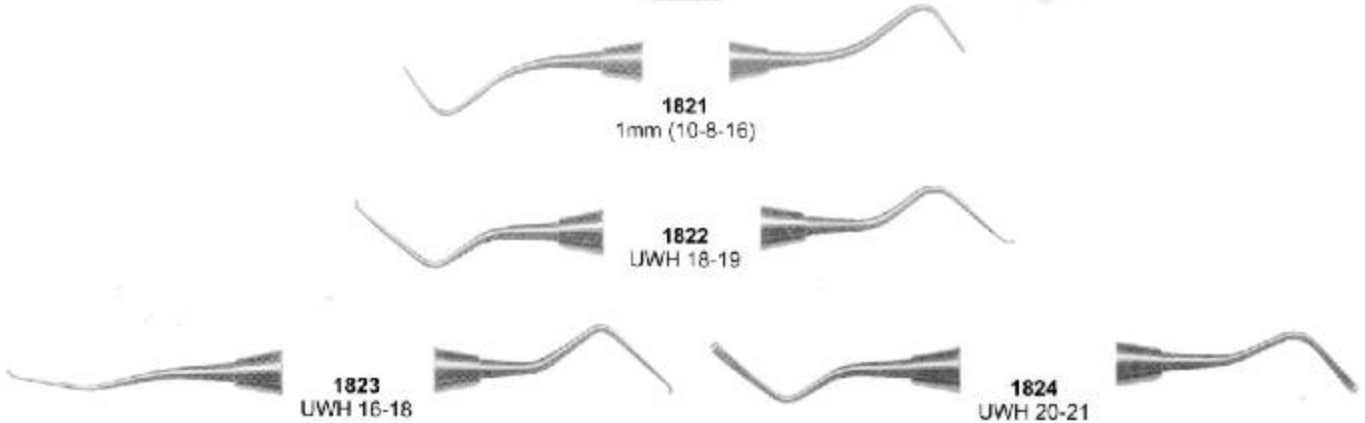

## P.K. THOMAS WAXING

### & GROCEY CURETTES SET



**1825**  
P.K.Thomas 1



**1826**  
P.K.Thomas 2



**1827**  
P.K.Thomas 3



**1828**  
P.K.Thomas 4



**1829**  
P.K.Thomas 5

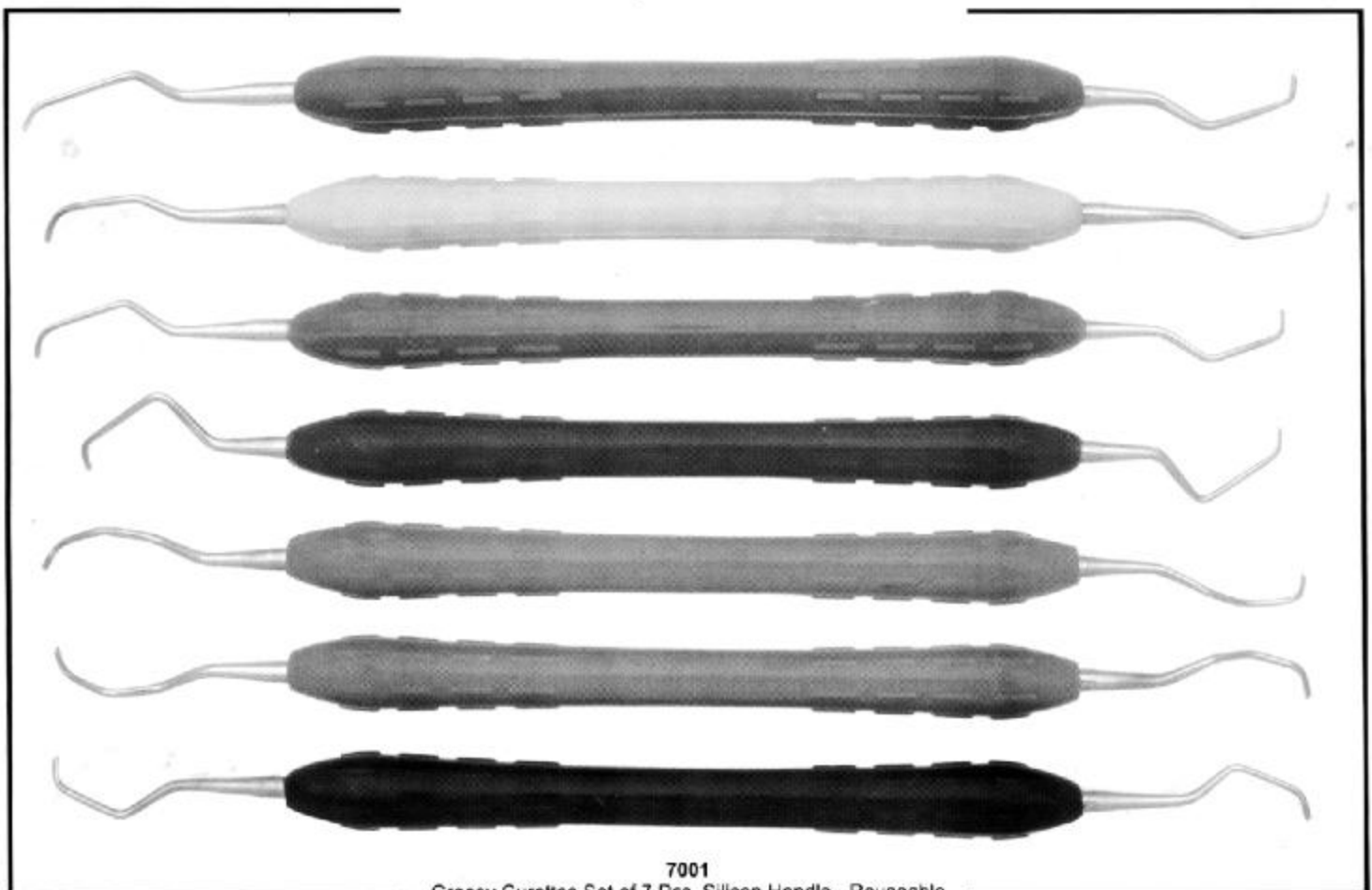

**7001**

Gracey Curettes Set of 7 Pcs, Silicon Handle - Reuseable

# AMALGAM PLUGGERS

## / CONDENSERS / APPLICATORS



**1830**  
BEHRMAN (Fig. 1)



**1831**  
BLACK (Fig. 1-2)



**1832**  
MORQUETTE (Fig. 0/1)



**1833**  
Black Action 11/12 Plugger



**1834**  
Hollenback No. 1 Plugger



**1835**  
Hollenback No. 2 Plugger

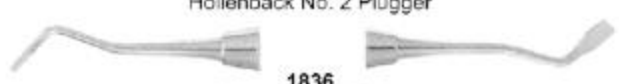

**1836**  
Hollenback No. 3 Plugger



**1837**  
Blacks 0-1 (1mm-1.5mm)



**1838**  
Blacks 1-2 (1.5mm-2.5mm)



**1839**  
Bodkin 1 (.7mm-1mm)



**1840**  
Bodkin 2 (1.5mm-2mm)

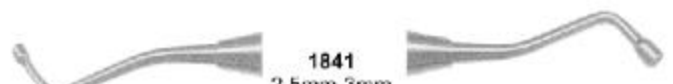

**1841**  
2.5mm-3mm



**1842**  
Oregon 2



**1843**  
.7mm-1mm



**1844**  
1mm-1.5mm



**1845**  
1.5mm-2mm



**1846**  
Oregon (Fig. 3)



**1847**  
Oregon (Fig. 4)



**1848**  
UP 12



**1849**  
Applicator 1-2



**1850**  
Birtles Applicator Spatula



**1851**  
Birtles Applicator Spatula K

# PLACEMENT INSTRUMENTS

## / STOPPING STOPPERS / PLUGGERS

### Placement Instruments

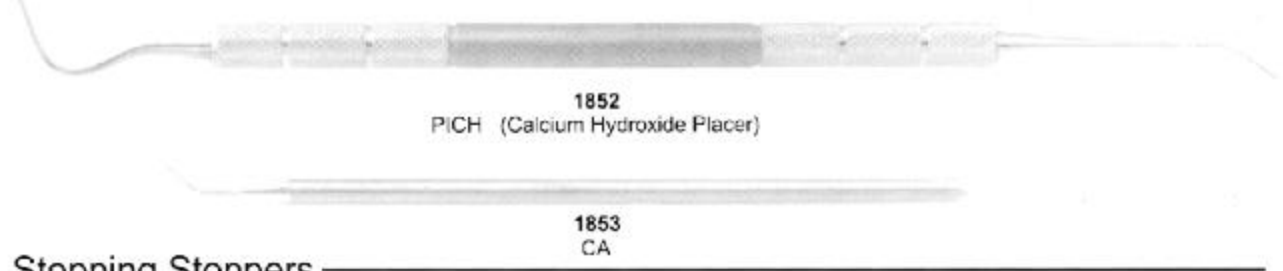

### Stopping Stoppers

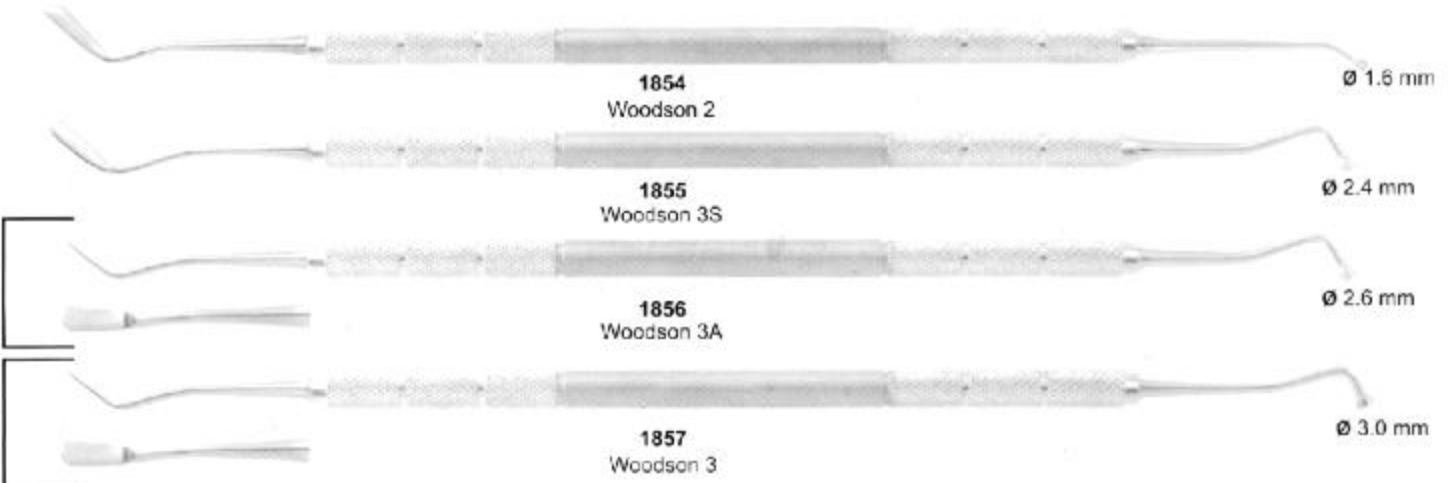

### Pluggers

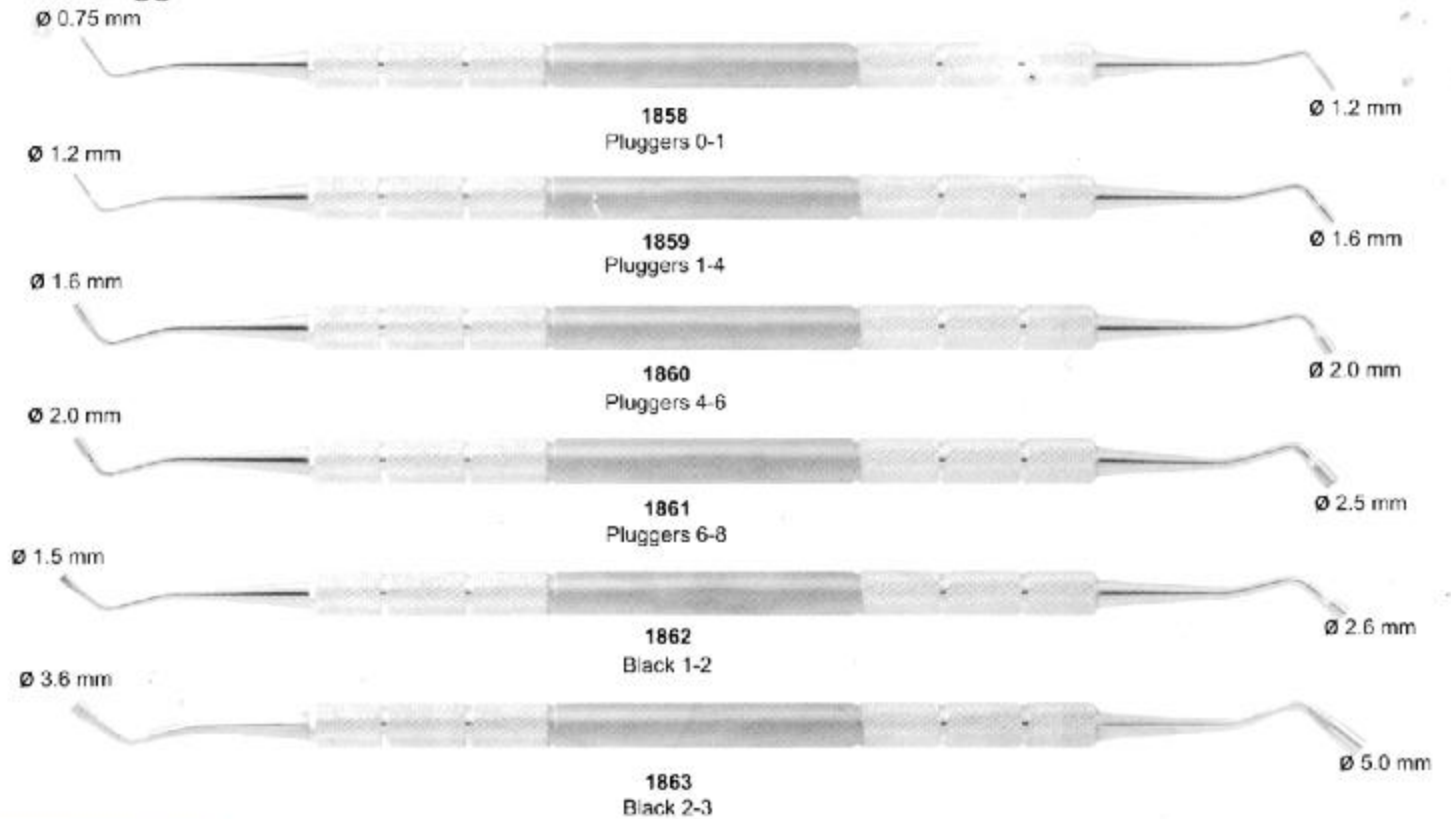

# BURNISHERS



1864  
Fig. 1



1865  
Fig. 28/29



1866  
Fig. 34



1867  
Fig. 27/29



1868  
Fig. 21B



1869  
ACORN  
Fig. 21

# BURNISHERS



**1870**  
21 Acorn



**1871**  
Fig. 21B



**1872**  
Fig. 2-34



**1873**  
Fig. 21C

**1874**  
Fig. 26-28



**1875**  
Fig. 2-30

**1876**  
Fig. 28-30



**1877**  
Fig. 27-29

**1878**  
PKT 1



**1879**  
Fig. 27-30

**1880**  
PKT 2



**1881**  
Fig. 34T

**1883**  
PKT 3



**1882**  
Fig. 3

**1885**  
PKT 3P



**1884**  
PFI 21

**1887**  
PKT 4



**1886**  
Pitts Pedo 19



**1888**  
Pitts Pedo 18

**1889**  
PKT 5





# WAX CARVERS

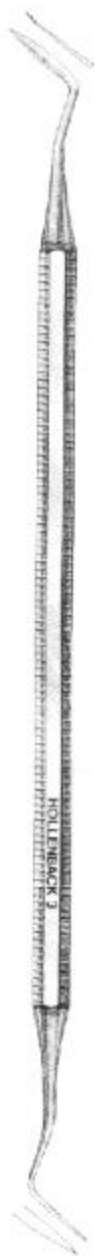

**1890**  
HOLLENBACK  
Fig. 3



**1891**  
HOLLENBACK  
Fig. 3S



**1892**  
WARD  
Fig. 1



**1893**  
WARD  
Fig. 2

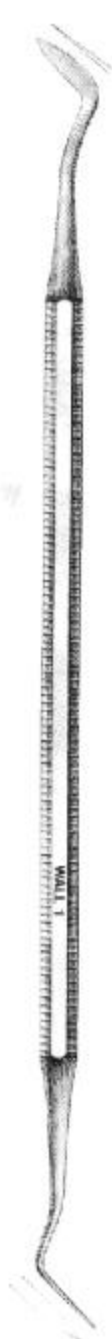

**1894**  
WALL  
Fig. 1



**1895**  
WALL  
Fig. 3



**1896**  
Fig. 3/6  
Cleoid/Discoïd



**1897**  
Fig. 89/92  
Cleoid/Discoïd

# CARVERS



**1898**  
1.5mm Cleoid Discoid (Shown with GTX Finish)



**1899**  
2mm Cleoid Discoid



**1900**  
GOLLOBIN  
Fig. 1



**1901**  
3mm Cleoid Discoid



**1902**  
HOLLENBACK  
Fig. 1/2



**1903**  
FRAHM  
Fig. 2-3 (off-angle)



**1904**  
HOLLENBACK  
Fig. 3



**1905**  
Interproximal 1



**1906**  
THOMPSON (Fig. 3)  
( $\frac{1}{2}$  Hollenback Hoe & Wall 3)



**1907**  
Interproximal 1



**1908**  
THOMPSON (Fig. 5)  
( $\frac{1}{2}$  Hollenback Hoe & Tanner 5)



**1909**  
Baum Interproximal



**1910**  
THOMPSON (Fig. 8)  
(3mm Cleoid & Wall 3)



**1911**  
Sho A Carver



**1912**  
THOMPSON (Fig. 9)  
(Hollenback 3 & Wall 3)



**1913**  
Thompson 2



**1914**  
WARD  
Fig. 2



# CARVERS / CHISELS



## Contour Carbide Carvers - Finishing

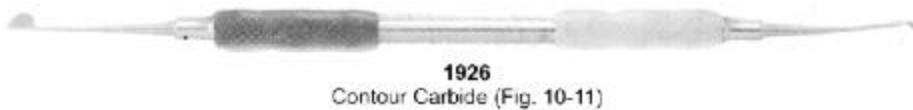
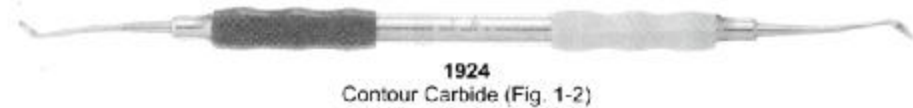

## Chisels



# COMPOSITE PLACEMENTS

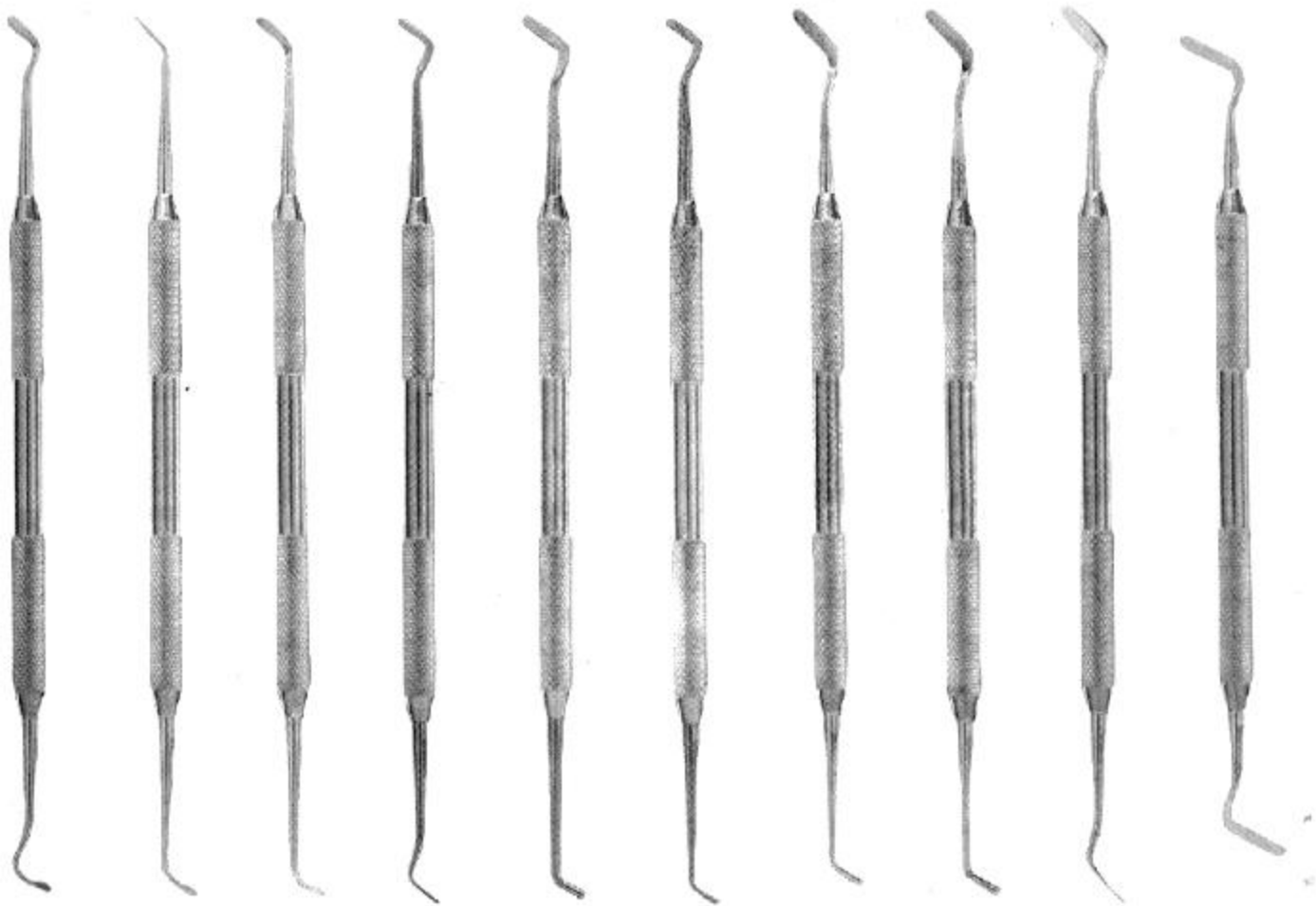

1932 F-Type 1    1933 F-Type 2    1934 F-Type 3    1935 F-Type 4    1936 F-Type 5    1937 F-Type 6    1938 G-Type 1    1939 G-Type 2    1940 G-Type 3    1941 G-Type 4

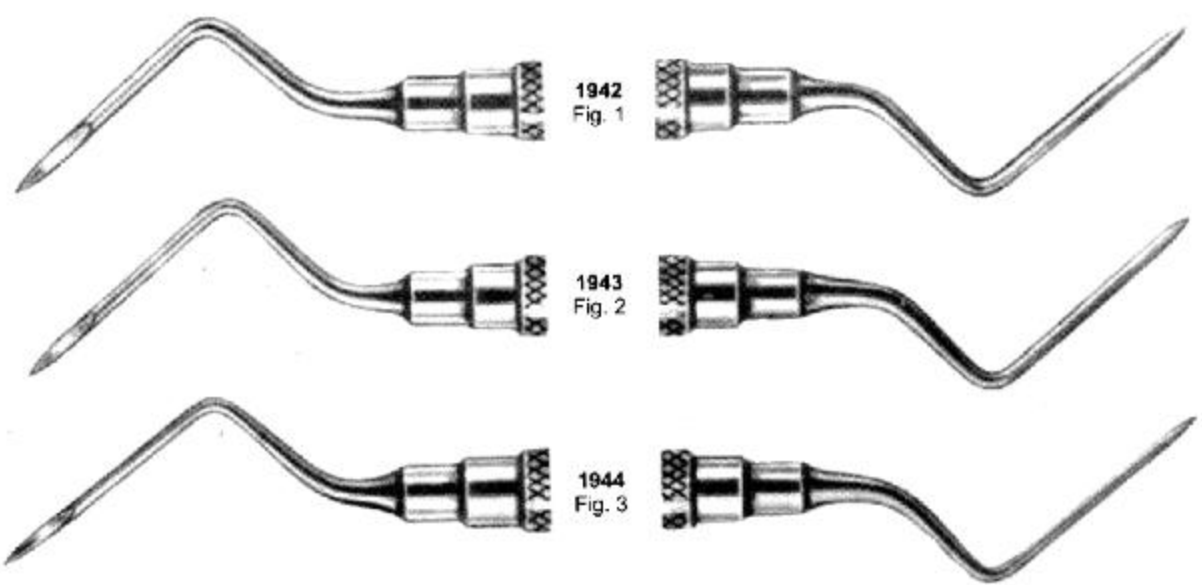

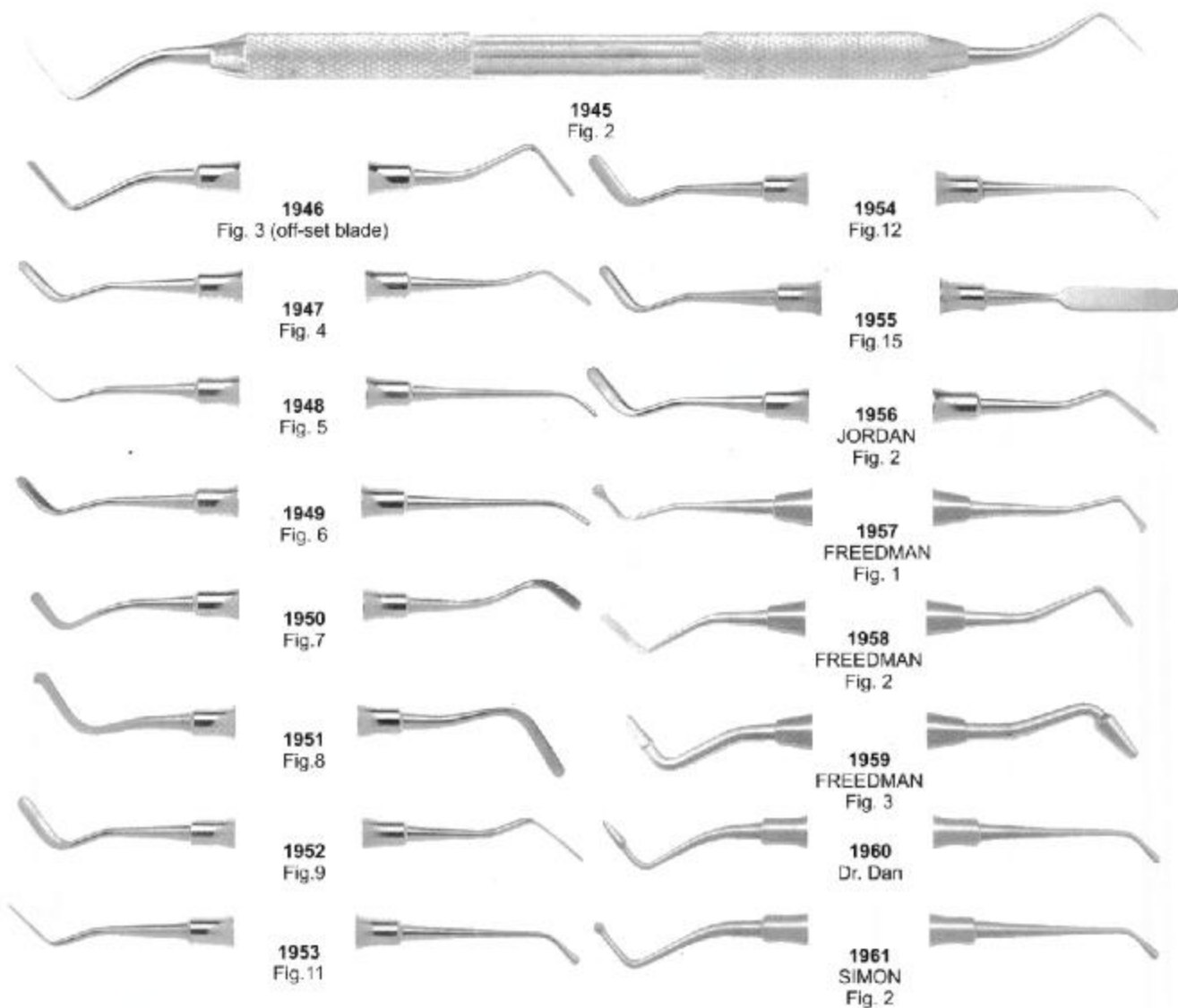

K - Type

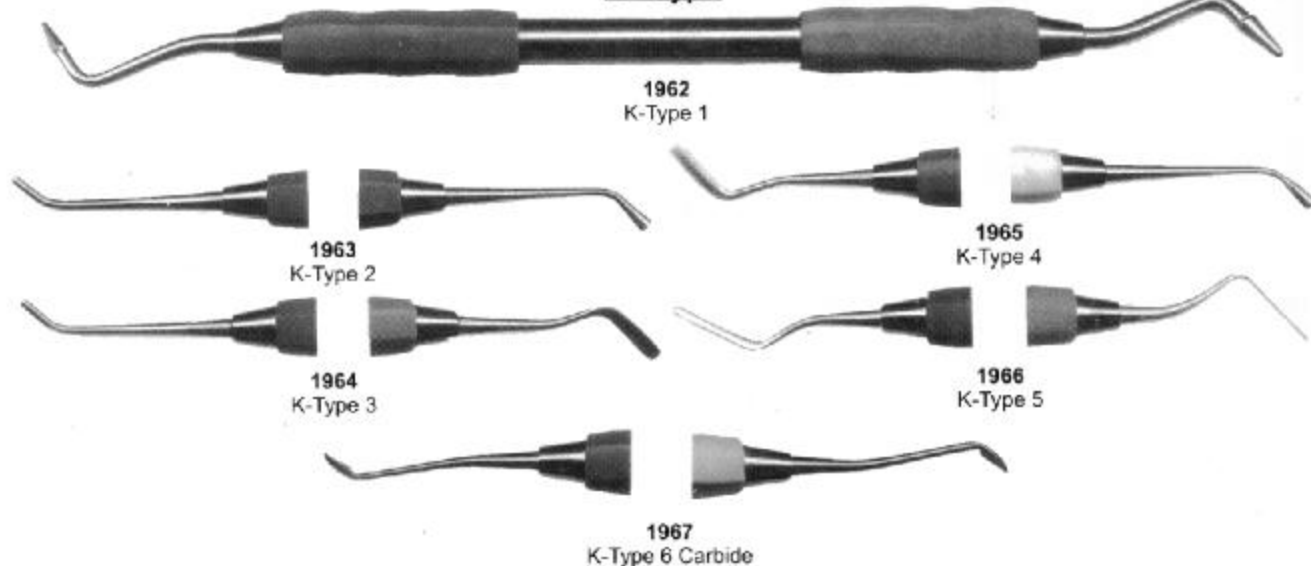

**PLASTIC FILLING INSTRUMENTS**



**1968** No.3  
**1969** No.4  
**1970** No.5  
**1971** LADMORE Fig. 3  
**1972** WOODSON Fig. 1  
**1973** WOODSON Fig. 2  
**1974** WOODSON Fig. 3  
**1975** W-3  
**1976** Gregg 4/5

**COMPOSITE PLACEMENTS**



**1977**  
Fig. 5-7



**1978**  
Fig.1



**1979**  
Fig. 3



**1983**  
GLICK  
Fig.1



**1980**  
Fig. 4



**1984**  
P8



**1981**  
Fig. 5-7



**1985**  
WOODSON  
Fig. 1



**1982**  
Fig. 8A



**1986**  
WOODSON  
Fig. 2



**1987**  
WOODSON  
Fig. 3

## CURETTES



**1988**  
GRACEY  
GC 1-2



**1989**  
GRACEY  
GC 3-4



**1990**  
GRACEY  
GC 5-8



**1991**  
GRACEY  
GC 7-8

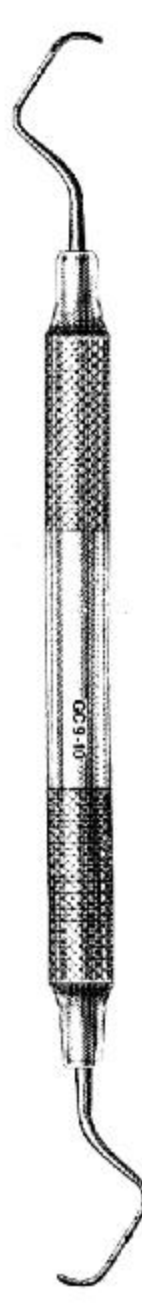

**1992**  
GRACEY  
GC 9-10



**1993**  
GRACEY  
GC 11-12



**1994**  
GRACEY  
GC 13-14



# GRACEY CURETTES



1995  
G1-2



1996  
G3-4

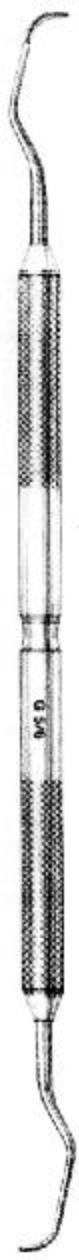

1997  
G5-6



1998  
G7-8



1999  
G9-10



2000  
G11-12



2001  
G13-14

ART # 2000A

**COMPOSITE INSTRUMENTS (SET OF 6)**



Composite Instrument  
JULL-DENT 401



Composite Instrument  
JULL-DENT 402



Composite Instrument  
JULL-DENT 403



Composite Instrument  
JULL-DENT 404



Composite Instrument  
JULL-DENT 405



Composite Instrument  
JULL-DENT 406

# GRACEY SET

ART # 2000B

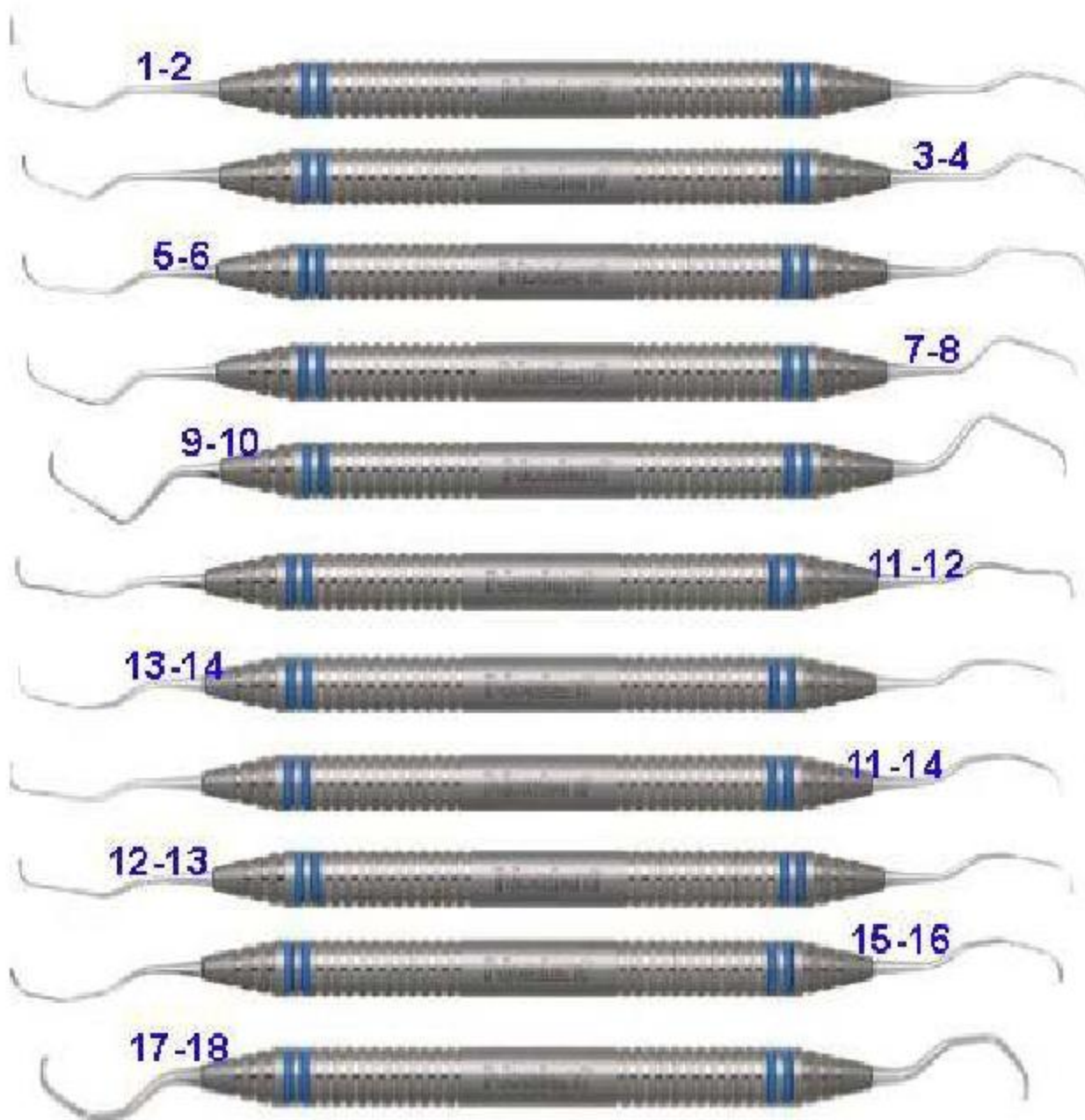

# GRACEY CURETTES

## ART # 2000C

Gracey Curettes color coded handle Ø 8 mm



## ART # 2000D



## CURETTES # 4 HANDLES

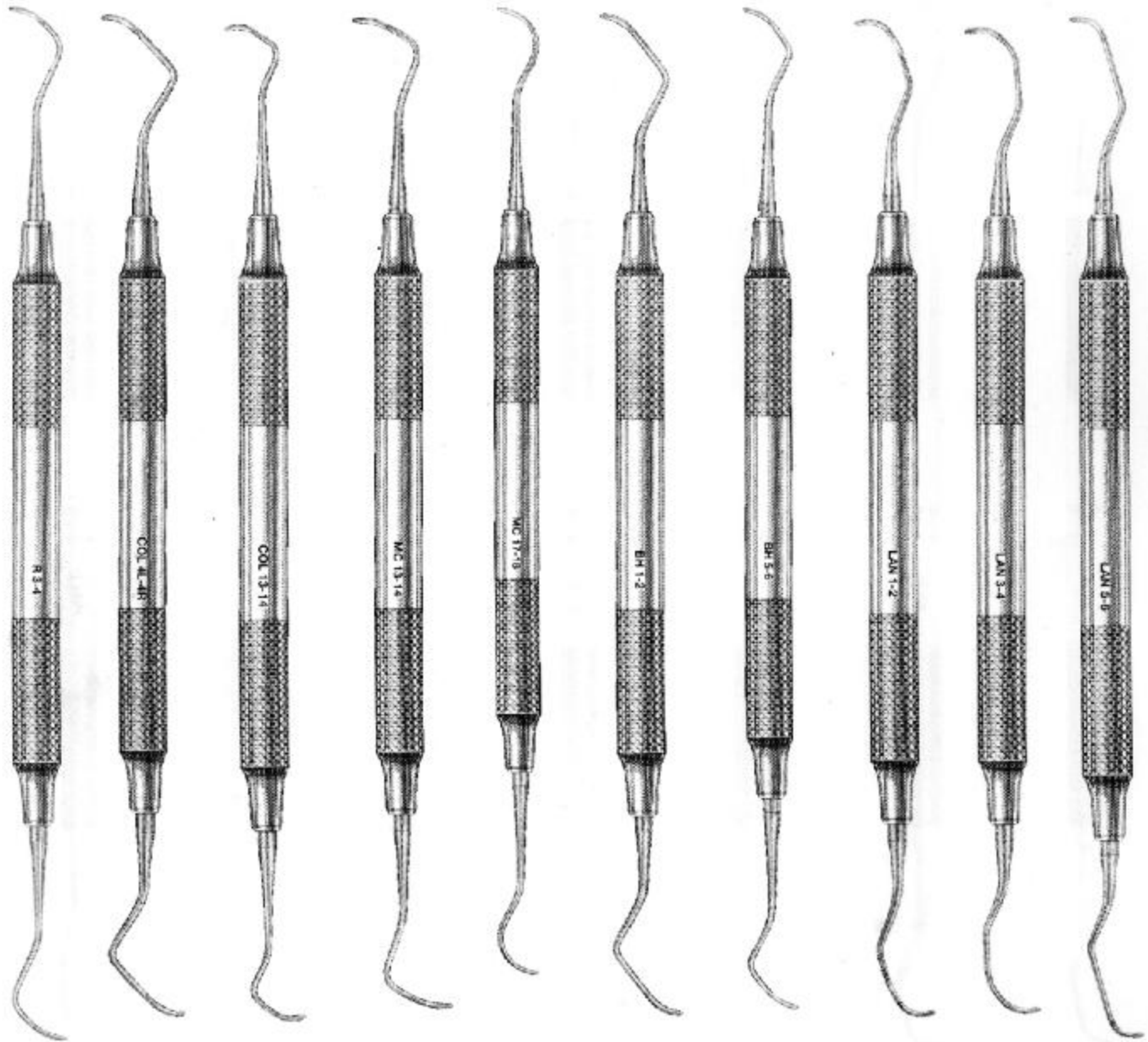

2002  
RULE  
3-4

2003  
COLUMBIA  
4R-4L

2004  
COLUMBIA  
13-14

2005  
MCCALLS  
13-14

2006  
MCCALLS  
17-18

2007  
BARNHART  
1-2

2008  
BARNHART  
5-6

2009  
LANGER  
1-2

2010  
LANGER  
3-4

2011  
LANGER  
5-6

# CURETTES

## COLUMBIA CURETTES



2012  
4L-4R

2013  
13-14

2014  
2L-2R

## MCCALLS CURETTES

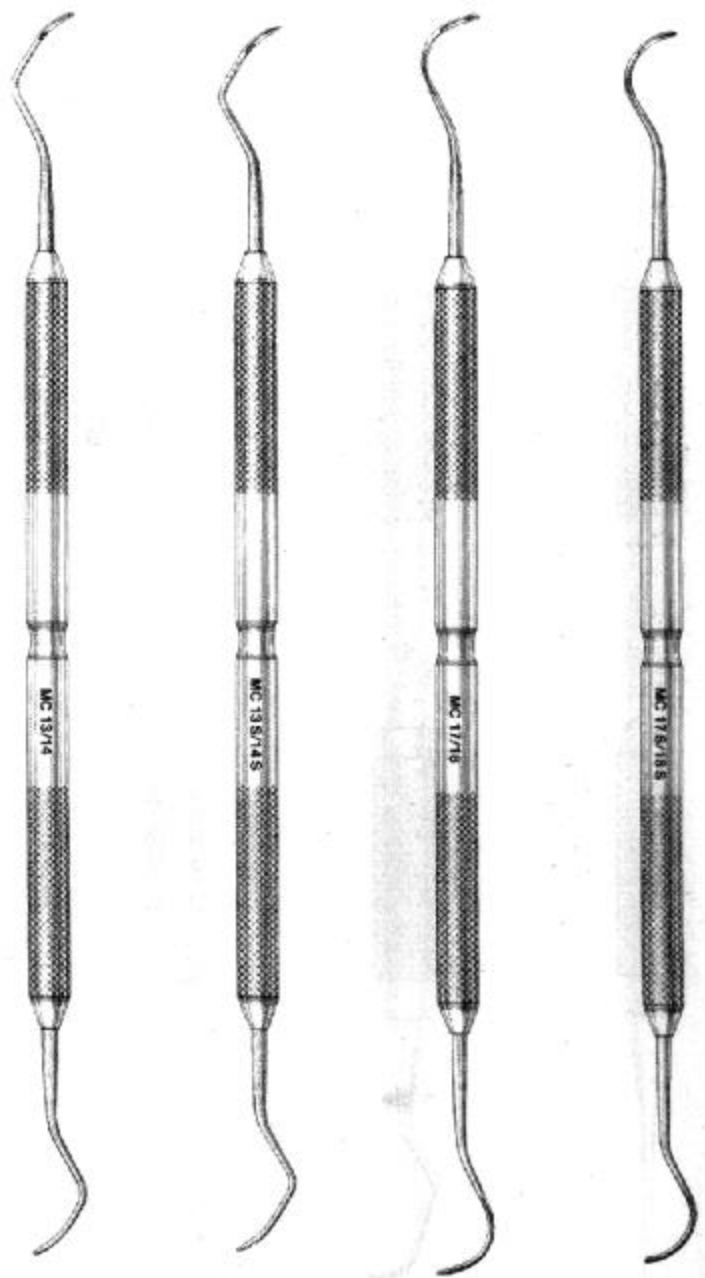

2015  
13-14

2016  
13S-14S

2017  
17-18

2018  
17S-18S

# CURETTES

## GOLDMAN FOX



**2019**  
GF1 Universal Scaler



**2020**  
GF2 Curette



**2021**  
GF3 Curette



**2022**  
GF4 Curette



**2023**  
GF5 Hoe

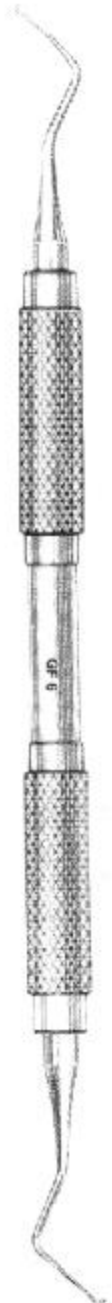

**2024**  
GF6 Hoe

# CURETTES

## GOLDMAN FOX



**2025**  
GF 7 Knife



**2026**  
GF 8 Spear Knife



**2027**  
GF 9 Knife Scaler



**2028**  
GF 11 Spear Knife



**2029**  
GF 21 Sharp Spoon /  
Small Scaler



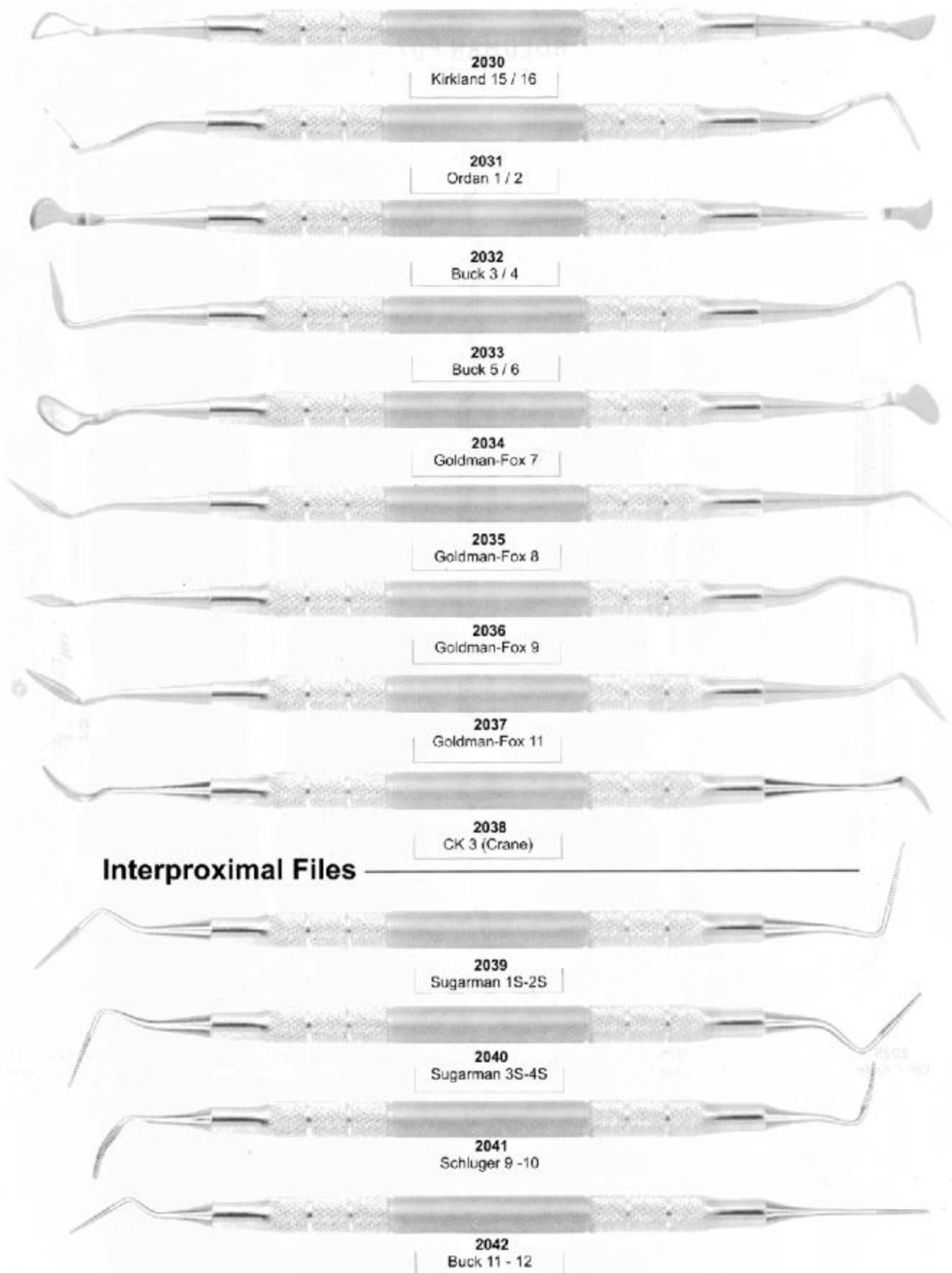

# CURETTES

## / ROOT PLANNING CURETTES



2043  
COLUMBIA (2L-2R)



2044  
MCCALL (13-14)



2045  
MCCALL (17S-18S)

### Root Planning Curettes



2046  
Root Plane (1-2)



2047  
Root Plane (5-6)



2049  
Root Plane (11-12)



2048  
Root Plane (7-8)



2050  
Root Plane (13-14)



2051  
Petite (1-2)



2052  
Petite (11-12)



2053  
Petite (5-6)



2054  
Petite (13-14)

# CURETTES



2055  
BARNHART (1-2)



2056  
BARNHART (5-6)

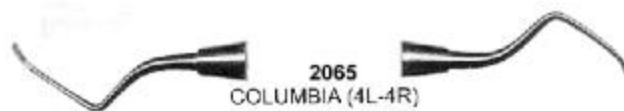

2065  
COLUMBIA (4L-4R)



2057  
GRACEY (1-2)

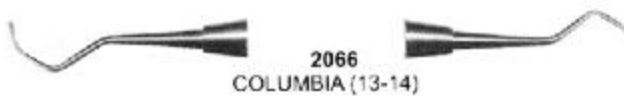

2066  
COLUMBIA (13-14)



2058  
GRACEY (3-4)



2067  
LANGER (1-2)

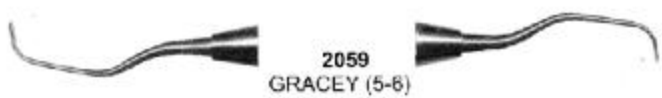

2059  
GRACEY (5-6)

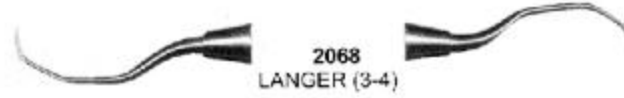

2068  
LANGER (3-4)



2060  
GRACEY (7-8)



2069  
LANGER (5-6)



2061  
GRACEY (9-10)

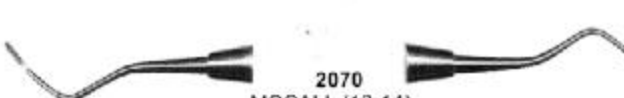

2070  
MCCALL (13-14)



2062  
GRACEY (11-12)

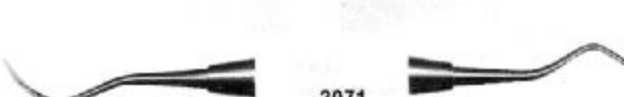

2071  
MCCALL (13S-14S)



2063  
GRACEY (13-14)

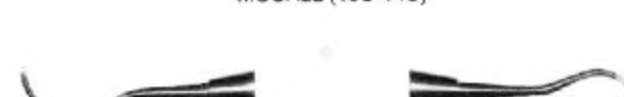

2072  
MCCALL (17-18)

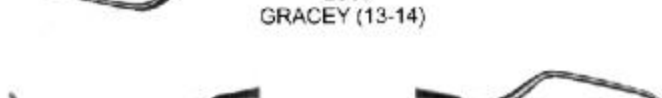

2064  
GRACEY (2L-2R)

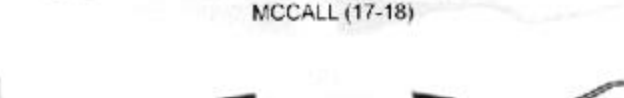

2073  
MCCALL (17S-18S)



2074  
RULE (3-4)

# DENTAL PRODUCTS

Silicon Handles-Reusable

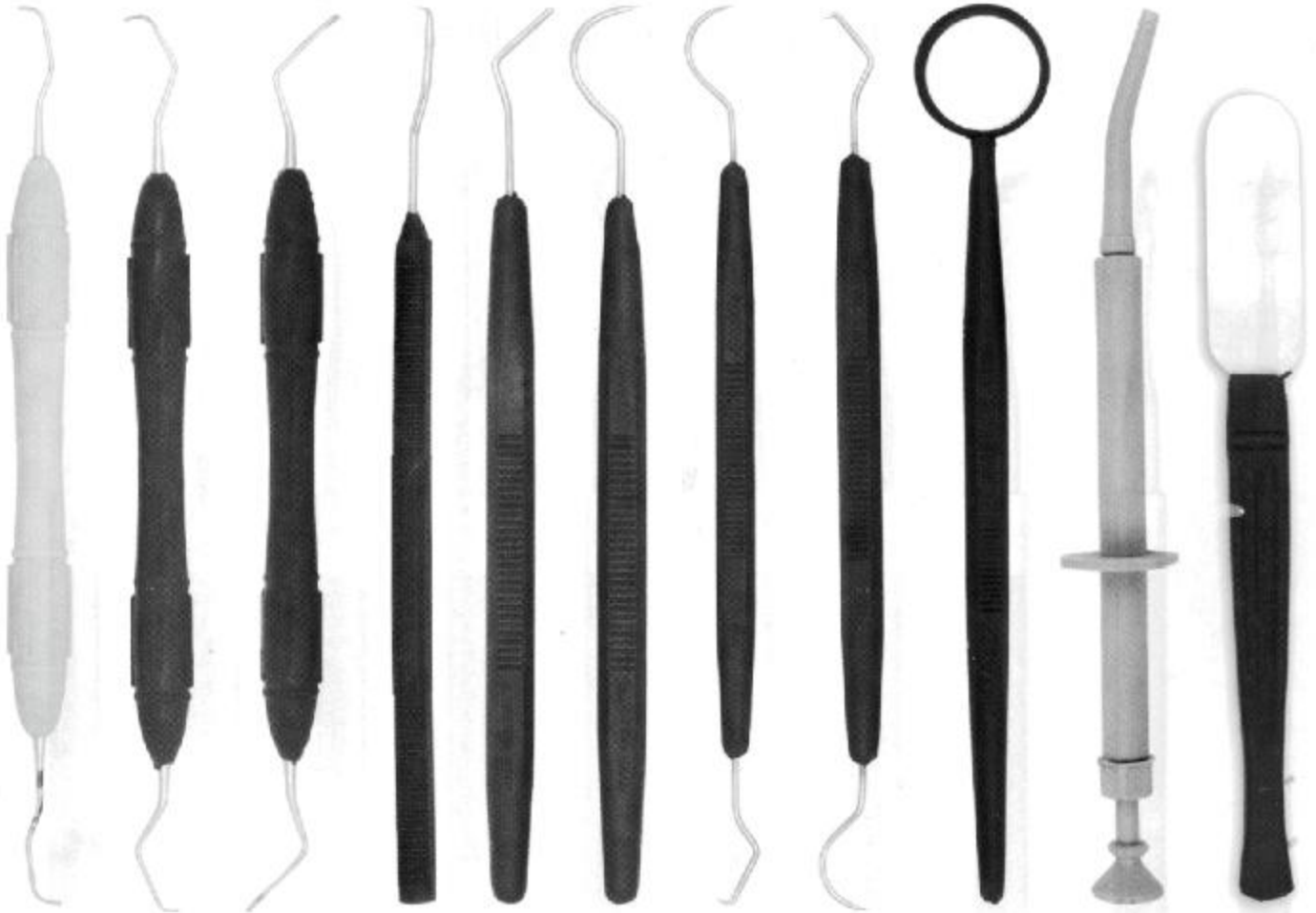

2075

2076

2077

2078

2079

2080

2081

2082

2083

2084

2085



2086



2087



2088



2089



2090

# WAX PORCELAIN

## & CEMENT INSTRUMENTS

### Comfort Grip Vinyl - Covered Insulating Handles



# WAX PORCELAIN

## & CEMENT INSTRUMENTS

### P.K. THOMAS

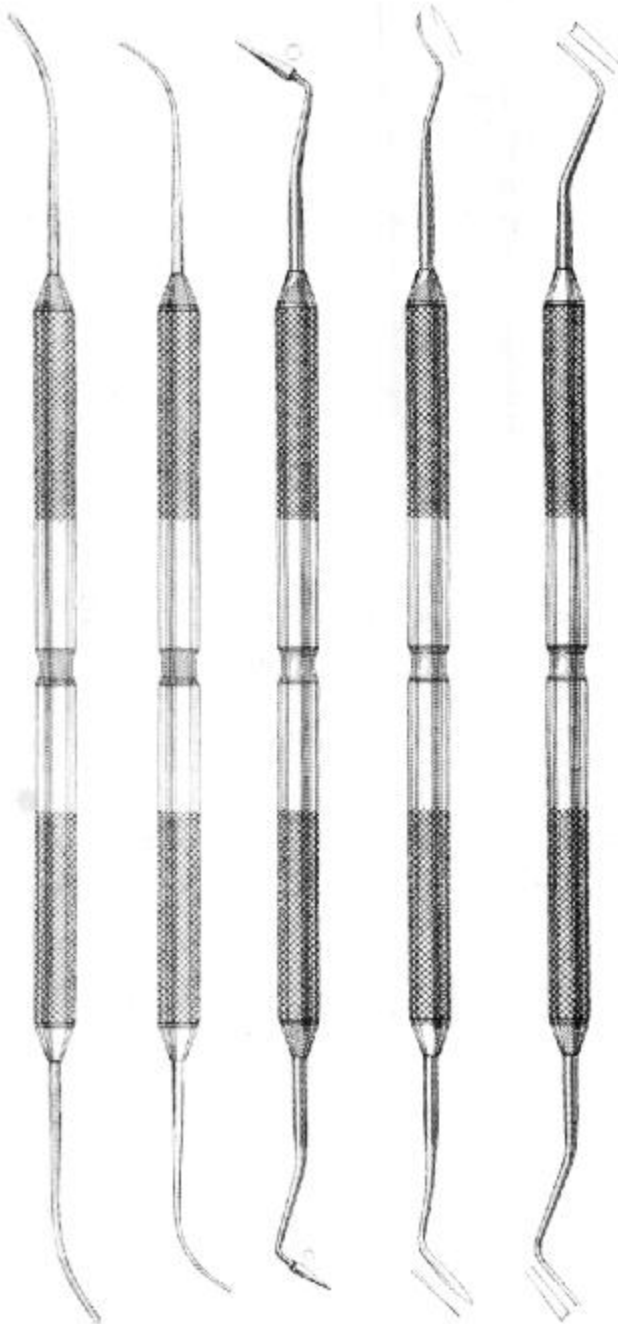

2101 PKT 1    2102 PKT 2    2103 PKT 3    2104 PKT 4    2105 PKT 5

Set of 5 instruments

### WAX CARVERS

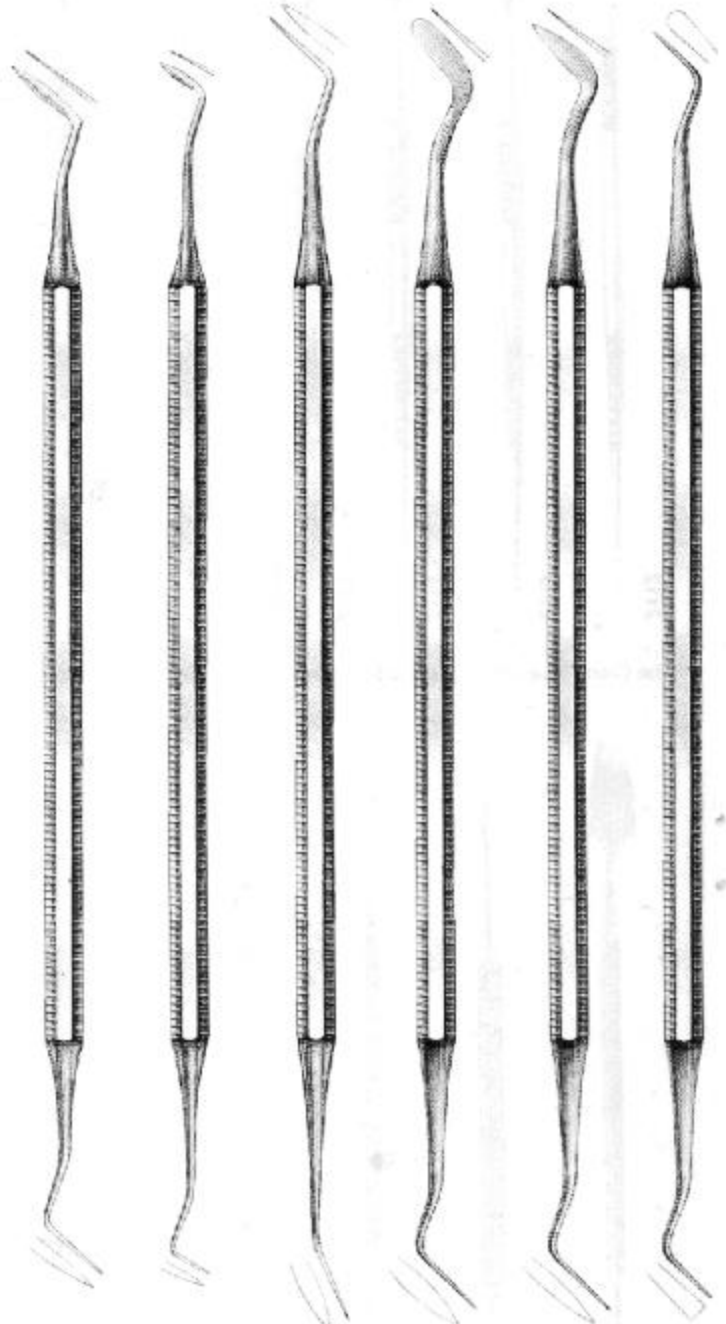

2106 Hollenback 3    2107 Hollenback 3S    2108 WARD 1    2109 WARD 2    2110 WALL 1    2111 WALL 3

**WAX & MODELING CARVERS**

**/ CEMENT SPATULAS**

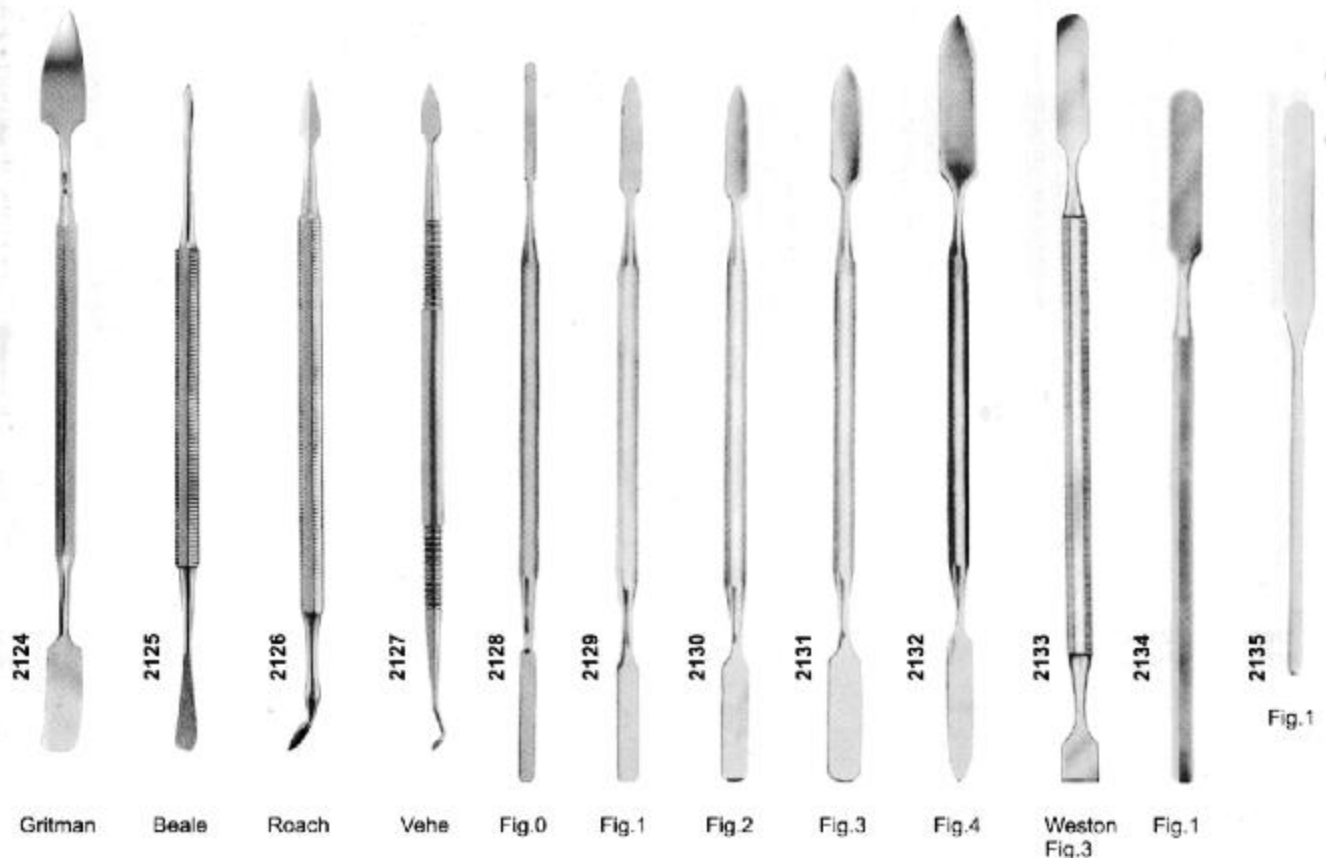
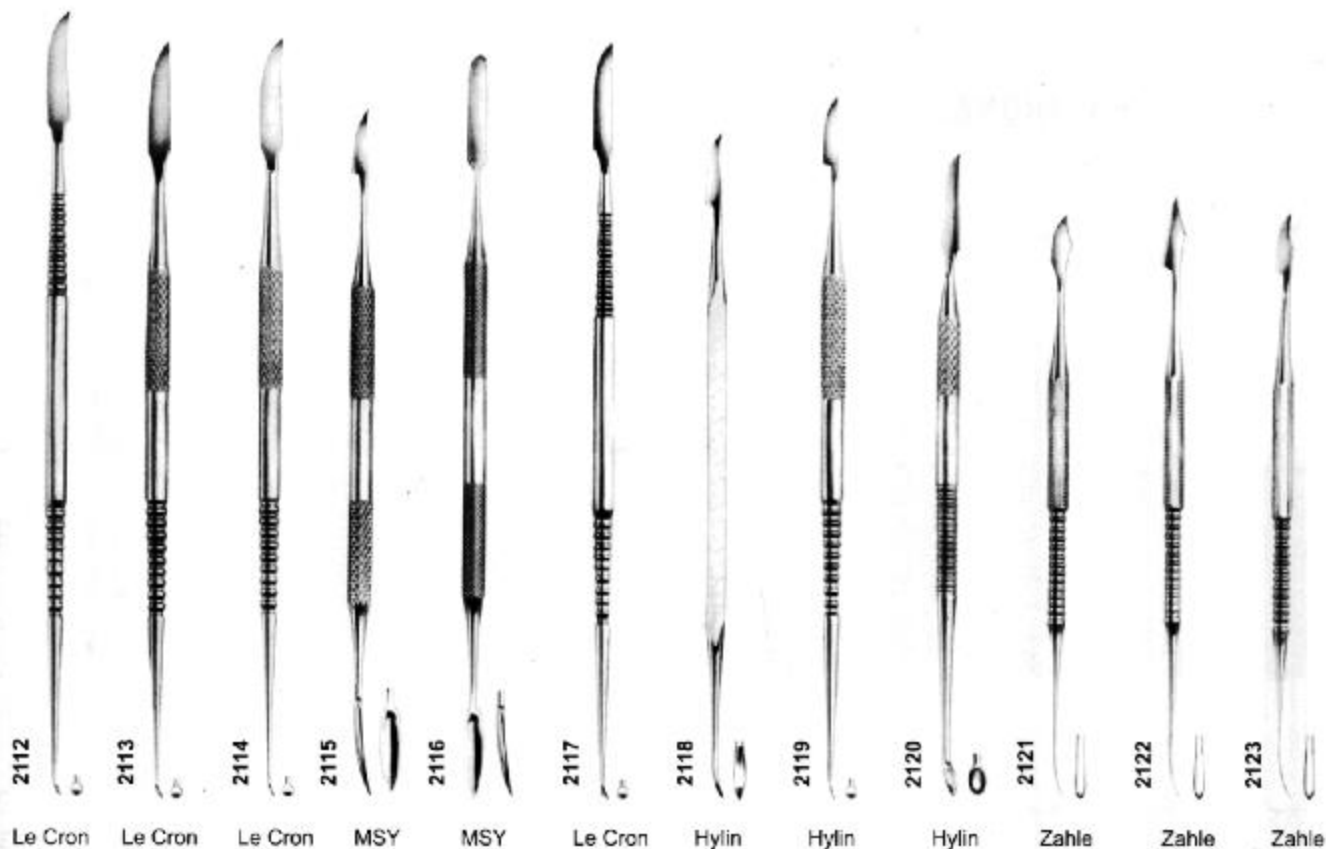

# WAX PORCELAIN

## & CEMENT INSTRUMENTS

### WAX & PORCELAIN CARVERS

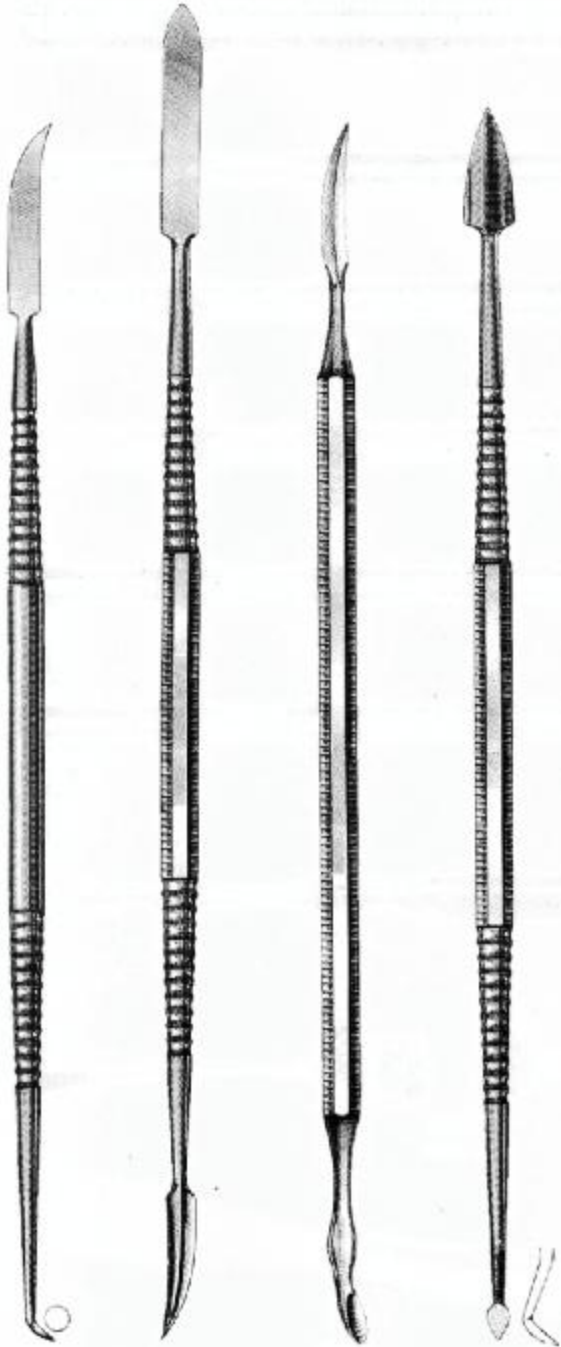

2136  
LECRON  
Inlay

2137  
REEVES

2138  
VEHE  
Wax

2139  
ROACH  
Wax

### WAX SPATULAS

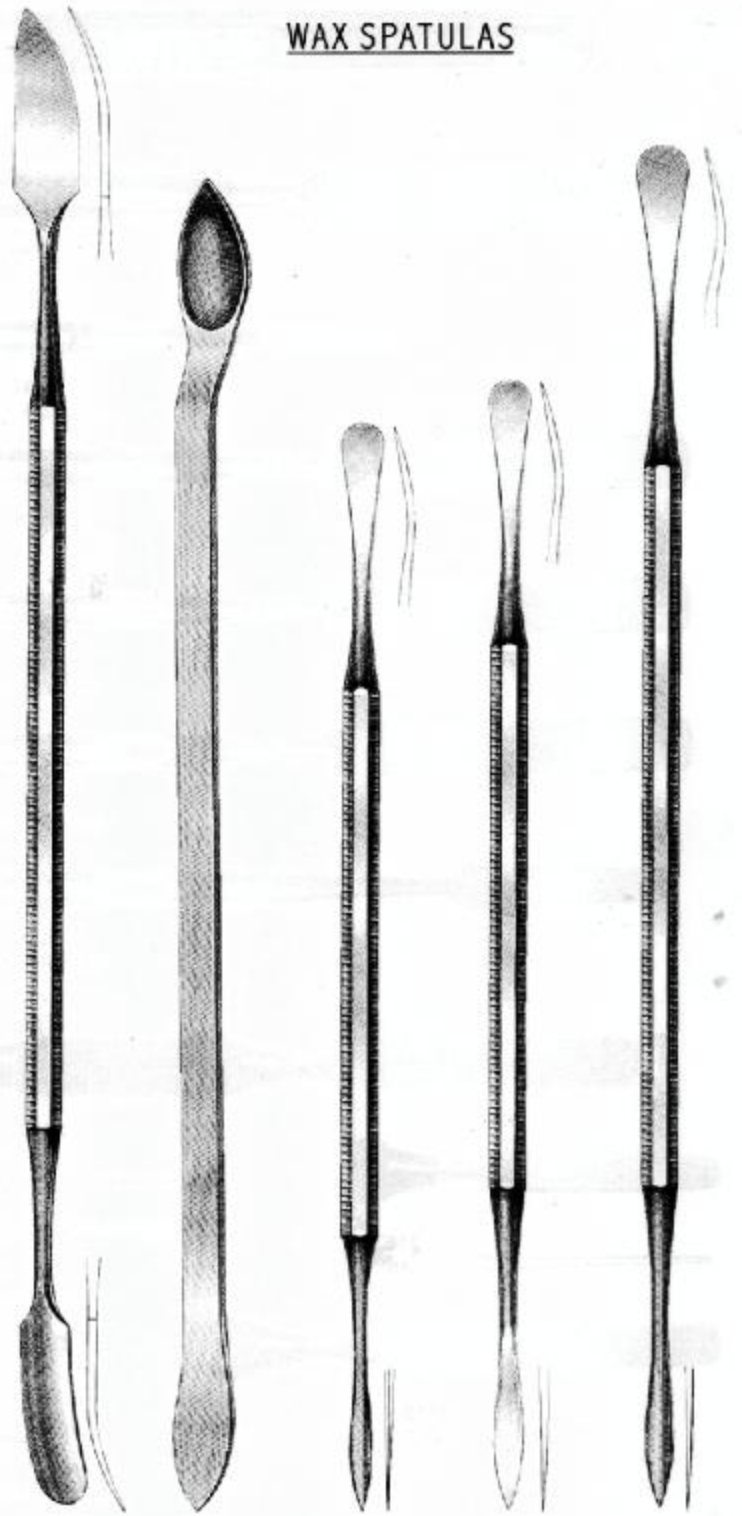

2140  
W-31

2141  
W-5

2142  
W-7

2143  
W-7A

2144  
W-7G



# CEMENT SPATULAS



2145  
AGATHE



2146  
C-7



2147  
C-5

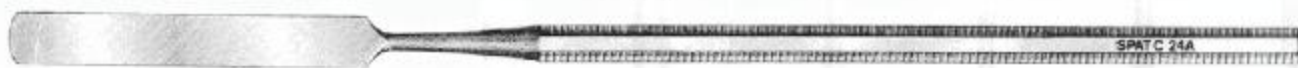

2148  
C-313



2149  
C-24A Rigid

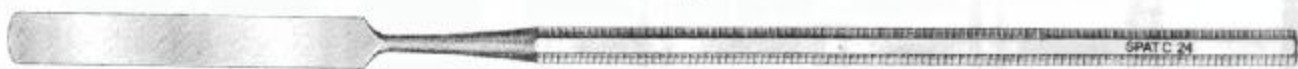

2150  
C-24 Flexible



2151  
C-24 Flexible



2152  
24



2153  
A6



2154  
7 Wax



2155  
26



2156  
All Metal Spatulas with High Polish  
Stainless Steel Blade



2157  
31

# SPATULAS

Rigid



**2158**  
Fig. 1  
18.5 cm



**2159**  
Fig. 2  
18 cm



**2160**  
Fig. 3  
18.5 cm



**2161**  
Fig. 4  
19.5 cm



**2162**  
Fig. 5  
21.5 cm



**2163**  
Fig. 6  
20.5 cm

Flexible

# SPATULAS

Rigid

Flexible

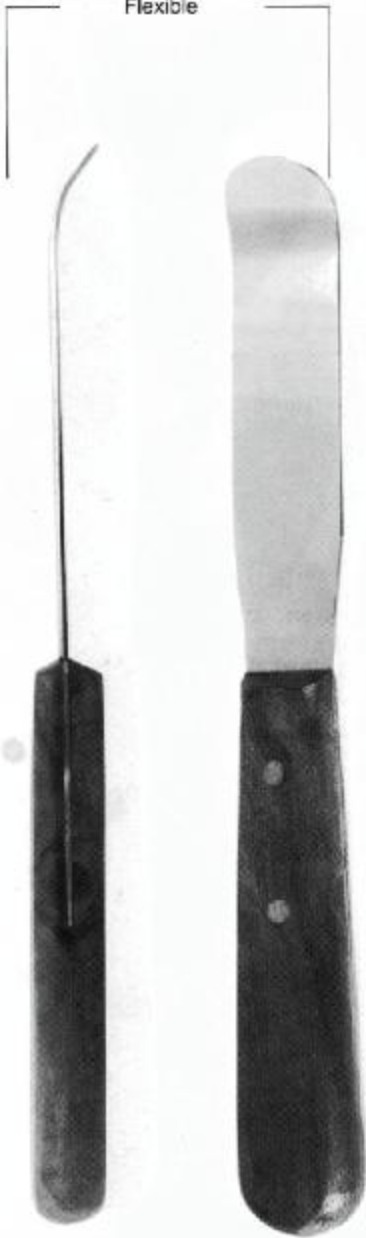

2164  
Fig. 7  
19.5 cm



2165  
Fig. 8  
20 cm

2166  
Fig. 9  
22.5 cm

**FILES**

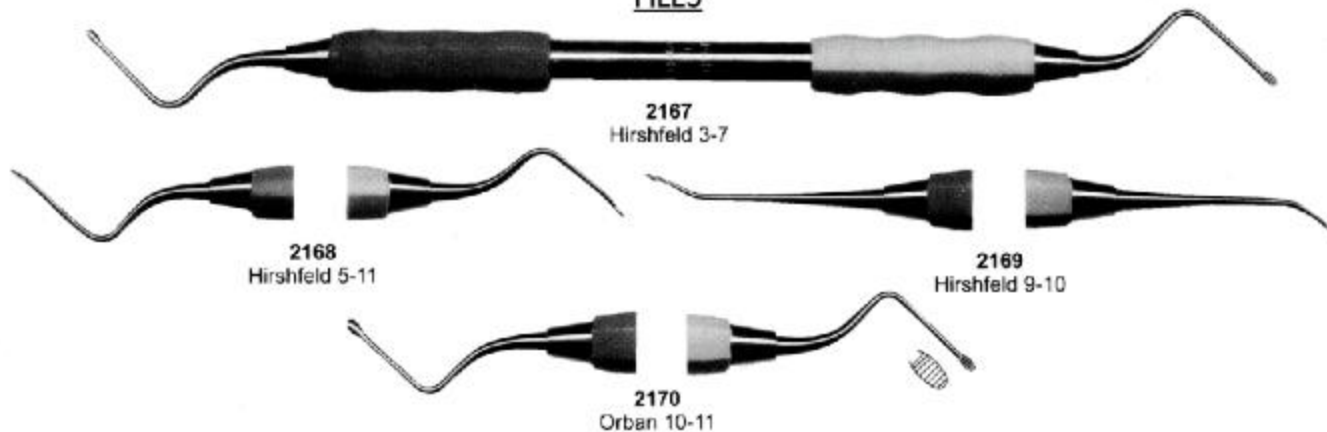

**HOES**

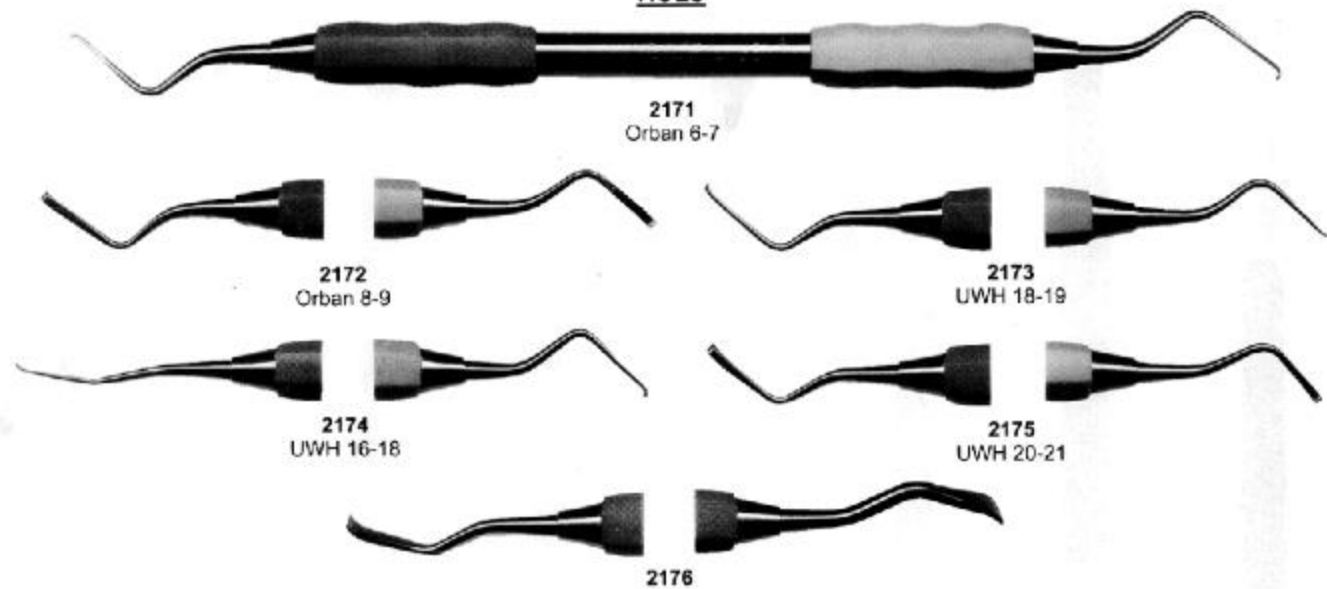

**KNIVES**

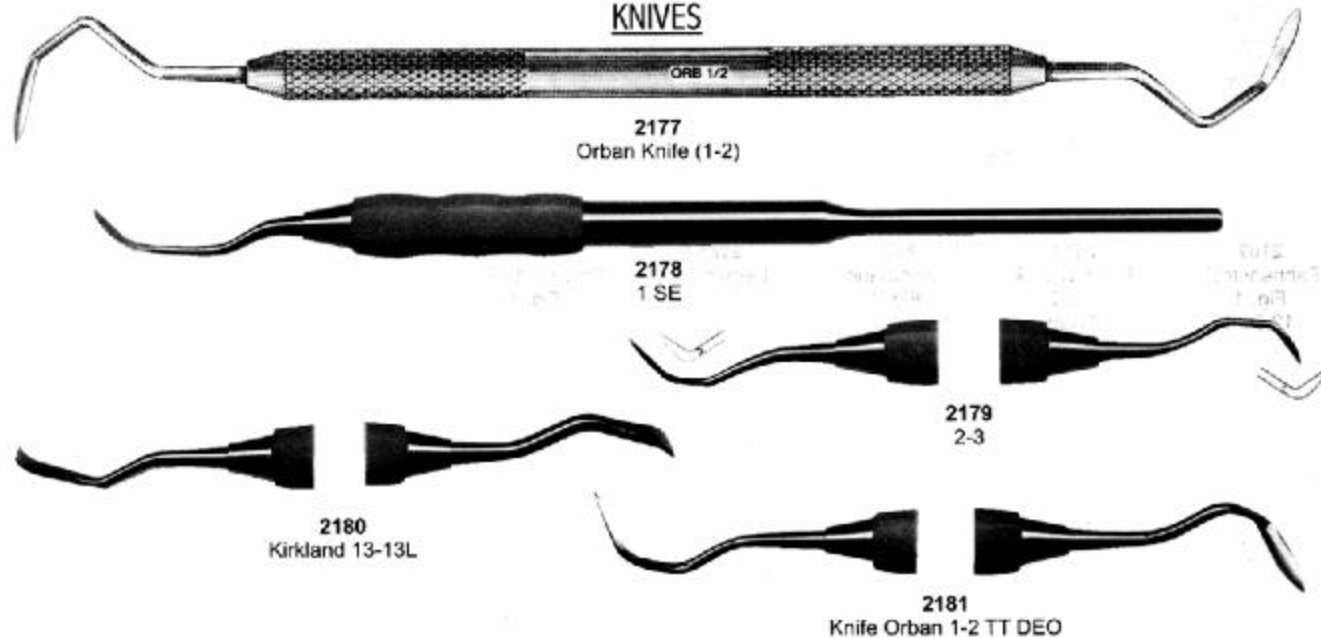

## WAX KNIVES



**2182**  
Fahnenstock  
Fig. 1  
12,5cm

**2183**  
Fahnenstock  
Fig. 2  
17cm

**2184**  
Lessmann  
Fig. 1  
12,5cm

**2185**  
Lessmann  
Fig. 2  
17cm

**2186**  
Con scodellino  
Fig. 1  
12,5cm

**2187**  
Con scodellino  
Fig. 2  
17cm

**2188**  
Ermert

**2189**  
Ermert

## WAX KNIVES

### & PLASTER KNIVES



**2190**  
18 cm  
7 1/8"



**2191**  
18 cm  
7 1/8"



**2192**  
17 cm  
6 3/4"  
Gritman



**2193**  
17 cm  
6 3/4"  
Medkon



**2194**  
Fig. 1  
17 cm



**2195**  
22 cm  
8 3/4"



**2196**  
22 cm  
8 3/4"



**2197**  
Gritman  
Fig. 2  
17 cm



**2198**  
Fig. 3  
16 cm



**2199**  
Fig. 4  
16 cm

# CRANE-KAPLAN

## / CHISELS

### CRANE-KAPLAN

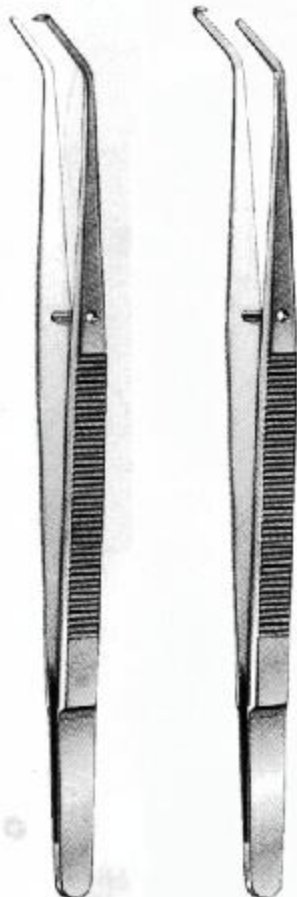

**2200**  
Ck1  
Pocket Marker

**2201**  
Ck2  
Pocket Marker



**2202**  
Knife



**2203**  
Dissector



**2204**  
Scaler

### OCHSENBEIN



**2205**  
Ochsenbein  
Fig. 1



**2206**  
Ochsenbein  
Fig. 2



**2207**  
Ochsenbein  
Fig. 4

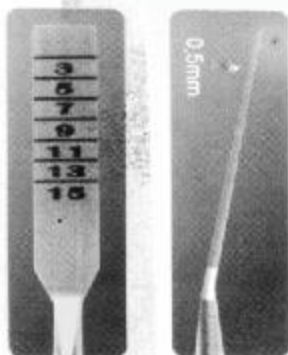

Split Chisel Set



**2208**  
Split Chisel  
6 mm Curved



**2209**  
Split Chisel  
6 mm Straight



**2210**  
Split Chisel  
4 mm Curved



**2211**  
Split Chisel

# BONE CURETTES



**2212**  
No. 1



**2213**  
No. 2



**2214**  
No. 4



**2215**  
No. 5L



**2216**  
No. 6R



**2217**  
No. 75



**2218**  
No. 2/4



**2219-A**  
Miller  
11 cm

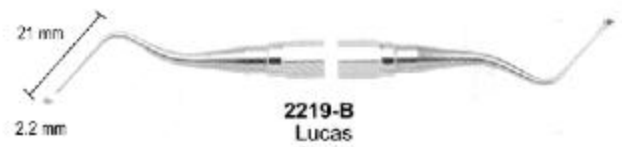

**2219-B**  
Lucas  
CL 84



**2219-C**  
Lucas  
CL 85

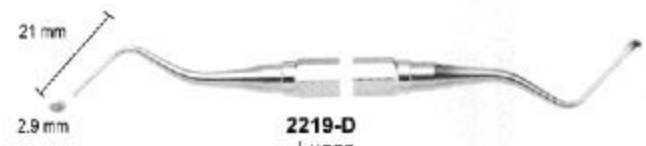

**2219-D**  
Lucas  
CL 86



**2219-E**  
Lucas  
CL 87



**2219-F**  
Lucas  
CL 88

**100% actual size**

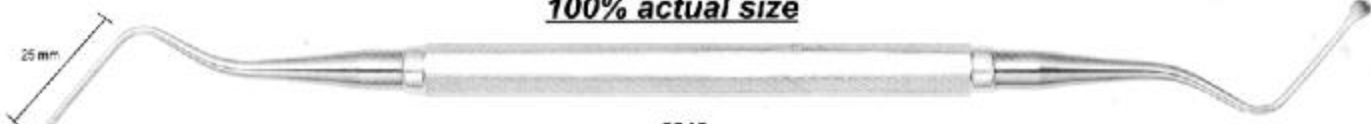

**2219**  
Miller  
10 cm



# BONE FILES

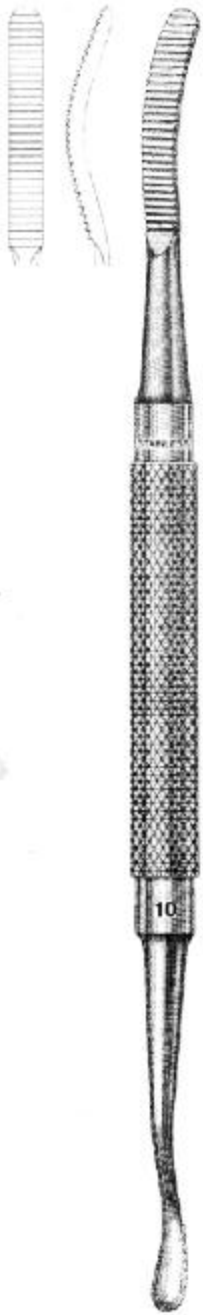

**2220**  
No. 10

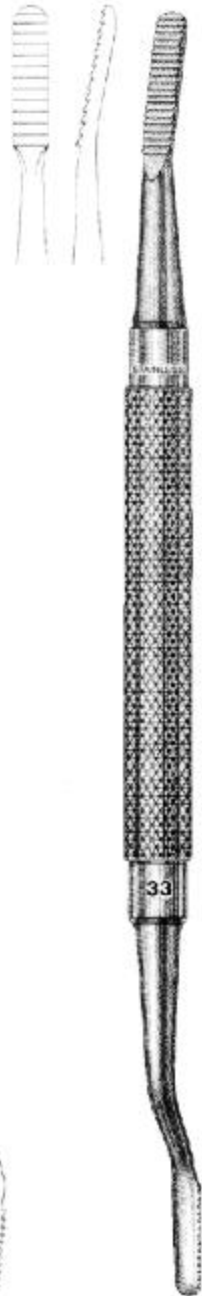

**2221**  
No. 33

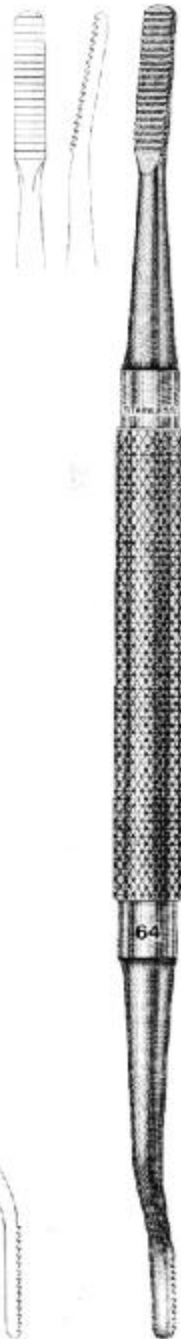

**2222**  
MILLER  
No. 33



**2223**  
MILLER  
No. 64

# BONE FILES

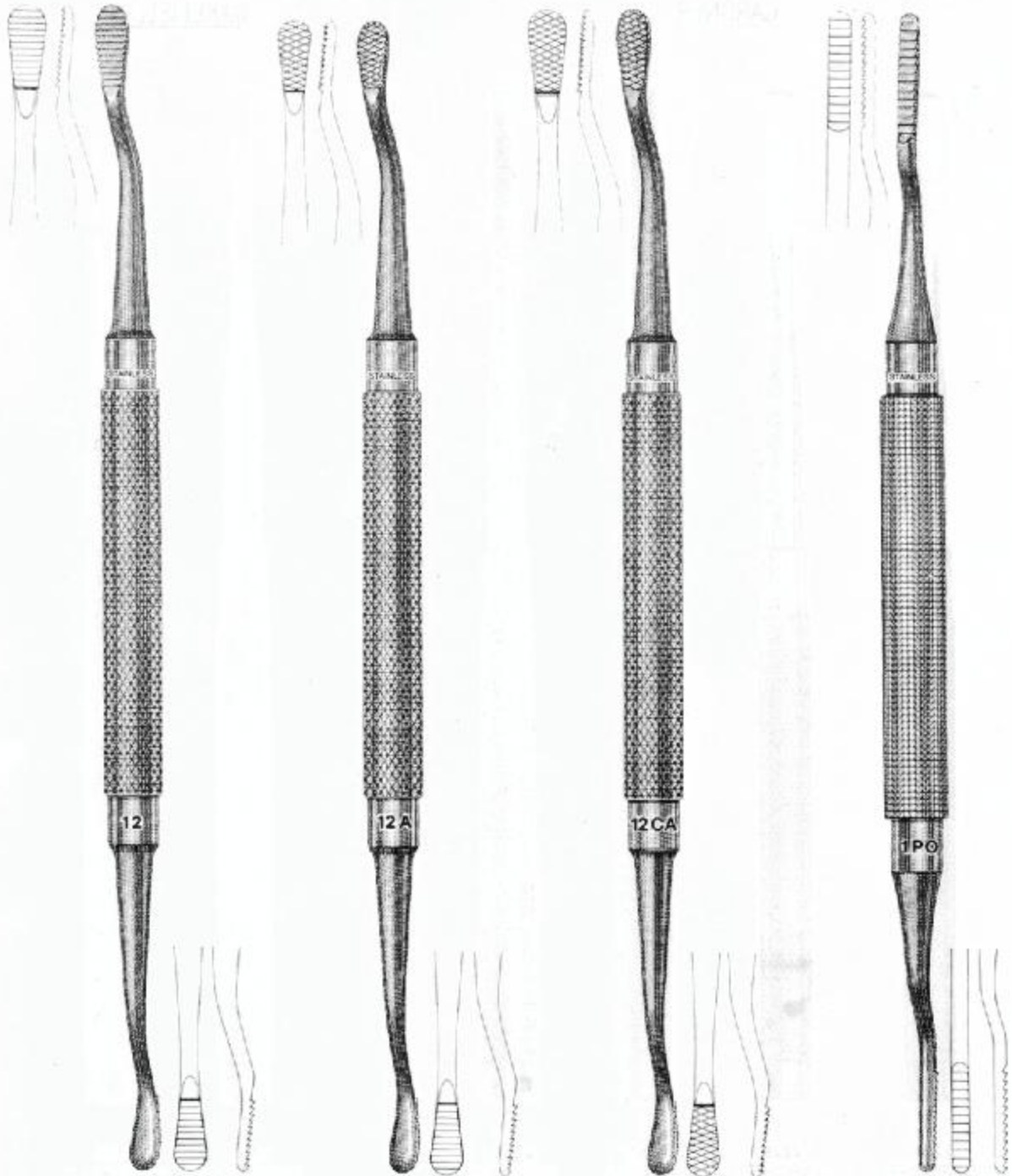

**2224**  
HOWARD  
No. 12

**2225**  
HOWARD  
No. 12A

**2226**  
HOWARD  
No. 12CA

**2227**  
POLOKOFF  
No. 1

# BONE CHISELS

## GARDNER

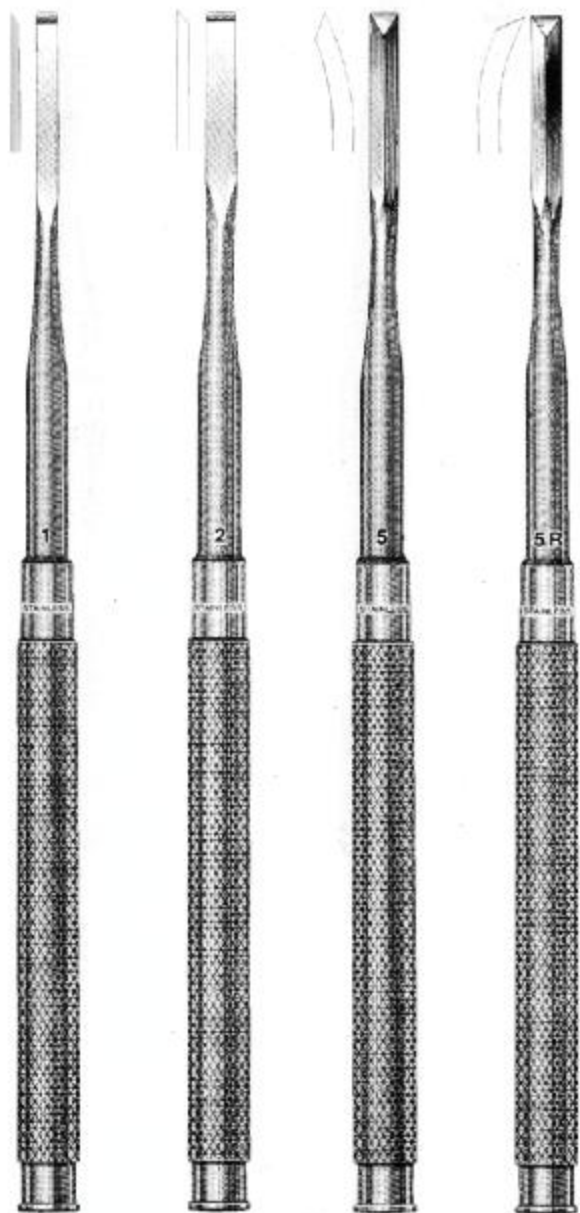

**2228**  
GARDNER  
No. 1

**2229**  
GARDNER  
No. 2

**2230**  
GARDNER  
No. 5

**2231**  
GARDNER  
No. 5R

## WAKEFIELD

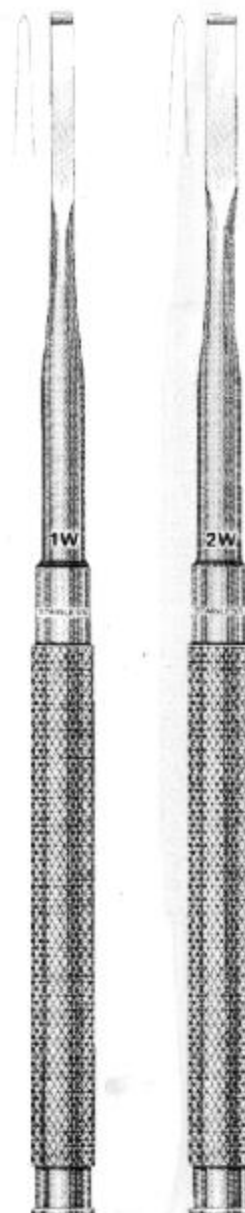

**2232**  
WAKEFIELD  
No. 1W

**2233**  
WAKEFIELD  
No. 2W

# BONE CHISELS

## / BONE MALLETS

### Bone Chisels and Gouges

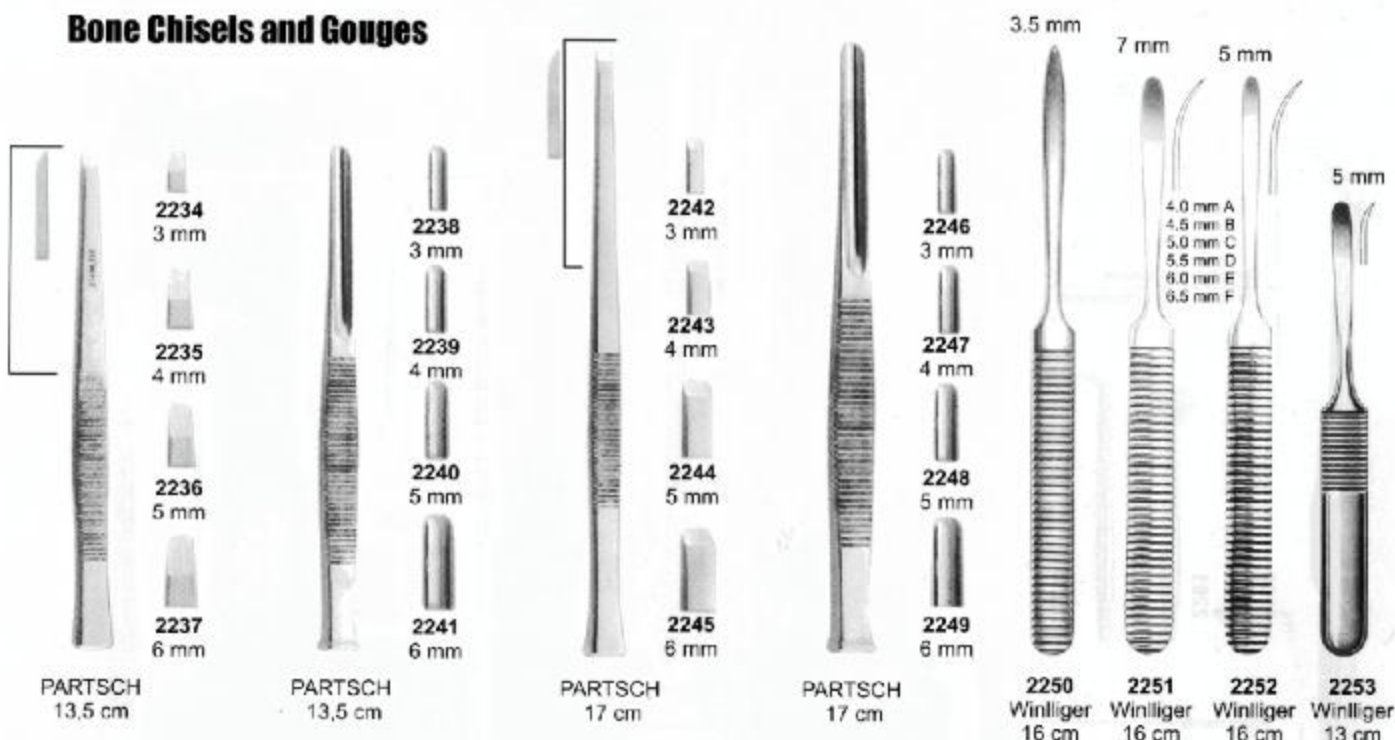

### Martelli chirurgici Mallet

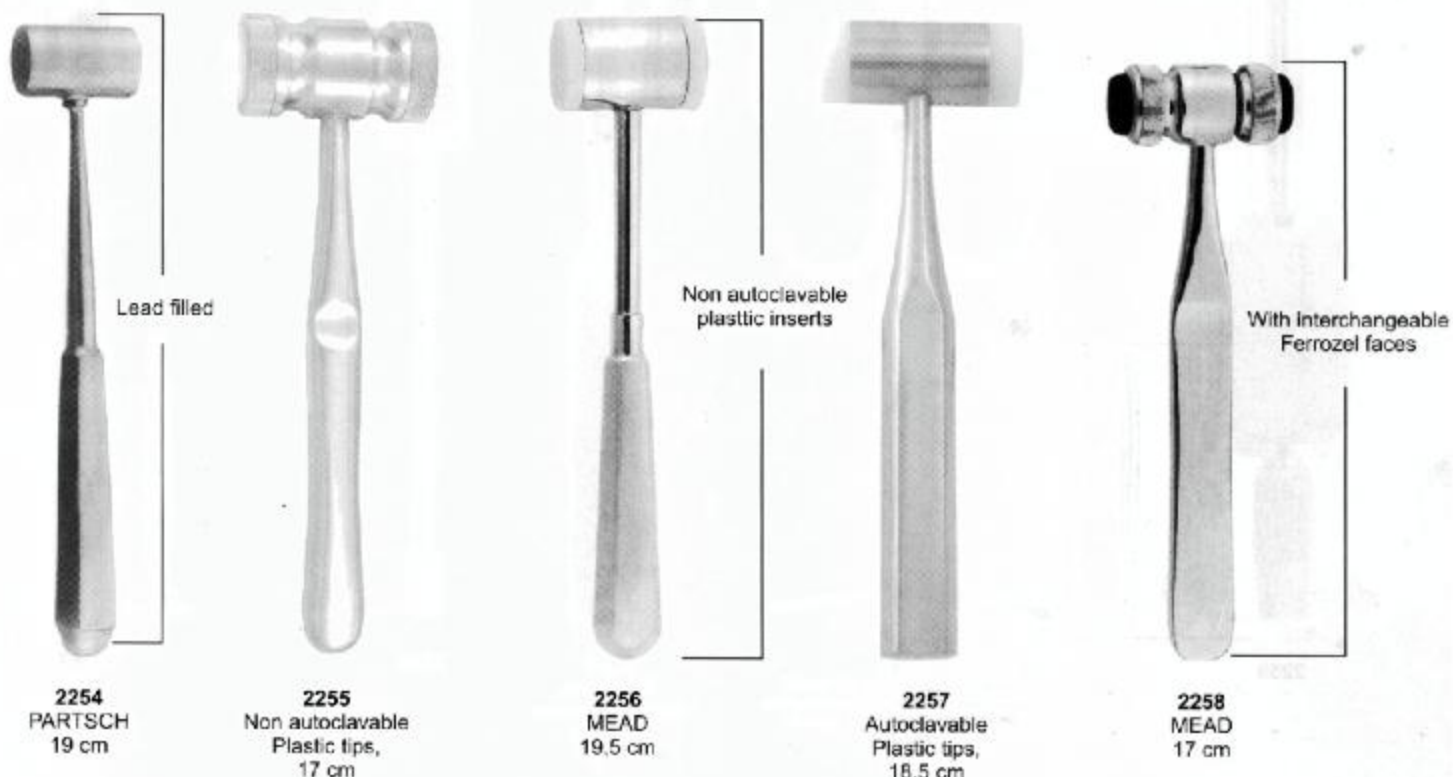

# CROWN REMOVERS

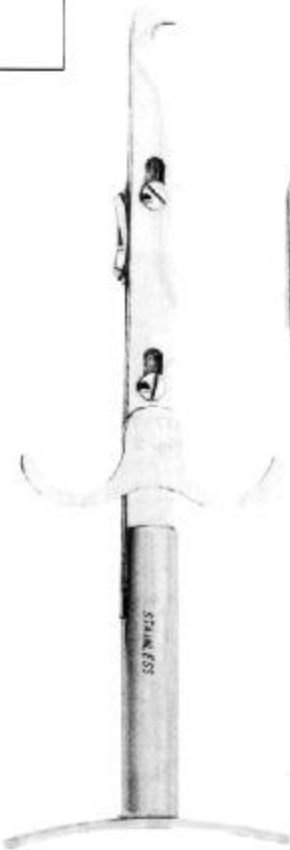
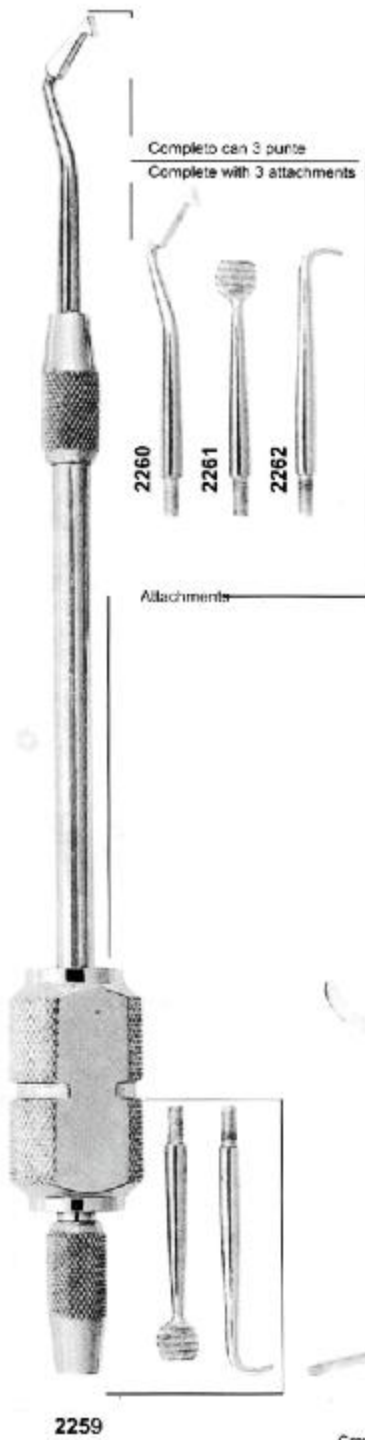

**2263**  
Crown Spreader, Crown Remove.  
Special instrument for crown spreading  
after separating, simple and safe  
operation.



**2264**  
Traymann,  
Crown Remover  
17.0 cm

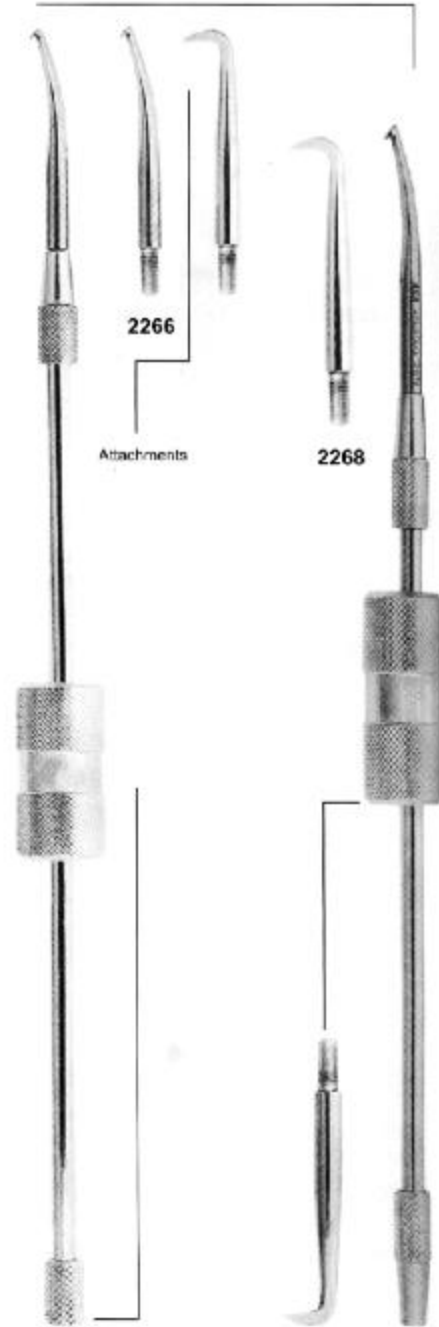

**2266**

**2267**

# BONE INSTRUMENTS

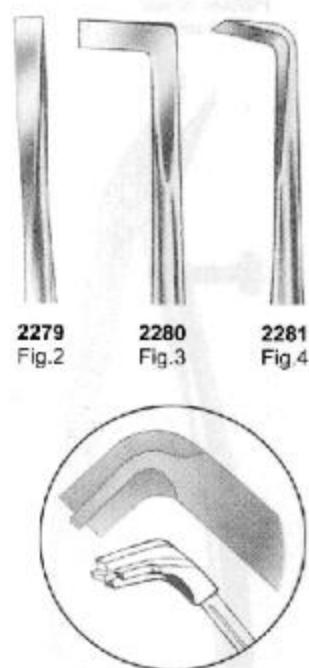
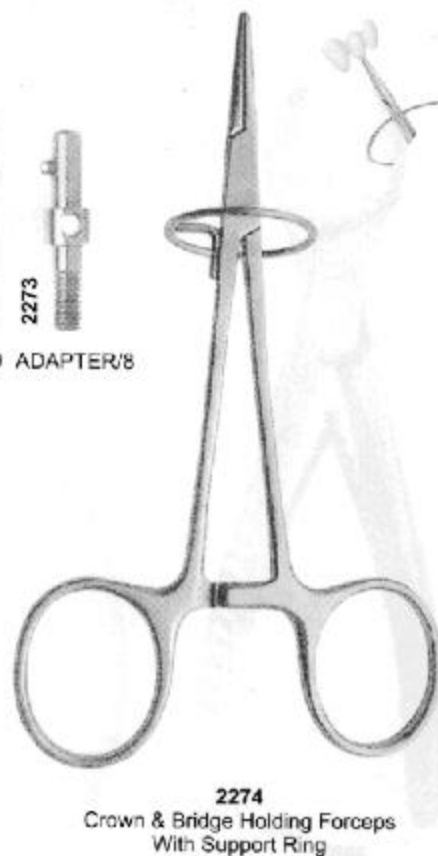
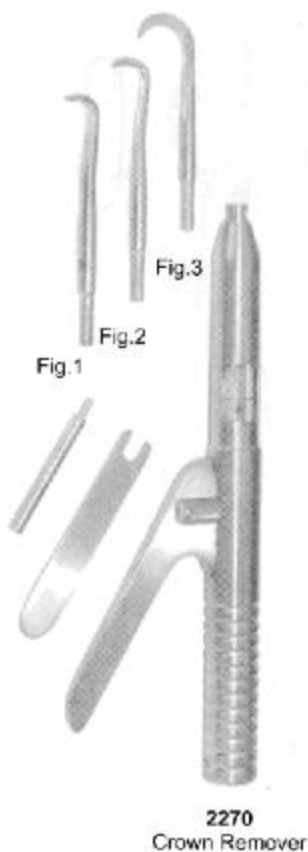
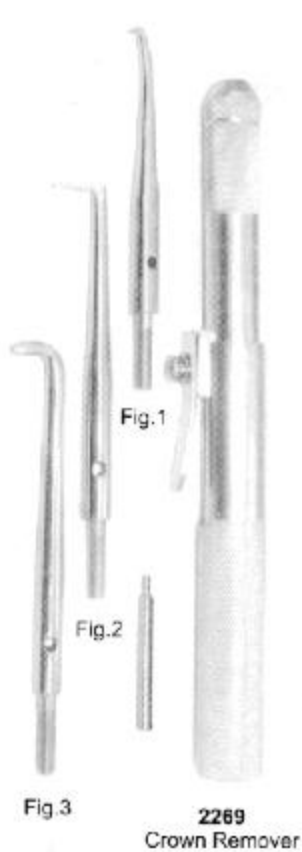

# BONE INSTRUMENTS



**2282**  
Plaster Shear  
210 mm

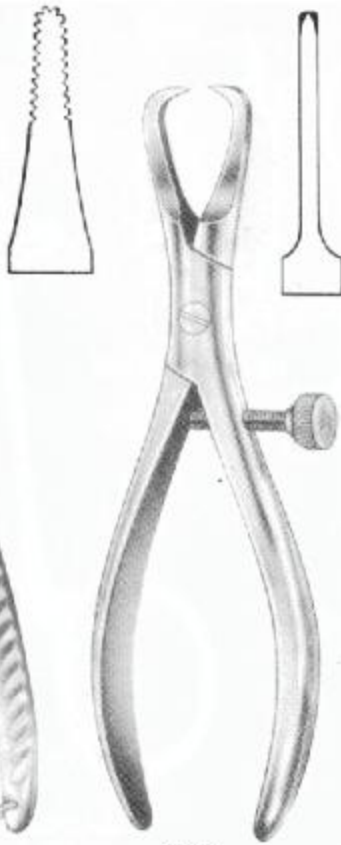

**2283**  
Crown Removing Plier  
14 cm

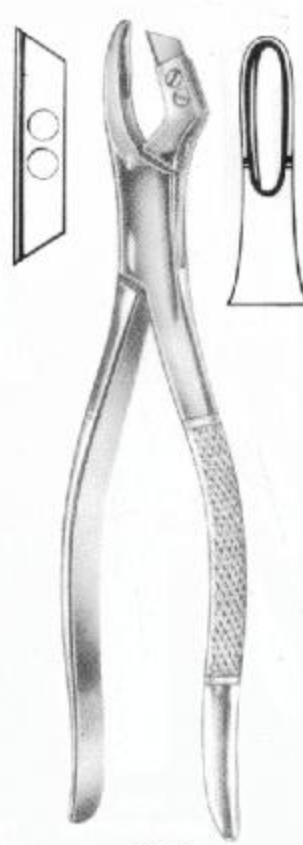

**2284**  
MONTFORT  
18 CM

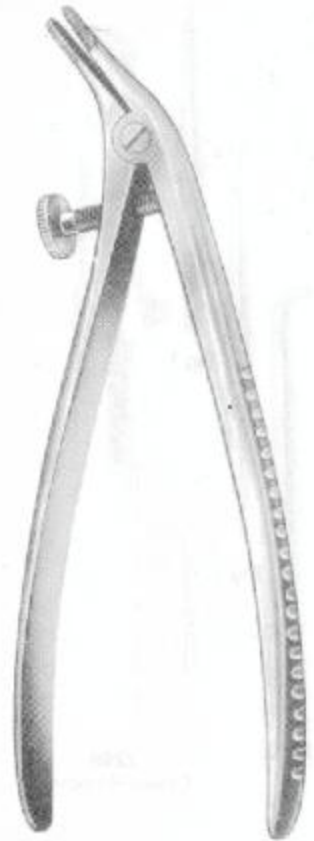

**2285**  
BOHM  
16 cm



**2286**  
Telescope Crown  
Plier, Diamond coated  
13.0 cm



**2287**  
Telescope Crown  
Plier, Diamond coated  
13.0 cm



**2288**  
Telescope Crown Plier  
13.0 cm gerieften Maul  
15.0 cm gerieften Maul  
13.0 cm gelatts Maul



**2289**  
Telescope Crown  
Plier, Fine  
15.0 cm

# IMPLANTS INSTRUMENTS

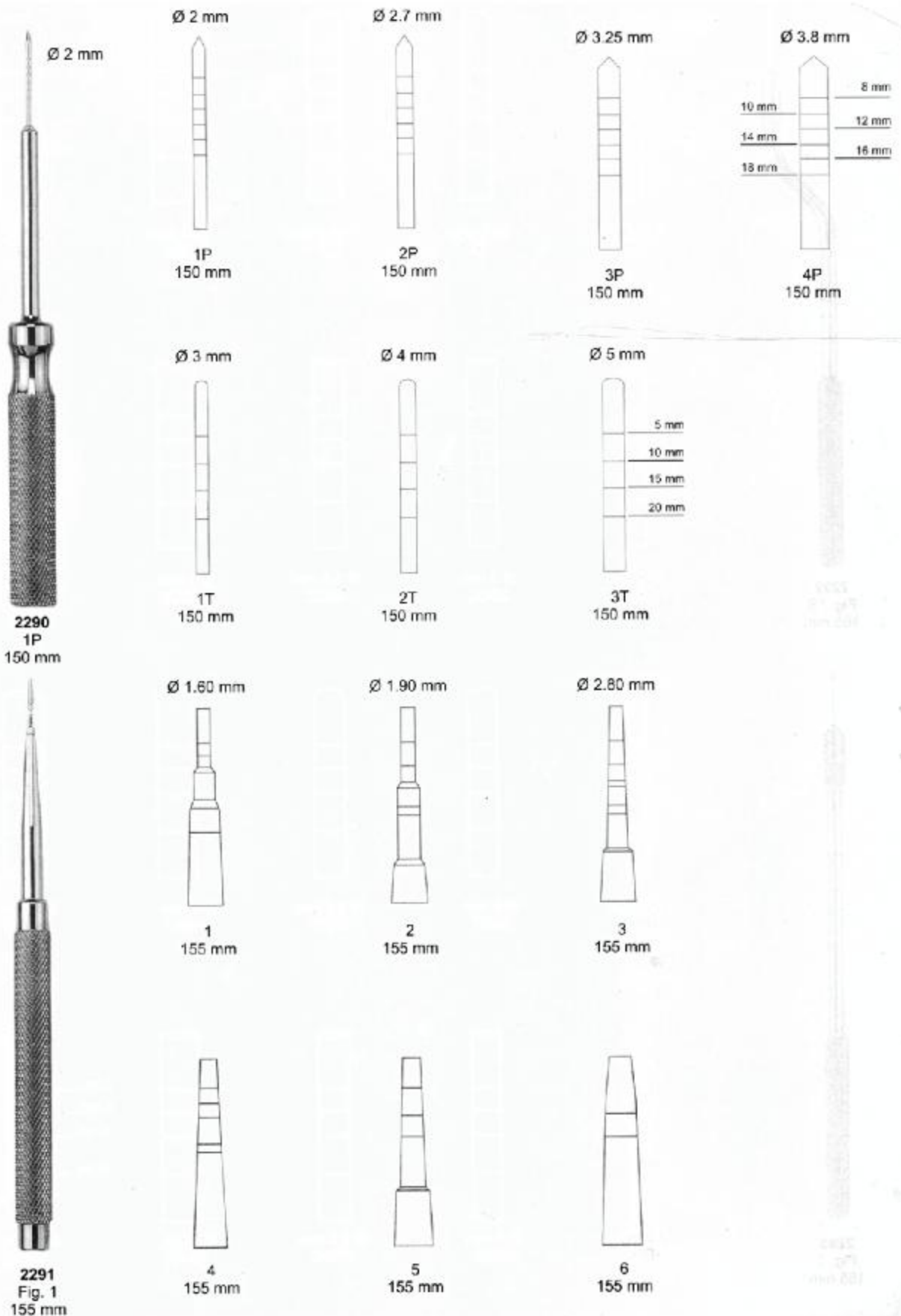





**2292**  
Fig. 1B  
165 mm

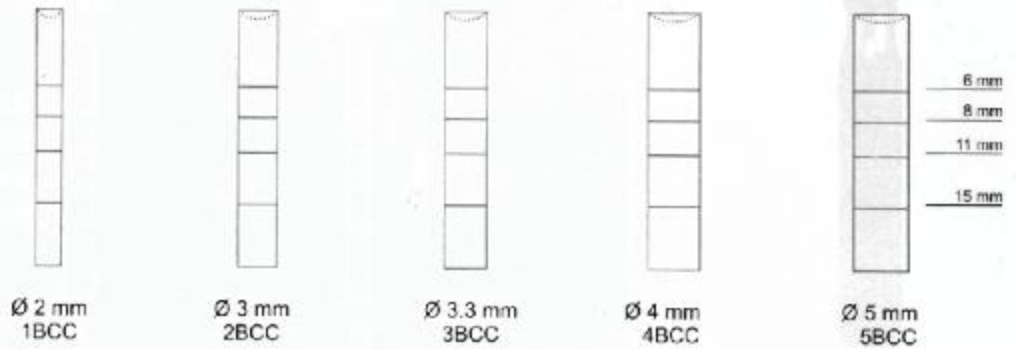
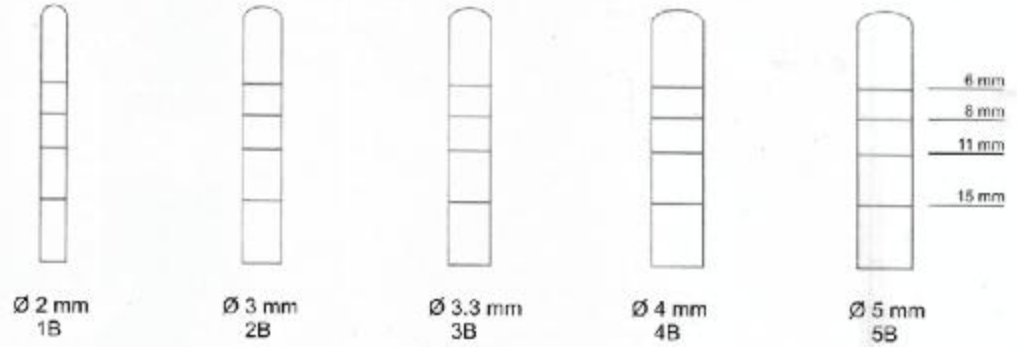

**2293**  
Fig. 1  
155 mm

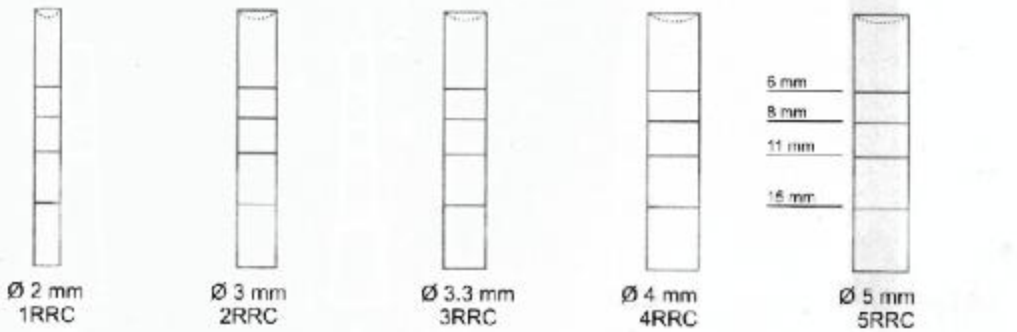
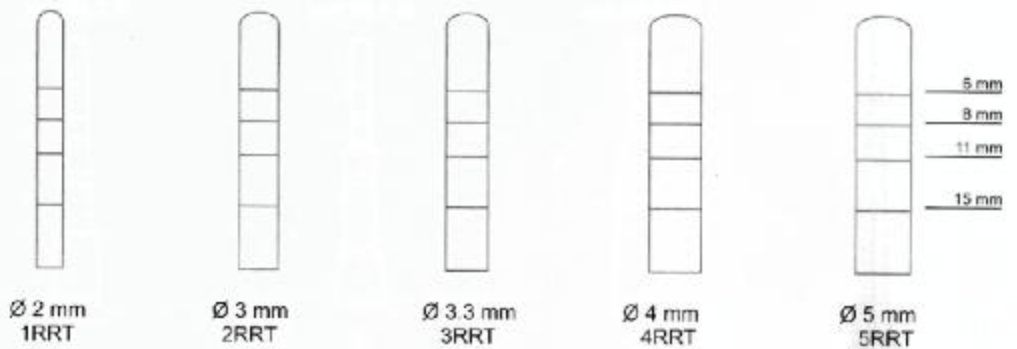

## Endo guns for retrograds.

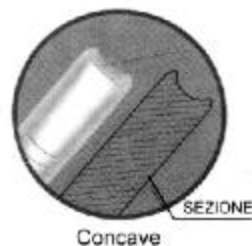
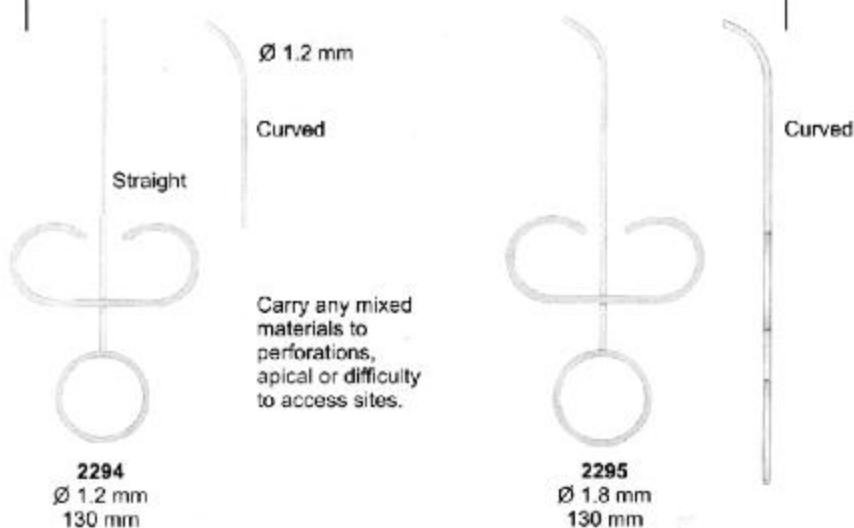

## Bone Injectors

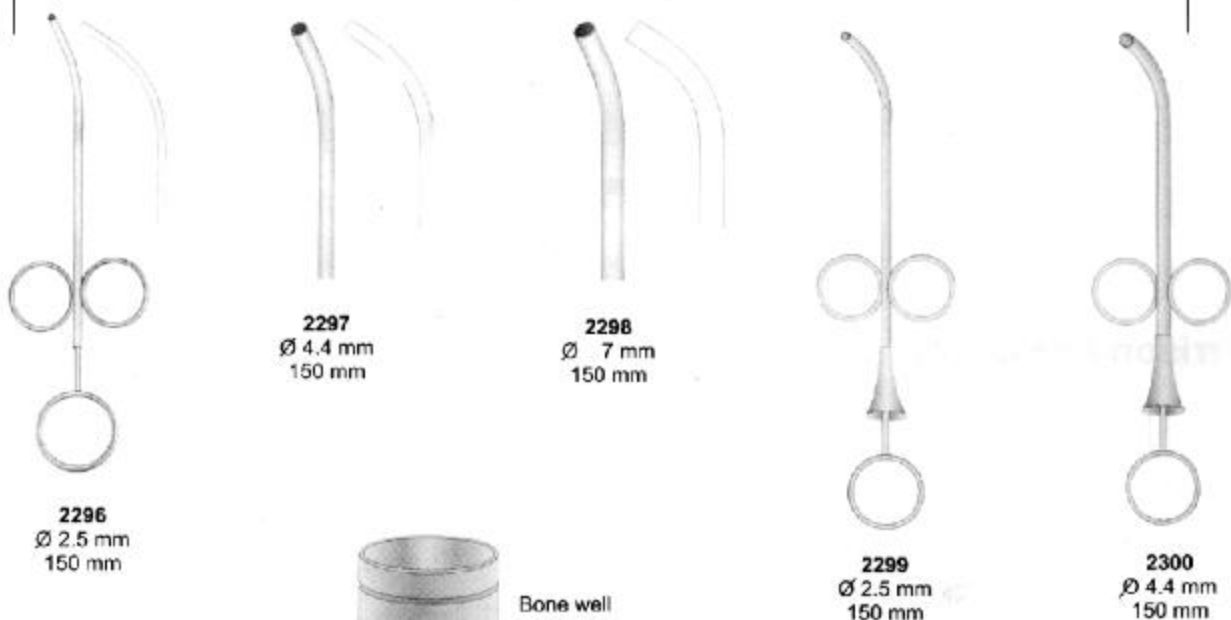

**2301**  
Ø 35 mm  
h 35 mm

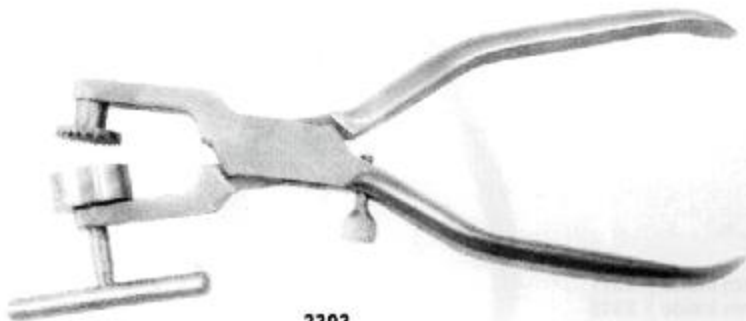

## SUCTION TUBES

### / BONE PLUGGERS & RONGEURS

#### Suction Tubes

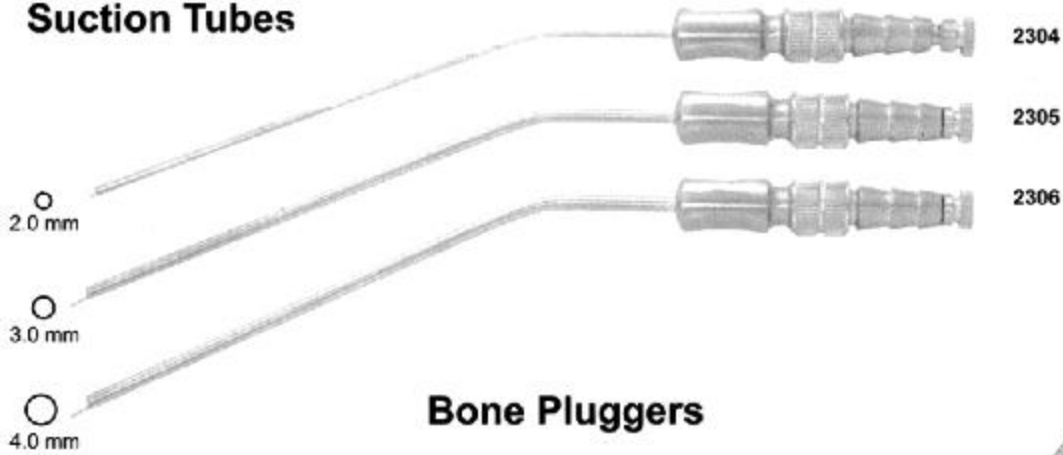

#### Bone Pluggers

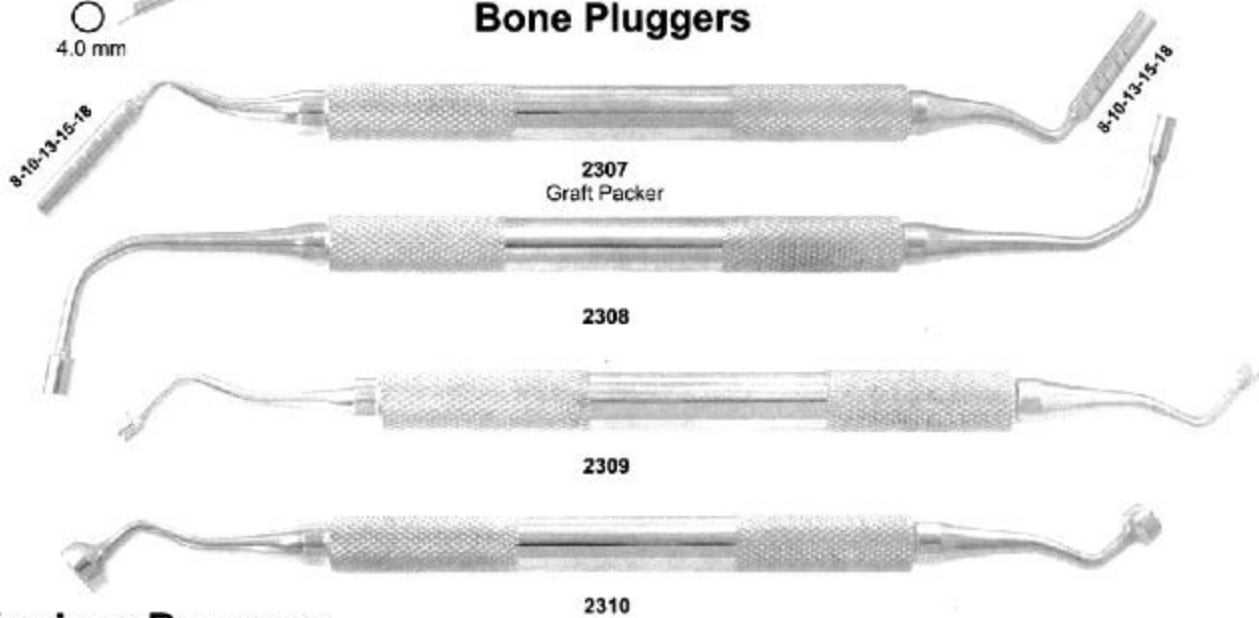

#### Kerrison Rongeurs



- ( 1.5 mm inside ) 2311
  - ( 2.0 mm inside ) 2312
  - ( 3.0 mm inside ) 2313
  - ( 4.0 mm inside ) 2314
  - ( 4.5 mm inside ) 2315
- 16.5 cm**



- ( 1.0 mm inside ) 2316
  - ( 2.0 mm inside ) 2317
  - ( 2.50 mm inside ) 2318
- 16.5 cm**

# IMPLANTS INSTRUMENTS



**2319**  
Fig. 1  
170 mm



**2320**  
Fig. 2  
175 mm



**2321**  
Fig. 3  
170 mm



**2322**  
LUCAS  
Fig. 68  
170 mm

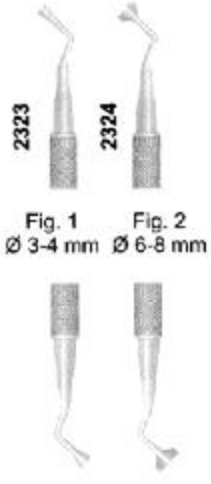

**2323**  
Fig. 1  
Ø 3-4 mm

**2324**  
Fig. 2  
Ø 6-8 mm

Bone Compactors.

TERPHINE burs with depth marking

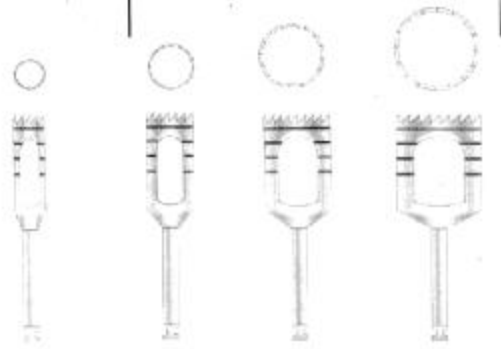

**2325** Ext. Ø 3.5 mm Int. Ø 3 mm

**2326** Ext. Ø 6 mm Int. Ø 5 mm

**2327** Ext. Ø 8.5 mm Int. Ø 7.55 mm

**2328** Ext. Ø 11 mm Int. Ø 10 mm

Sinus lift instruments



**2329**  
Fig. 1



**2330**  
Fig. 2



**2331**  
Fig. 3



**2332**  
Fig. 4



**2333**  
Fig. 5



**2334**  
Fig. 6



**2335**  
Fig. 7



**2336**  
Fig. 8



**2337**  
Fig. 9

# SUCTION TUBES

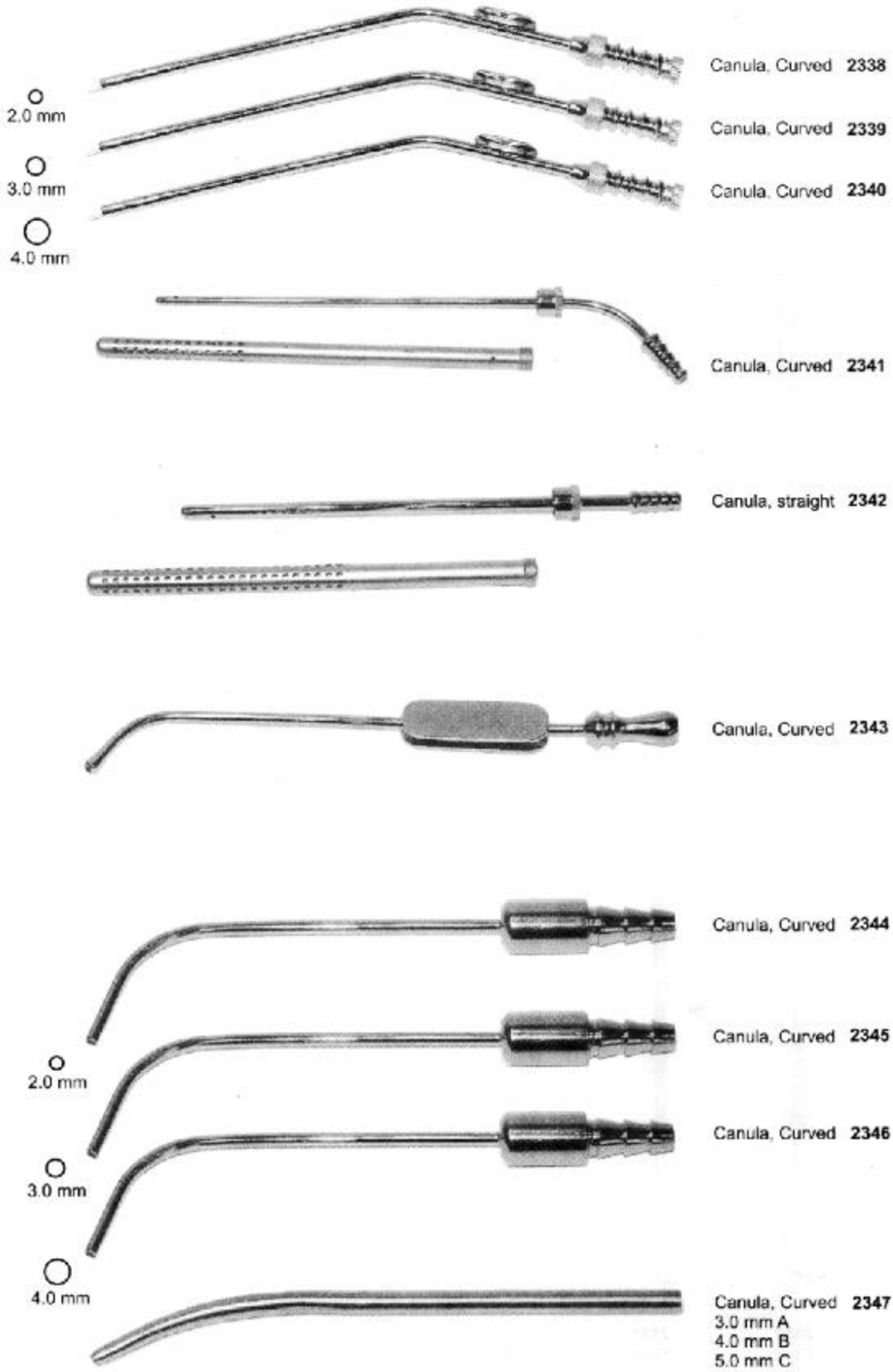

# MEASURING INSTRUMENTS



**2348**  
BOLEY Gauge



**2349**  
ZURICHER  
130 mm



**2350**  
VERNIER  
12 cm



**2351**  
VERNIER



**2352**  
VERNIER Gauge



**2353**  
VERNIER Gauge



**2355**  
Finger Ruler



**2354**  
LWANSON  
Crown Gauge



**2356**  
LWANSON  
Crown Gauge



**2357**  
Sliding Gauge  
10 cm



**2358**  
Spring Bow Divider  
6" Radius



**2359**  
VERNIER  
Gauge

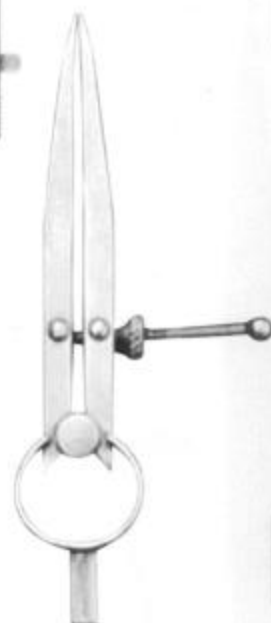

**2360**  
ALBEE



**2361**  
Height Gauge  
Wick Type

# BONE GAUGE

## & MEASURING INSTRUMENTS



**2362**  
Bone Gauge



**2363**  
Bone Caliper  
15 cm



**2364**  
Castroviejo



**2365 B**  
Straight



**2365 A**  
Castroviejo  
Curved



**2366 D**  
Curved

**2366 C**  
Castroviejo  
Straight



**2367**  
Gauge

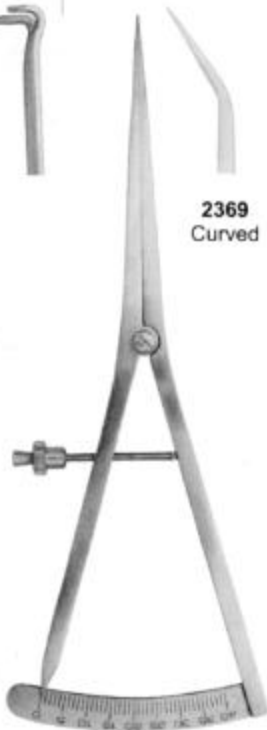

**2368**  
Castroviejo  
Straight



**2369**  
Curved



**2370**  
Castroviejo  
Straight



**2371**  
Curved



**2373**  
Boone - Gauge



**2372**  
Castroviejo



**2374**  
Curved



**2375**  
Straight



**2376**  
Bracket Gauge. Ant/Post

# AMALGAM GUNS

## & CARRIERS



**2377**  
Medium-Large  
20 cm



**2378**  
Medium-Jumbo  
20 cm



**2379**  
Large-Jumbo  
20 cm



**2380**  
Jumbo-Jumbo  
20 cm



**2381**  
Regular-Jumbo  
Silicon Grip  
20 cm

Ø 2 mm



**2382**  
Medium  
15.5 cm

Ø 2.5 mm



**2383**  
Large  
15.5 cm

Ø 3 mm



**2384**  
Jumbo  
15.5 cm



**2385**  
145 mm



**2386**  
130 mm



Ø 2 mm



Ø 2 mm  
**2387**  
Straight  
15 cm



Ø 2 mm  
**2388**  
15 cm



**2389**  
15 cm  
90°



**2390**  
Amalgam Well  
Non Skid Base  
Ø 3.5 mm



# RETAINERS / BANDS

## / STRIP HOLDER CLIPS / NAPKIN HOLDERS

### Retainers



**2391**  
No. 1



**2392**  
No. 8



**2393**  
No. 9

### "Tofflemire" Type Retainers



**2394**  
JUNIOR-CA



**2395**  
SENIOR-CA



**2396**  
UNIVERSAL

### Napkin Holders



Set of 10  
**2402**  
Film Hanger



**2403**  
BALL CHAIN



**2404**  
NON-CHILL  
Clear Plastic

.0015", .002"

**2401**  
X-Ray Holder  
Small



**2405**  
Finger Protector  
Small



**2406**  
Medium



**2407**  
Large



### Strip Holders



**2408**  
Strip Holder Clip  
90°



**2409**  
Strip Holder Clip  
45°

# RUBBER DAM INSTRUMENTS



**2410**  
IRORY  
Light weight, 170 mm



**2411**  
BREWER  
175 mm



**2412**  
BREWER  
175 mm



**2413**  
WHITE  
175 mm



**2414**  
IVORY  
170 mm



**2415**  
AINSWORTH  
Rubber Dam Punch  
170 mm



**2416**  
AINSWORTH  
Rubber Dam Punch  
170 mm



**2417**  
AINSWORTH  
Rubber Dam Punch  
170 mm

## Articulating Paper Forceps



**2421**  
MILLER  
Articulating  
Forceps  
15 cm

**2422**  
MILLER  
Articulating  
Forceps  
15 cm



**2418**  
"IV" Type  
Rubber Dam Punch  
160 mm



**2419**  
Plastic Rubber Dam  
Frame 242

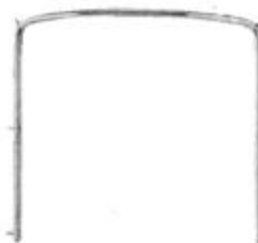

**2420**  
Rubber Dam Holder  
Stainless Steel Pins

# RUBBER DAM CLAMPS

## LOWER MOLARS



**2423**  
76D-W3

**2424**  
76D-3



**2429**  
76D-7A

**2430**  
76D-7



**2435**  
76D-12A

**2436**  
76D-13A



**2441**  
76D-26

**2442**  
76D-28



**2445**  
76D-W8A

**2446**  
76D-8A

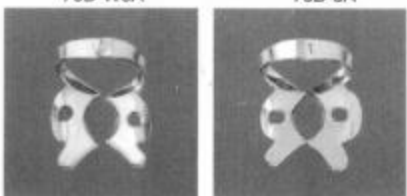

**2447**  
76D-10

**2448**  
76D-11



**2451**  
76D-24

**2452**  
76D-25

## UPPER MOLARS



**2425**  
76D-4

**2426**  
76D-5



**2431**  
76D-8

**2432**  
76D-26N



**2437**  
76D-30

**2438**  
76D-31



**2443**  
76D-201

**2444**  
205

## PREMOLARS



**2427**  
76D-0

**2428**  
76D-1



**2433**  
76D-2A

**2434**  
76D-2



**2439**  
76D-27N

**2440**  
76D-29

## ANTERIOR



**2456**  
76D-00

**2457**  
76D-1A



**2458**  
76D-9

**2459**  
76D-212

## MOLARS

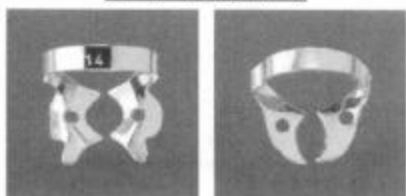

**2449**  
76D-14

**2450**  
76D-118



**2453**  
76D-27

**2454**  
76D-56



**2455**  
76D-14A

# TOFFLEMIRE BANDS

1750-5 mm x 100 cm  
 1750-6 mm x 100 cm  
 1750-7 mm x 100 cm



2459-1

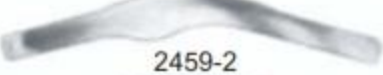

2459-2

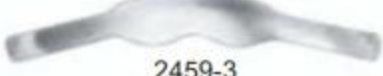

2459-3



2459-4



7

2459-5  
Molar  
Fig. 7



2459-6



2459-7



2459-8



8

2459-9  
Molar  
Fig. 8



9

2459-10  
Molar  
Fig. 9



10

2459-11  
Molar  
Fig. 10



1

2459-12  
Tofflemire



2

2459-13  
Tofflemire



3

2459-14  
Tofflemire



11

2459-15  
Bicuspid



12

2459-16  
Bicuspid



13

2459-17  
Bicuspid



2459-18  
Bicuspid



2459-19  
Bicuspid



2459-20  
Bicuspid



2459-24  
Molars



2459-21  
Molars



2459-22  
Molars



2459-23  
Molars

# ASPIRATING SYRINGES

4969/CO



4969/F



4969/CV



**2460**  
ml 1,8  
EU



**2461**  
ml 1,8  
EU/AM



**2462**  
ml 1,8  
EU/AM



**2463**  
Fig. 1  
ml 1,8  
EU



**2464**  
Fig. 1  
ml 1,8  
EU



**2465**  
SS INOX  
All inox & autoclavable  
black plastic handle  
passive automatic  
aspiration.



**2466**  
Fig. 1  
ml 1,8  
EU/Am



**2467**  
Fig. 1  
ml 1,8  
EU/Am



**2468**  
Fig. 1  
ml 1,8  
EU/Am

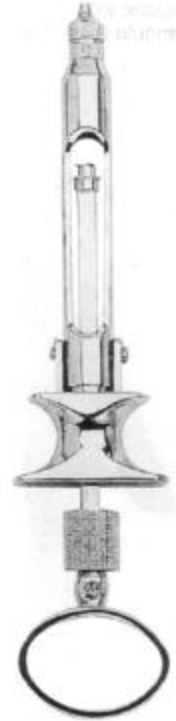

**2469**  
ml 1,2  
EU/Am

# SYRINGES



**2470**  
Water Syringe  
complete with  
1 cannula (Lure-Lock)

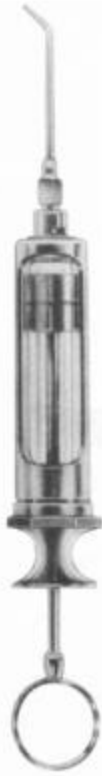

**2471**  
Water Syringe  
complete with  
1 cannula (Lure-Lock)



**2472**  
Metal Water Syringe  
self-filling, with 1  
cannula (Lure-Lock)



**2473**  
Sparrel Barrel with  
plunger suitable for  
syringes.



**2474**  
Cannula, only, with  
Luer-Lock connector  
suitable for syringes



**2475**  
Articulating  
Barrel Syringe



**2476**  
ml 1,8



**2477**  
ml 1,8



**2478**



**2480**



**2481**  
Fig. 1  
ml 1,8 EU



**2485**  
Fig. 1  
ml 1,8 EU



**2482**  
Water  
point



**2483**  
Water  
point



**2484**  
Water  
point

# DENTAL TWEZERS



**2486**  
ADSON  
Curved 14 cm



**2487**  
ADSON  
1X2 / 12 cm



**2488**  
ADSON  
12 cm



**2489**  
MICRO ADSON  
15 cm



**2490**  
STANDARD  
14,18,25 cm



**2491**  
CUSHING  
18 cm



**2492**  
Curved



**2493**  
SELECT  
15,18,20 cm

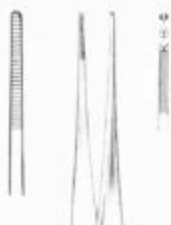

**2494**



**2495**  
MCINDOE  
15 cm



**2496**  
GILLIES  
15 cm



**2497**  
WAUGH  
15,20 cm



**2498**  
PERRY  
13 cm

Serrated



**2499**  
KOPP  
15.5 cm

# DENTAL TWEZERS



**2500**  
COLLEGE  
15 cm

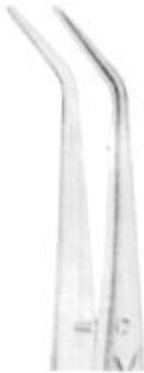

smooth



**2501**  
COLLEGE  
15 cm



serrated



**2502**  
COLLEGE  
15 cm



smooth



**2503**  
COLLEGE  
15 cm



serrated



**2504**  
COLLEGE  
15 cm



smooth



**2505**  
COLLEGE  
15 cm



serrated



**2506**  
COLLEGE  
15 cm



smooth



**2507**  
COLLEGE  
15 cm



serrated



# DENTAL TWEZERS



**2508**  
MERIAM  
16 cm



smooth



**2509**  
MERIAM  
16 cm



serrated



**2510**  
MERIAM  
16 cm



smooth



**2511**  
MERIAM  
16 cm1



serrated



**2512**  
MERIAM  
16 cm



smooth



**2513**  
MERIAM  
16 cm



serrated



**2514**  
MERIAM  
16 cm



smooth



**2515**  
MERIAM  
16 cm



serrated

# DENTAL TWEZERS

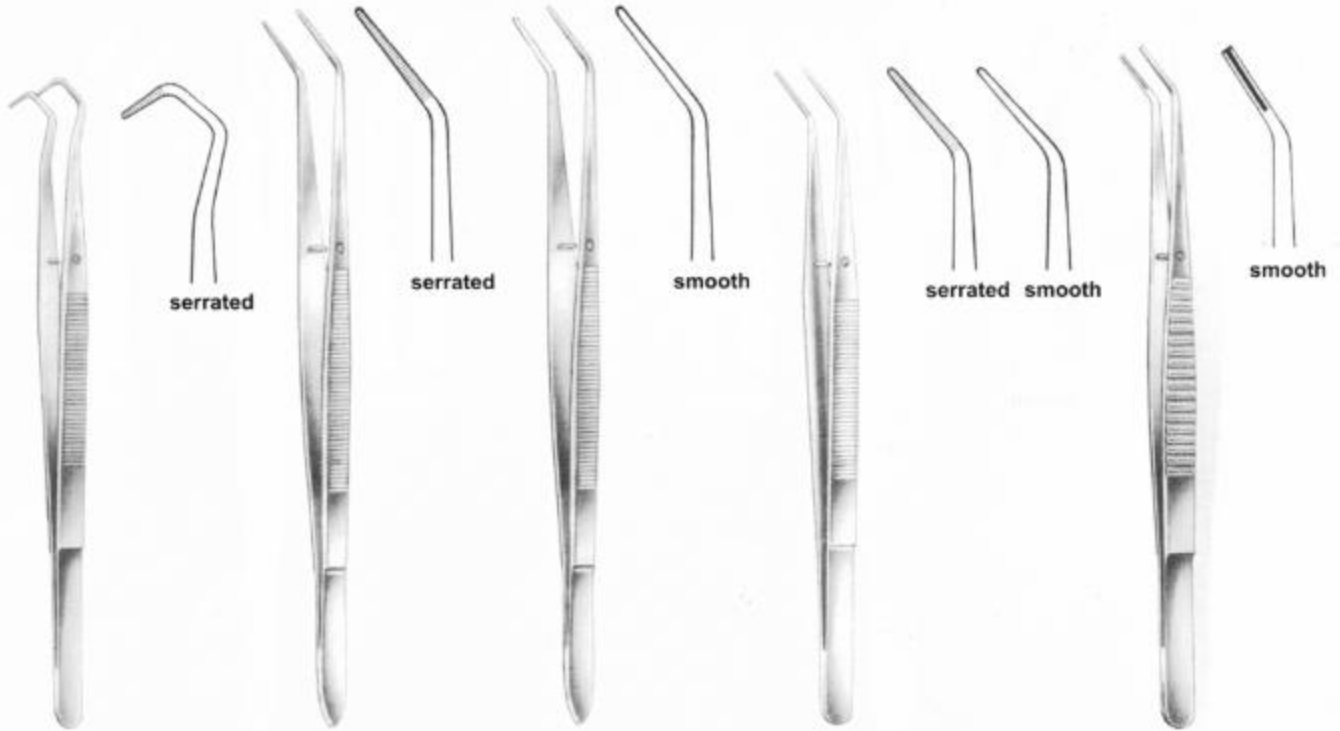

**2516**  
COLLEGE  
14.5 cm, 5<sup>3</sup>/<sub>4</sub>"

**2517**  
FLAGG  
16 cm, 6<sup>1</sup>/<sub>4</sub>"

**2518**  
FLAGG  
16 cm, 6<sup>1</sup>/<sub>4</sub>"

**2519**  
LANDGRAF  
15 cm, 6"

**2520**  
15.5 cm, 6<sup>1</sup>/<sub>8</sub>"

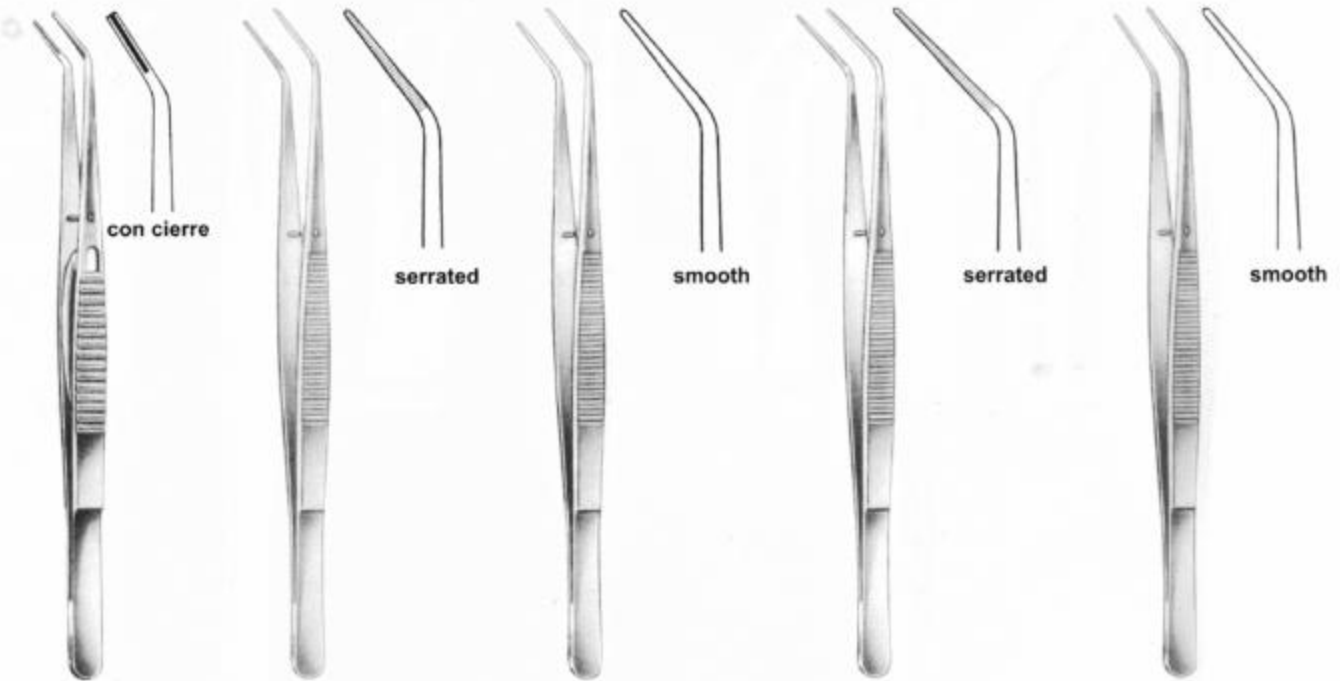

**2521**  
15.5 cm, 6<sup>1</sup>/<sub>8</sub>"

**2522**  
LONDON-COLLEGE  
15 cm, 6"

**2523**  
LONDON-COLLEGE  
15 cm, 6"

**2524**  
LONDON-COLLEGE  
15 cm, 6"

**2525**  
LONDON-COLLEGE  
15 cm, 6"

# DENTAL TWEZERS



**2526**  
LONDON-COLLEGE  
15 cm, 6"



**2527**  
LONDON-COLLEGE  
15 cm, 6"



con cierre



**2528**  
MERIAM  
16 cm, 6 1/4"



serrated



smooth



**2529**  
ALLEN  
18 cm, 7 1/8"



**2530**  
ALBRECHT  
16 cm, 6 1/4"



**2531**  
ALBRECHT  
16 cm, 6 1/4"



**2532**  
16 cm, 6 1/4"



**2533**  
16 cm, 6 1/4"



**2534**  
16 cm, 6 1/4"



# STERILIZING

## & LAB INSTRUMENTS



**2535**  
DAVIS  
6"



**2536**  
Grasping Forceps  
6 1/4"



**2537**  
Mesh Bur & Diamond Holder  
Large, 2 1/8" Diameter



**2538**  
Soldering Tweezers  
6 1/4"



**2539**  
Narrow Fine  
4 3/4"



**2540**  
Super Fine  
4 3/8"



**2541**  
Fine Curved  
4 1/2"



**2542**  
Bonding Bracket  
Holder  
136 mm



**2543**  
Bonding Bracket  
Holder  
135 mm



**2544**  
Bonding Bracket  
Holder  
135 mm



**2545**  
Bonding Bracket  
Holder  
140 mm

# ENDODONTIC FORCEPS



**2546**  
Endo Forceps  
4 3/4"



**2547**  
PEETS Forceps  
4 3/4", Useful For  
Removing Broken  
Instruments

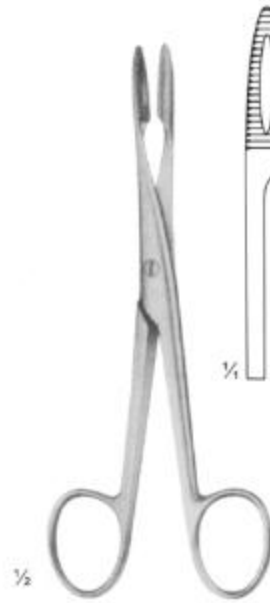

**2548**  
Without Ratchet  
145 mm

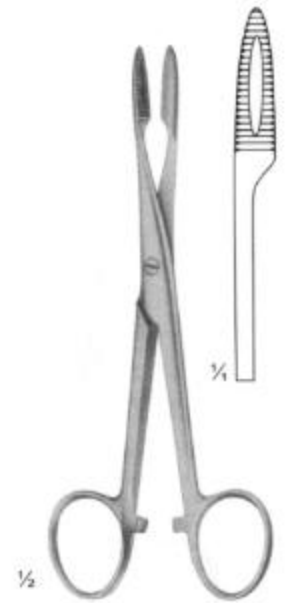

**2549**  
With Ratchet  
145 mm



**2550**  
CRILE  
140 mm

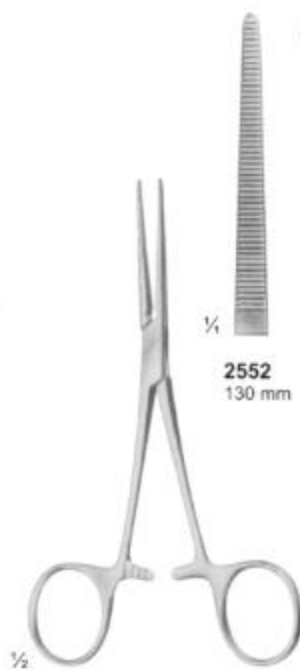

**2551**  
PEAN  
Slender type



**2552**  
130 mm



**2553**  
140 mm



**2554**  
SPENCER-WELLS

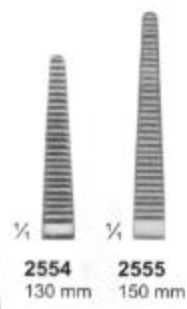

**2554**  
130 mm



**2555**  
150 mm

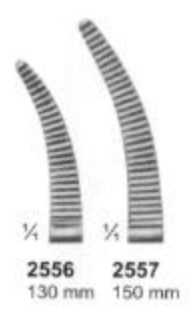

**2556**  
130 mm



**2557**  
150 mm

# TISSUE FORCEPS



**2558**  
BABY-ALLIS  
5", Straight  
4x5 teeth extra delicate



**2559**  
ALLIS  
6", Straight  
4x5 teeth extra delicate



**2560**  
ALLIS  
6", Straight  
4x5 teeth extra delicate



**2561**  
1x2 teeth  
6"



**2562**  
SEMKIN  
6", Straight,  
1x2 teeth



**2563**  
ADSON  
4 3/4"  
1x2 teeth



**2564**  
BROWN-ADSON  
4 3/4"  
7x7 teeth



**2565**  
BROWN  
6"  
8x8 teeth



**2566**  
RUSSIAN  
6"  
8x8 teeth



**2567**  
Extra-Delicate,  
Straight, 4"  
1x2 teeth

## HEMOSTATIC FORCEPS

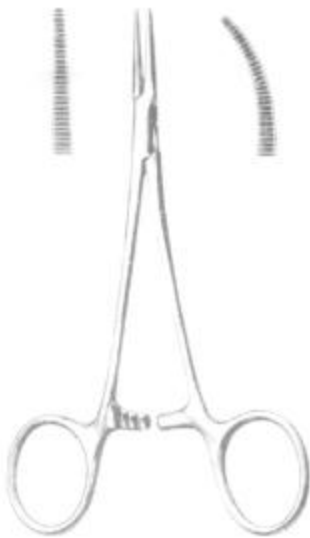

**2568**  
HALSTED-MOSQUITO  
Straight, Curved, 5"

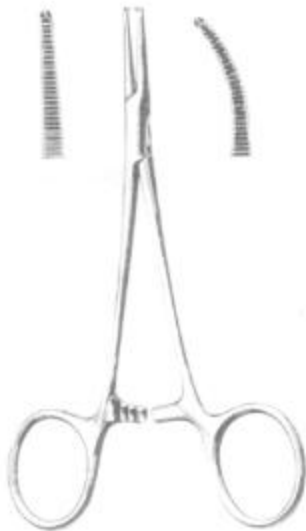

**2569**  
HALSTED-MOSQUITO  
Straight, Curved, 5"  
1x2 teeth



**2570**  
HALSTED-MOSQUITO  
Jaws 45 Angled on Flat, 5"  
Extra Delicate



**2571**  
KELLY  
5 1/2", Straight



**2572**  
JONES  
3 1/2"



**2573**  
BACKHAUS  
3 1/2"



**2574**  
BACKHAUS  
5 1/4"



**2575**  
LORNA  
Non Perforated  
3 1/2"

# RETRACTORS

## DEPRESSORS / MOUTH GAGS



**2576**  
DENHART



**2577**  
DENHARDT  
Mouth Gag With  
Silicon Inserts,  
Interchangeable  
Size: 125 mm

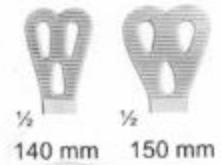

**2578** 1/2  
WIEDER  
Tongue depressor  
**2579** 140mm  
**2580** 150mm



**2581**  
TOBOLD  
Tongue depressor  
Size: 145 mm



**2582**  
ANDREW  
Tongue depressor  
Size: 110 mm



**2583**  
WEITLANER  
Sharp  
130 mm

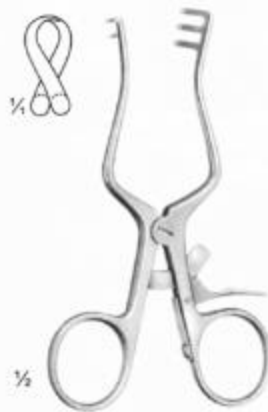

**2584**  
WEITLANER  
Sharp  
110 mm

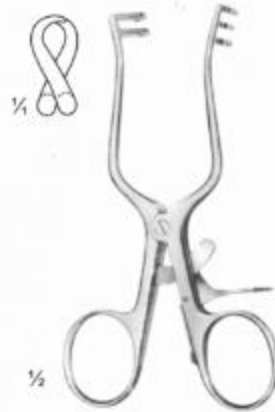

**2585**  
WEITLANER  
Semi-Sharp  
110 mm



**2586**  
MOLT  
Pediatric



**2587**  
MOLT  
Child



**2588**  
MOLT  
Adult



**2589**  
FERGUSSON-ACKLAND  
Mouth Gag  
Size: 145 mm



**2590**  
ROSER KOENIG  
Mouth Gag  
Size: 160mm / 185mm



## LIP & CHEEK RETRACTORS



**2591**  
140 mm



**2592**  
BRUENINGS  
190 mm



**2593**



**2594**



**2595**



**2596**



**2597**



**2598**



**2599**  
Mouth Gag with  
Tongue Depressor  
11.0 cm  
13.0 cm  
15.0 cm

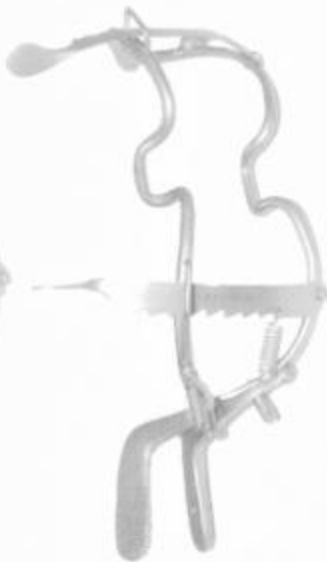

**2600**  
Mouth Gag without  
Tongue Depressor  
11.0 cm  
13.0 cm  
15.0 cm



**2601**  
Jennings, Mouth Gag  
11.0 cm  
13.0 cm  
15.0 cm



**2602**



**2603**

# LIP & CHEEK RETRACTORS

- 30 x 4 mm A
- 23 x 7 mm B
- 24 x 11 mm C
- 29 x 10 mm D
- 30 x 11 mm E
- 32 x 14 mm F
- 40 x 11 mm G
- 42 x 10 mm H
- 50 x 11 mm I
- 55 x 11 mm J
- 60 x 11 mm K
- 70 x 11 mm L
- 70 x 14 mm M



**2604**  
LANGENBECK  
210 mm



**2605**  
KOCHER-LANGENBECK  
215 mm



**2606**  
BUCHS  
205 mm



38 x 18 mm



**2607**  
KOCHER  
230 mm



**2608**  
MIDDELDORPF



**2609**  
15 x 15 mm  
220 mm



**2610**  
20 x 22 mm  
215 mm



**2611**  
28 x 28 mm  
235 mm



**2612**  
KOCHER  
230 mm



**2613**  
COLLIN  
150 mm



**2614**  
ROUX  
Set  
165 mm

## STERILIZING FORCEPS



**2615**  
Sterilizing Forcep Curved  
20 cm A  
25 cm B  
30 cm C



**2616**  
Sterilizing Forcep Straight  
20 cm A  
25 cm B  
30 cm C



**2617**  
Sterilizing Forcep  
30 cm



**2618**  
Becht Tweezer



**2619**  
Sterilizing Forcep  
23 cm A  
30 cm B



**2620**  
Sterilizing Forcep  
20 cm

# TISSUE RETRACTORS & HOOKS



**2621**  
3 sharp prongs



**2622**  
2 sharp prongs  
6"



**2623**  
2 sharp prongs  
6"



**2624**  
FOMON  
145 mm



**2625**  
ALM  
70 mm



**2626**  
SENN  
3 sharp prongs  
6 3/8"



**2627**  
TOENNIS  
Dura Retractor  
150mm



**2628**  
JOSEPH  
165 mm



**2629**  
GILLIES  
180 mm

## ORTHODONTIC PLIERS



**2630**  
Light Wire Cutter



**2631**  
Wire Cutter



**2632**  
Posterior Band Remover  
Long



**2633**  
Posterior Band Remover  
Short



**2634**  
Jarabak Plier



**2635**  
Distal End Cutter  
Safety End Cutter



**2636**  
Distal End Cutter

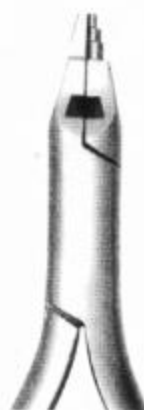

**2637**  
Kim's Plier



**2638**  
Loop Forming Plier



**2639**  
Tweed Arch Bending Plier



**2640**  
Utility Plier



**2641**  
Bonding Bracket Remover



**2642**  
Lingual Arch Plier



**2643**  
Light Wire Plier



**2644**  
Wire Cutter  
12.5 cm

# ORTHODONTIC PLIERS

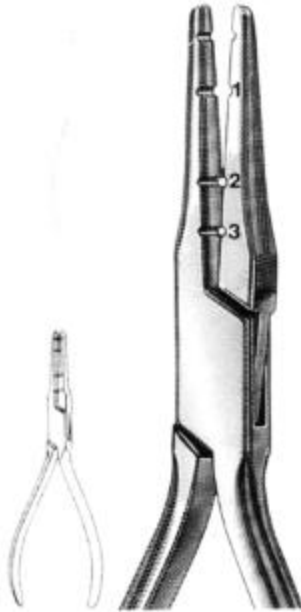

**2645**  
Fig. 101  
Wire Bending

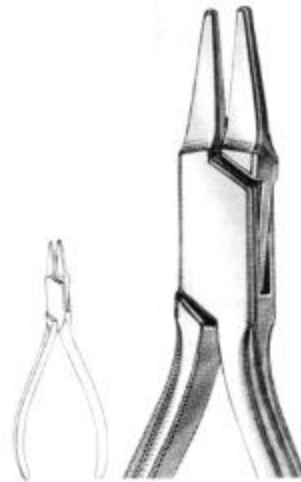

**2646**  
Fig. 118  
PEESO  
Collar



**2647**  
Fig. 417  
Crown Shell

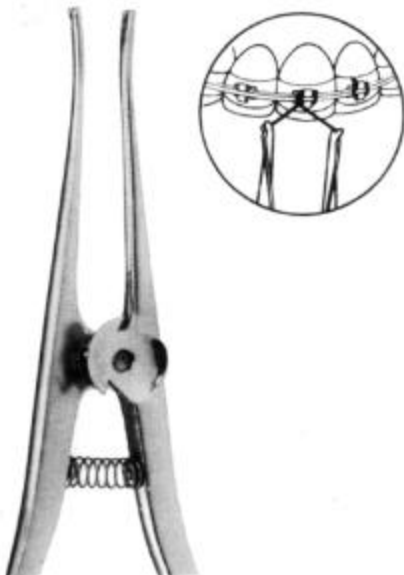

**2648**  
STEINER  
150 mm  
Ligature Pliers

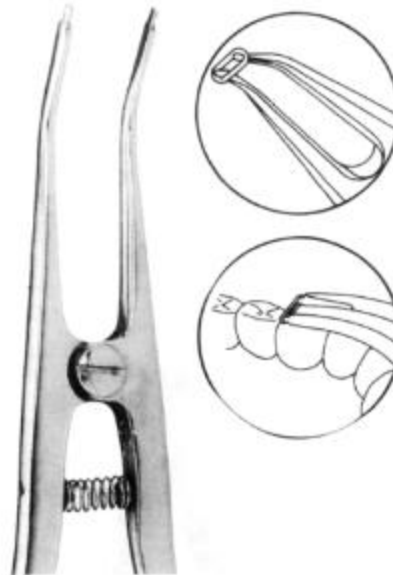

**2649**  
Separating Pliers Elastics  
150 mm



**2650**  
121-Lab & Office

# ORTHODONTIC PLIERS



**2651**  
How Plier-Titanium Alloy  
With special coated beaks

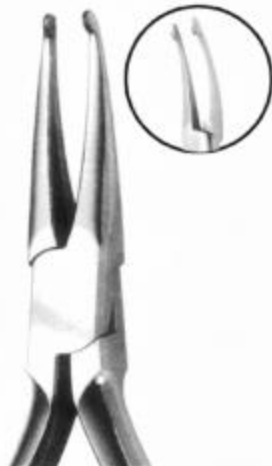

**2652**  
How Plier  
Tips are 1/8" (3.2mm)  
diameter



**2653**  
How Plier  
Tips are 1/8" (3.2mm)  
diameter



**2654**  
How Plier-Small  
Tips are 3/32" (2.4mm)  
diameter



**2655**  
How Plier-Offset  
Tips are 1/8" (3.2mm)  
diameter



**2656**  
Weingart Utility Plier  
-Titanium Alloy  
with special coated beaks



**2657**  
Weingart Utility Plier  
New type of the Weingart Utility Plier  
designed for a more precise operation.



**2658**  
Weingart Utility Plier



**2659**  
Weingart Utility Plier



**2660**  
Weingart Utility Plier



**2661**  
Bird Beak Plier With Cutter  
**Maximum Bending & Cutting Capacity:**  
Wires up to .032"



**2662**  
Bird Beak Plier  
**Maximum Bending Capacity:**  
Wires up to .032"



**2663**  
Bird Beak Plier  
**Maximum Bending Capacity:**  
Wires up to .030"

# ORTHODONTIC PLIERS



**2664**  
TWEED (Fig. 98)  
13 cm, 5 1/8"  
Tweed Loop Omega Pliers.



**2665**  
TWEED - (Fig. 90)  
14 cm, 5 1/2"



**2666**  
O'BRIEN - (Fig. 97)  
14 cm, 5 1/2"



**2667**  
TWEED (Fig. 96)  
14 cm, 5 1/2"

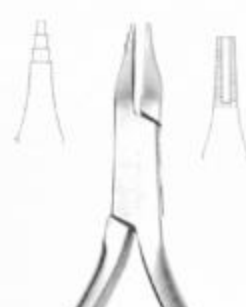

**2668**  
TWEED (Fig. 95)  
13.5 cm, 5 1/4"

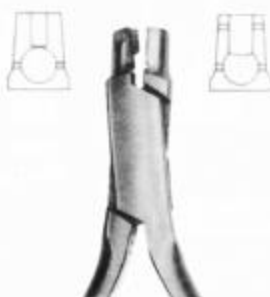

**2669**  
SCHWARZ (Fig. 29)  
12.5 cm, 5"



**2670**  
NANCE (Fig. 80)  
13 cm, 5 1/8"

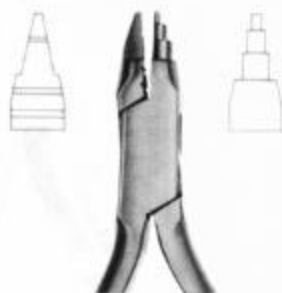

**2671**  
YOUNG (Fig. 55)  
13 cm, 5 1/8"



**2672**  
SCHWARZ (Fig. 30)  
13 cm, 5 1/8"

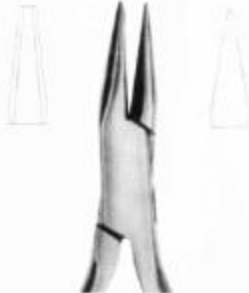

**2673**  
Optical Plier (Fig. 53)  
14 cm, 5 1/2"



**2674**  
Schwarz (Fig. 79)  
13.5 cm, 5 1/4"



# ORTHODONTIC PLIERS



**2675**  
NANCE (Fig. 56)  
12.5 cm, 5"  
Wire bending Pliers



**2680**  
14.0 cm  
Goslee Contouring Plier



**2676**  
JOHNSON (Fig. 59)  
13.5 cm, 5 1/4"  
Contouring Plier.



**2678**  
De La Rosa (Fig. 34)  
12.5 cm, 5"  
Contouring Plier, Non-Grooved



**2677**  
REYNOLDS (Fig. 61)  
13 cm, 5 1/8"  
Contouring Plier.



**2679**  
De La Rosa (Fig. 35)  
12.5 cm, 5"  
Contouring Plier, Grooved



**2681**  
14.0 cm  
Goslee Contouring Plier

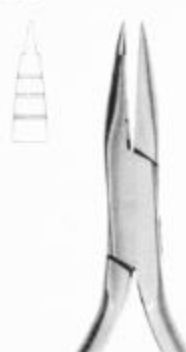

**2682**  
**2683**  
Fig. 58  
12.5 cm, 5"  
Lingual Arch Bending Plier



**2684**  
Frevort/Tweed (Fig. 51)  
12.5 cm, 5"  
Tweed Arch Plier/Standard Jaw



**2685**  
**2686**  
ANGLE (Fig. 52)  
13 cm, 5 1/8"  
Arch Forming Plier

# ORTHODONTIC PLIERS



**2687**  
Fig. 60  
13 cm, 5 1/8"  
Wire & Clasp Bending Pliers



**2688**  
Fig. 60  
13 cm, 5 1/8"  
Wire & Clasp Bending Pliers

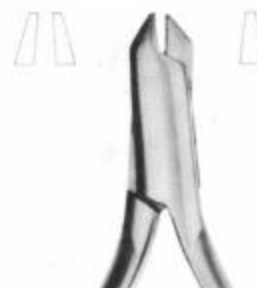

**2689**  
Aderer (Fig. 57)  
12 cm, 4 3/4"  
Wire & Clasp Bending Pliers



**2690**  
49 e 49 TC  
14 cm, 5 1/2"  
Band Removing Plier, short pad



**2691**  
50 e 50 TC  
14 cm, 5 1/2"  
Band Removing Plier, long pad



**2692**  
Fig. 84  
14.5 cm, 5 3/4"  
Band pinshing & ligature locking plier, serrated



**2693**  
Fig. 72  
14 cm, 5 1/2"  
Band pinshing & ligature locking plier, serrated



**2694**  
BRACKET (Fig. 82)  
13.5 cm, 5 1/4"  
Direct Bonding Bracket Remover



**2695**  
BRACKET (Fig. 83)  
13.5 cm, 5 1/4"  
Direct Bonding Bracket Remover

# ORTHODONTIC PLIERS



**2696**  
38c, 38TC  
13.5 cm, 5 1/4"  
Contouring closing loop pliers,  
wire bending, cutter.



**2697**  
40c, 40TC  
13.5 cm, 5 1/4"  
Contouring pliers light wire pliers  
grooved with cutter.



**2698**  
Fig. 81  
12.5 cm, 5"  
Sling clasp & wire bending plier



**2699**  
Fig. 28  
14 cm, 5 1/2"  
Sling clasp & wire bending plier.



**2700**  
Fig. 21  
13 cm, 5 1/8"  
Light wires pliers, grooved



**2704**  
46c - 46 TC  
ADAMS - N. 139c  
12.5 cm, 5"  
Bird beak with cutter.



**2701**  
ADAMS, 23, 23TC  
12.5 cm, 5"  
Sling clasp & wire bending plier.



**2702**  
ADAMS (Fig. 33)  
12.5 cm, 5"  
For retaining elements.



**2703**  
ADAMS (Fig. 44)  
12.5 cm, 5"  
Sling clasp & wire bending plier.



**2705**  
Universal Wire Bending  
Pliers (ADAMS) 47 TC, N.64  
12.5 cm, 5"  
Sling clasp & wire bending plier.



**2706**  
86c, 86 TC  
Angle Bird Beak - N.138  
12.5 cm, 5"  
Sling clasp & wire bending plier.

# ORTHODONTIC CUTTER

WITH T.C.



Ø 1.0 mm  
(0.40")

**2707**  
Fig. 18 TC  
15 cm, 6"



Ø 1.0 mm  
(0.40")

**2708**  
Fig. 92 TC  
14 cm, 5 1/8"



Ø 0.4 mm  
(0.16")

**2709**  
Fig. 91 TC  
13 cm, 5 1/8"



Ø 0.4 mm  
(0.16")

**2710**  
Fig. 99 TC  
13 cm, 5 1/8"



Ø 0.4 mm  
(0.16")

**2711**  
Fig. 94 TC  
13 cm, 5 1/8"  
Angled at 15° with or  
without spring on \  
the handles.



**2712**  
Fig. 85 TC  
13 cm, 5 1/8"



**2713**  
Fig. 87 TC  
13 cm, 5 1/8"



**2714**  
Fig. 85 TC  
Angled at 15°  
13 cm, 5 1/8"



**2715**  
ADAMS 87 TC  
Angled at 15°  
13 cm, 5 1/8"

ORTHODONTIC DISTAL & CUTTER



# PLIERS FOR ORTHODONTIC

## & PROSTHETICS



**2721**  
UNIVERSAL  
150 mm

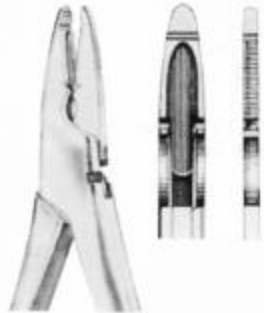

**2722**  
WALDSACHS  
155 mm



**2723**  
ADERER  
125 mm



**2724**  
NANCE  
125 mm



**2725**  
REYNOLDS  
125 mm



**2726**  
HOW  
145 mm



**2727**  
HOW  
140 mm



**2731**  
FURRER  
150 mm



**2728**  
WALDRON  
125 mm



**2729**  
ADAMS  
125 mm



**2730**  
ANGLE  
125 mm

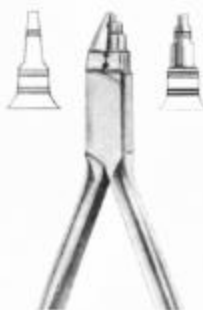

**2732**  
YOUNG  
130 mm



**2733**  
NANCE  
130 mm

# PLIERS FOR ORTHODONTIC

## & PROSTHETICS



**2734**  
LANGEBECK  
125 mm



**2735**  
LANGEBECK  
140 mm



**2736**  
LANGEBECK  
130 mm



**2737**  
PEESO  
125 mm



**2738**  
GOSLEE  
125 mm



**2739**  
FISCHER  
140 mm



**2740**  
FISCHER  
140 mm



**2741**  
JOHNSON  
130 mm



**2742**  
MSY  
130 mm



**2743**  
MC KELLOPS  
155 mm



**2744**  
ANDRESEN  
130 mm



**2745**  
SCHWARZ  
130 mm

# RONGEURS



**2746**  
BLUMENTHAL  
6", 30°, Standard

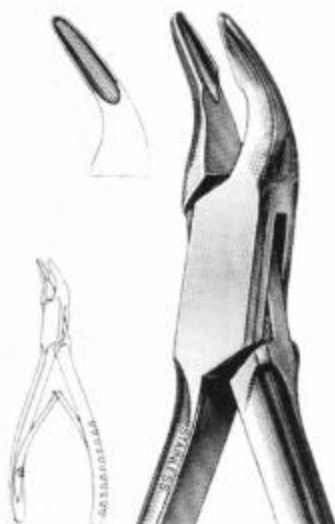

**2747**  
MINI-BLUMENTHAL  
6", 45°

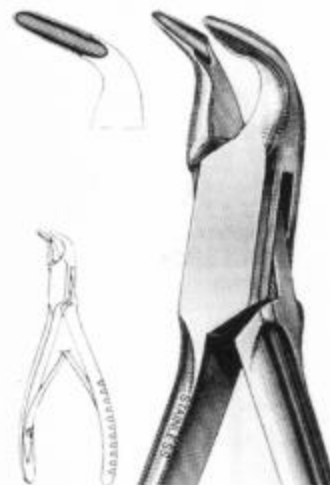

**2748**  
MINI-BLUMENTHAL  
6", 90°

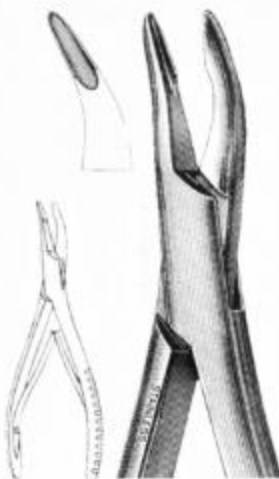

**2749**  
BLUMENTHAL  
7", 30°



**2750**  
MINI-BLUMENTHAL  
4 1/2", 30°



**2751**  
MINI-BLUMENTHAL  
4 1/2", 45°



# RONGEURS

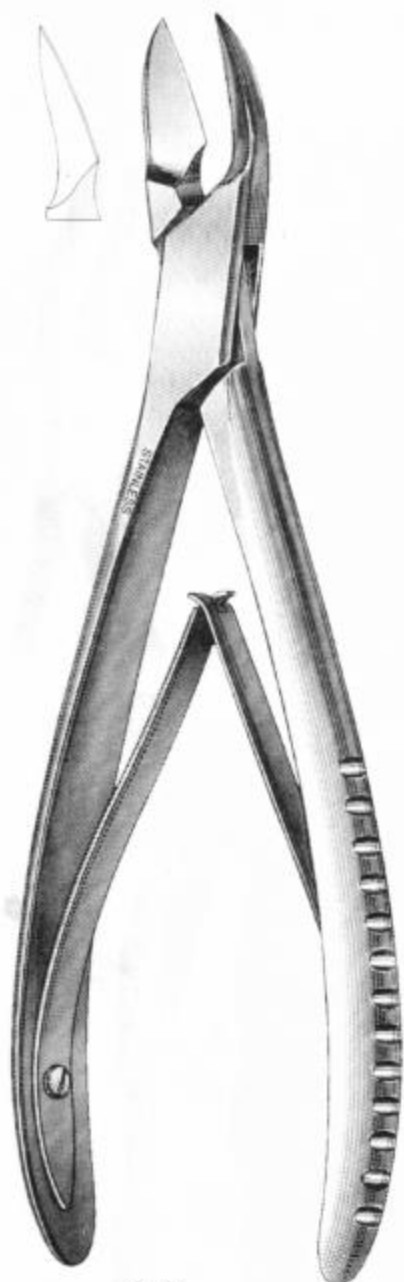

**2752**  
CLEVELAND  
No. 5-Side Cutting,  
6 3/4"

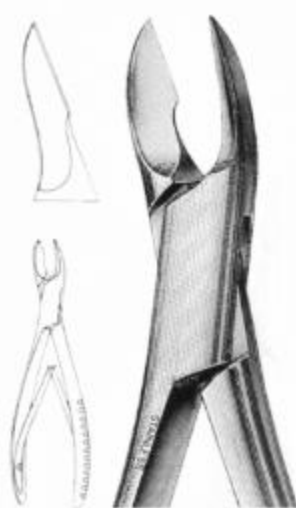

**2753**  
CLEVELAND  
No. 5A-Side Cutting,  
6 1/2"

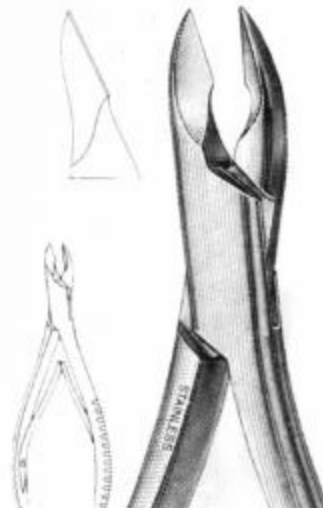

**2754**  
CLEVELAND  
No. 5S-Side Cutting,  
6"

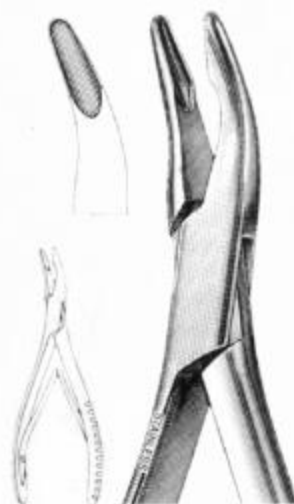

**2755**  
No. 1A-MEAD  
6 1/2"

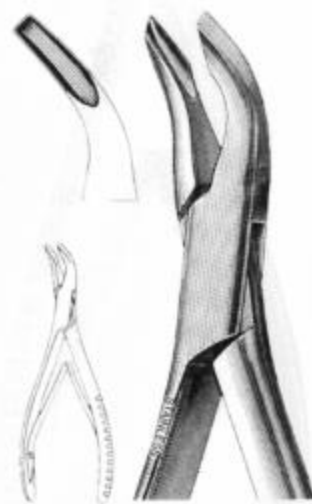

**2756**  
MEAD, Square  
No. 2A  
Tips, 6 1/2"



**2757**

# RONGEURS



**2757**  
FRIEDMAN  
5 1/2"

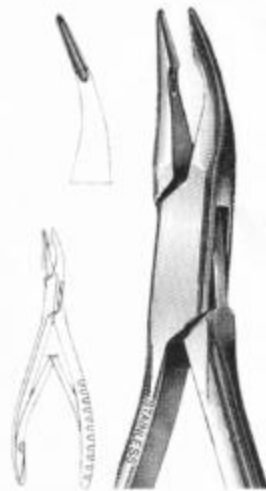

**2758**  
MICRO-FRIEDMAN  
5 1/2", 15° Curved Jaws

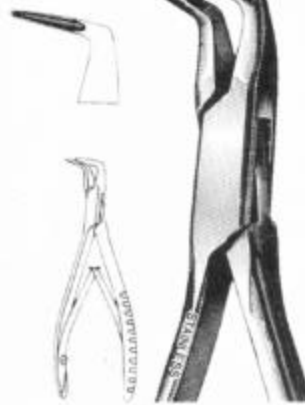

**2759**  
MICRO-FRIEDMAN  
Perio Rongeur, 5 1/2"

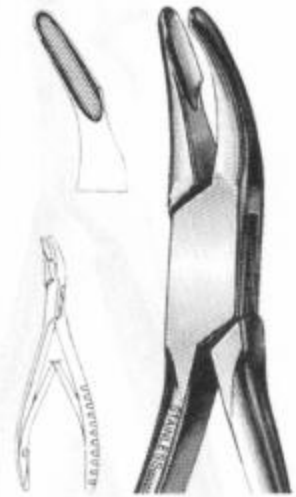

**2760**  
CLEVELAND  
No. 4 - 5 1/2"

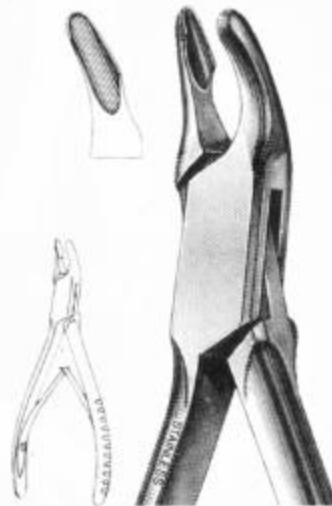

**2761**  
CLEVELAND  
No. 4A - 6 1/2"

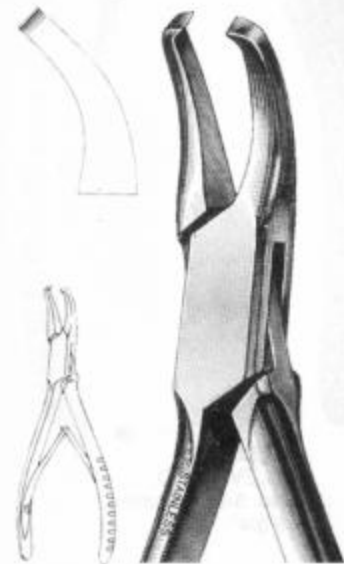

**2762**  
GARDNER  
No. 6A, End Cutting  
6 1/2"

# RONGEURS

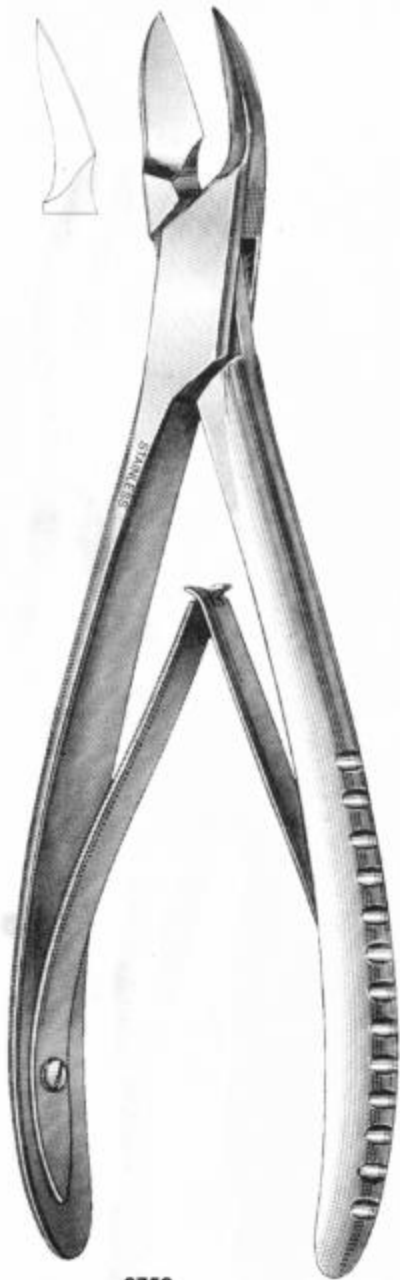

**2752**  
CLEVELAND  
No. 5-Side Cutting,  
6 3/4"

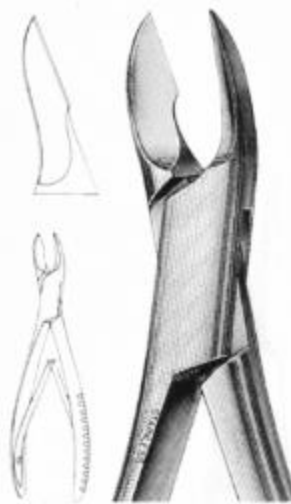

**2753**  
CLEVELAND  
No. 5A-Side Cutting,  
6 1/2"

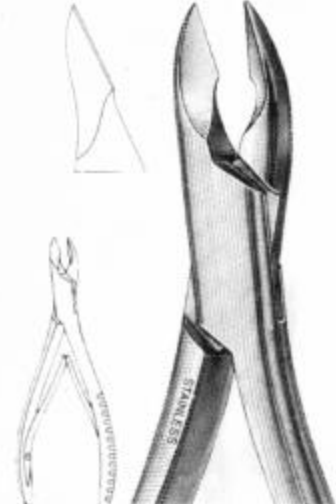

**2754**  
CLEVELAND  
No. 5S-Side Cutting,  
6"

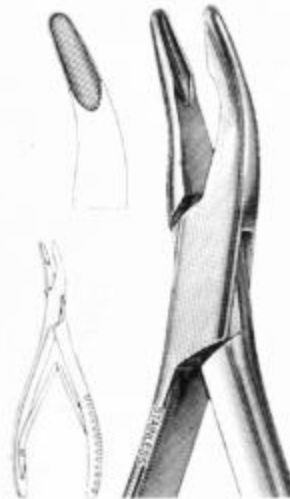

**2755**  
No. 1A-MEAD  
6 1/2"

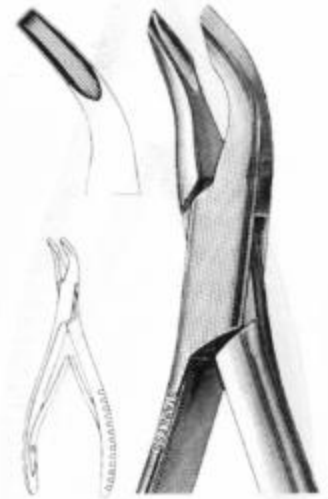

**2756**  
MEAD, Square  
No. 2A  
Tips, 6 1/2"



**2757**

# RONGEURS



**2757**  
FRIEDMAN  
5 1/2"

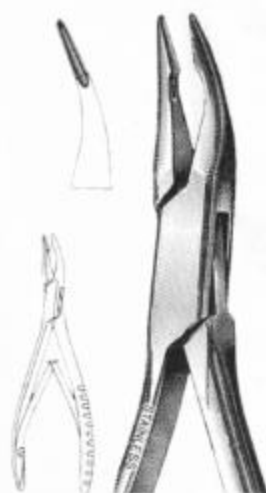

**2758**  
MICRO-FRIEDMAN  
5 1/2", 15° Curved Jaws

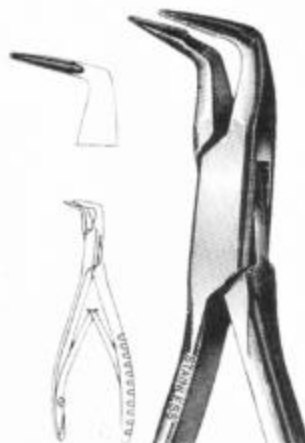

**2759**  
MICRO-FRIEDMAN  
Perio Rongeur, 5 1/2"

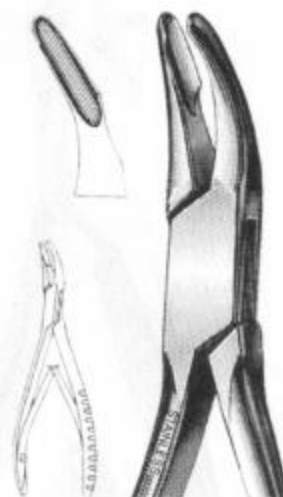

**2760**  
CLEVELAND  
No. 4 - 5 1/2"

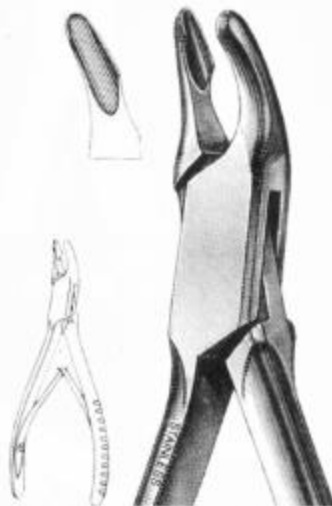

**2761**  
CLEVELAND  
No. 4A - 6 1/2"

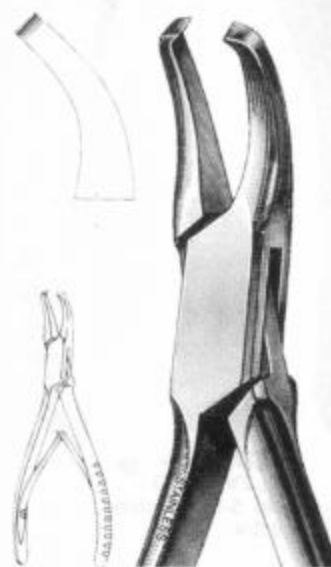

**2762**  
GARDNER  
No. 6A, End Cutting  
6 1/2"

# RONGEURS



**2763**  
BEYER  
Double Action,  
16,18 cm

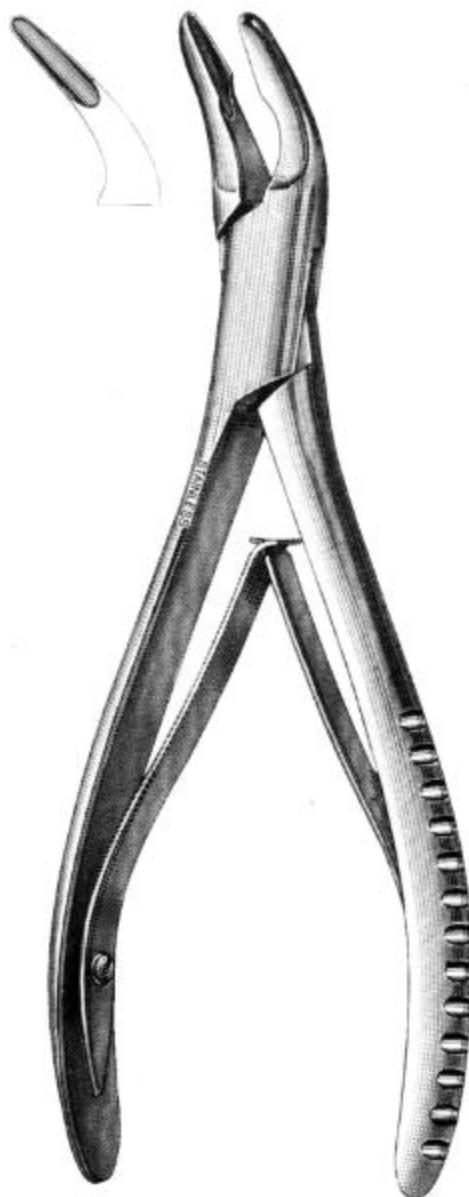

**2764**  
No. 1  
6 1/2"

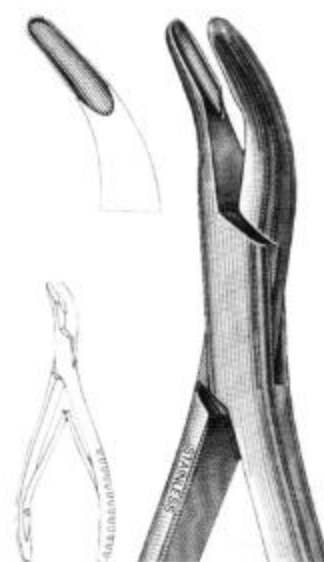

**2765**  
HARTMAN  
5 3/4"  
Strong Curve

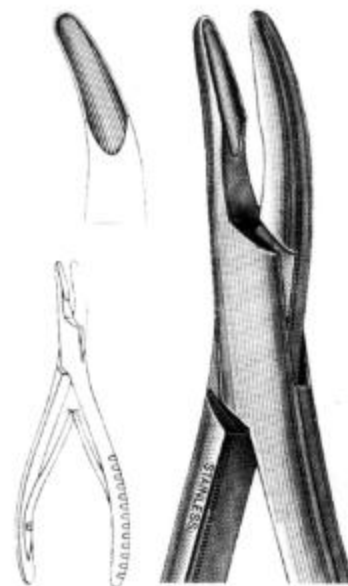

**2766**  
BANE  
Slight Curve  
7"

## NEEDLE HOLDERS



**2767**  
COLLIER  
5", Fenestrated Jaws



**2768**  
DERF  
4 3/4"



**2769**  
WEBSTER  
Delicate Smooth Jaws  
5"



**2770**  
NEIVERT  
One Offset Ring  
5"



**2771**  
OLSEN-HEGAR  
5 1/2"



**2772**  
BAUMGARTNER  
5 1/2"

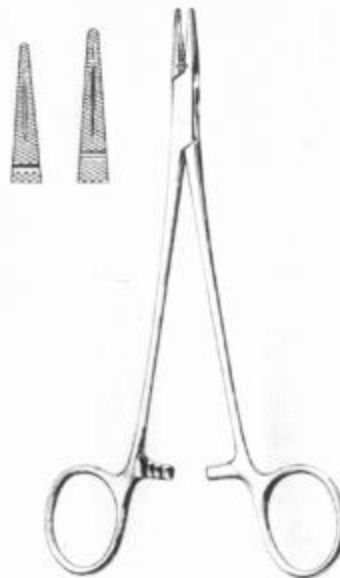

**2773**  
CRILE-WOOD  
6"



**2774**  
GARDNER  
5"

# NEEDLE HOLDERS



**2775**  
MAYO-HEGAR  
5"



**2776**  
CASTROVIEJO  
Smooth Jaws  
14 cm



**2777**  
CASTROVIEJO  
Smooth Jaws  
14 cm



**2778**  
CASTROVIEJO  
Smooth Jaws  
14 cm



**2778**  
CASTROVIEJO  
Smooth Jaws  
14 cm



**2779 A**  
18 cm



**2780 A**  
18 cm



**2781**  
BOYNTON  
5"



**2782**  
CRILE  
6"



**2783**  
MATHIEU  
5 1/2"



**2784**  
STEVENS  
6 1/2"

# MICRO SURGERY SET



**2785**  
Micro Scissor  
Straight, 155 mm



**2786**  
Micro Scissor  
Straight, 150 mm



**2787**  
Micro Scissor  
Curved, 150 mm



**2788**  
Micro Scissor  
Curved, 155 mm



**2789**  
CASTROVIEJO  
T.C.  
Straight, 180 mm



**2790**  
Retractor  
Fig.3  
165 mm



**2791**  
Micro Adson  
120 mm



**2792**  
GERALD  
Curved,  
180 mm



**2793**  
GERALD  
Straight,  
175 mm



**2794**  
Micro Adson  
160 mm



**2795**  
Micro Surgery Set 10 Pieces.



# SCISSORS



**2796**  
IRIS (Standard)  
Straight  
11.5 cm, 4 1/2"



**2797**  
IRIS (Standard)  
Curved  
11.5 cm, 4 1/2"



**2798**  
STEVENS  
Dissecting Scissors  
Size: 115 mm



**2799**  
Sharp



**2800**  
Sharp



**2801**  
Blunt



**2802**  
Blunt



**2803**



**2804**  
JOSEPH  
Size: 150 mm

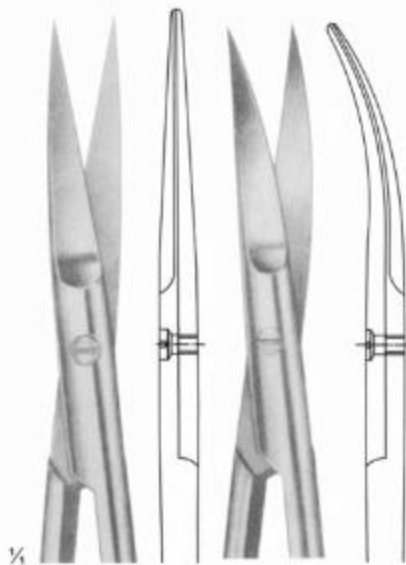

**2808**  
KELLY  
Straight

**2805**

**2806**

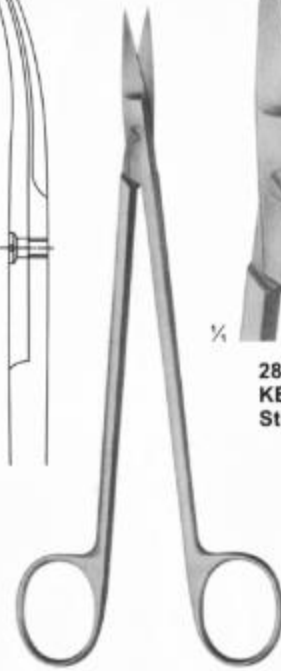

**2809**  
KELLY  
Curved

**2807**  
KELLY  
Size: 175 mm

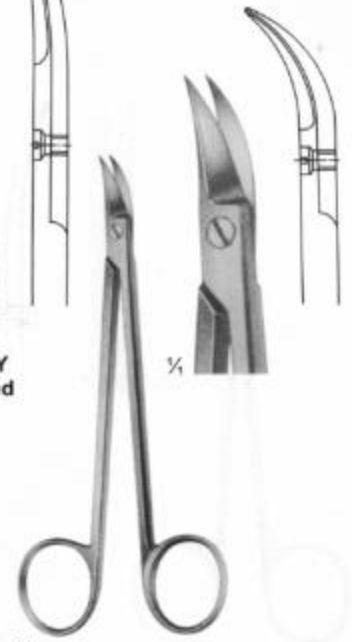

**2810**  
QUINBY  
Size: 130 mm

# SCISSORS

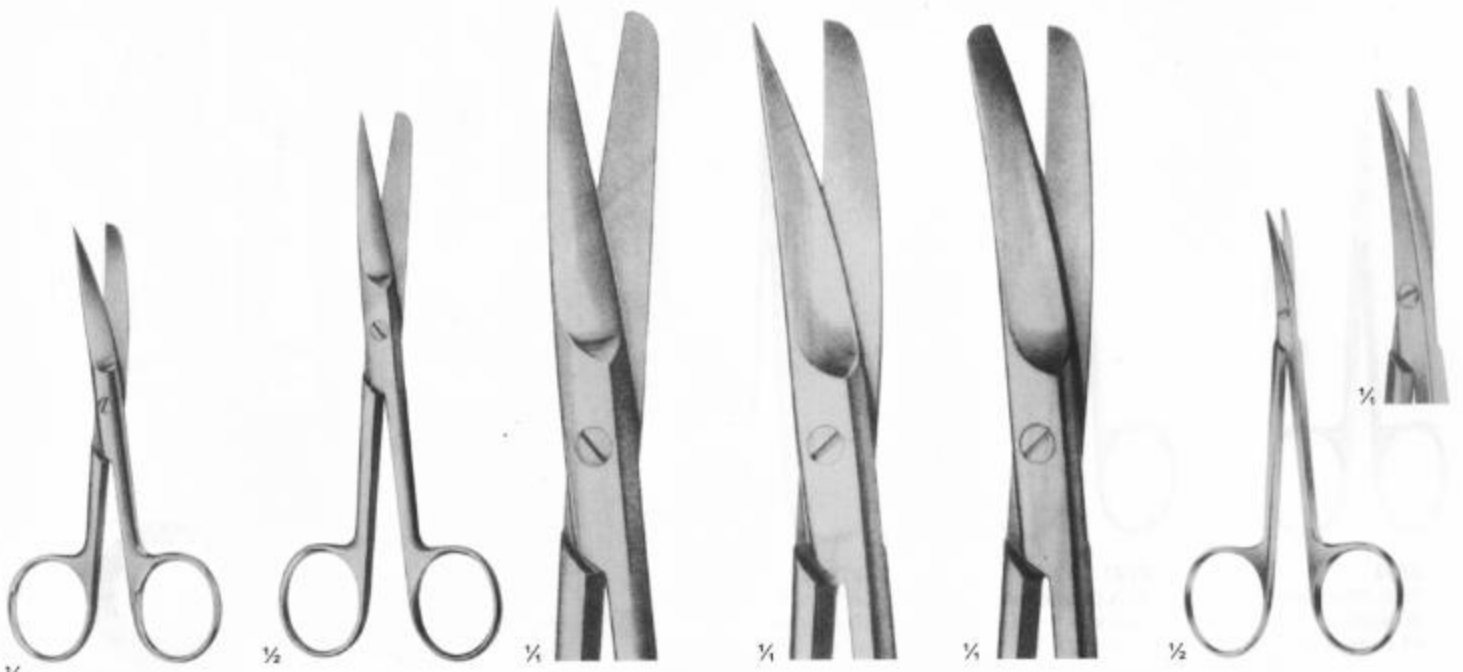

**2811**  
Standard - Types  
Size: 115 mm

**2812**  
DEAVER  
With flat lock

**2813**  
Size: 145 mm

**2814**  
Size: 145 mm

**2815**  
Size: 145 mm

**2816**  
LITTLER  
Dissecting Scissors  
Size: 115 mm

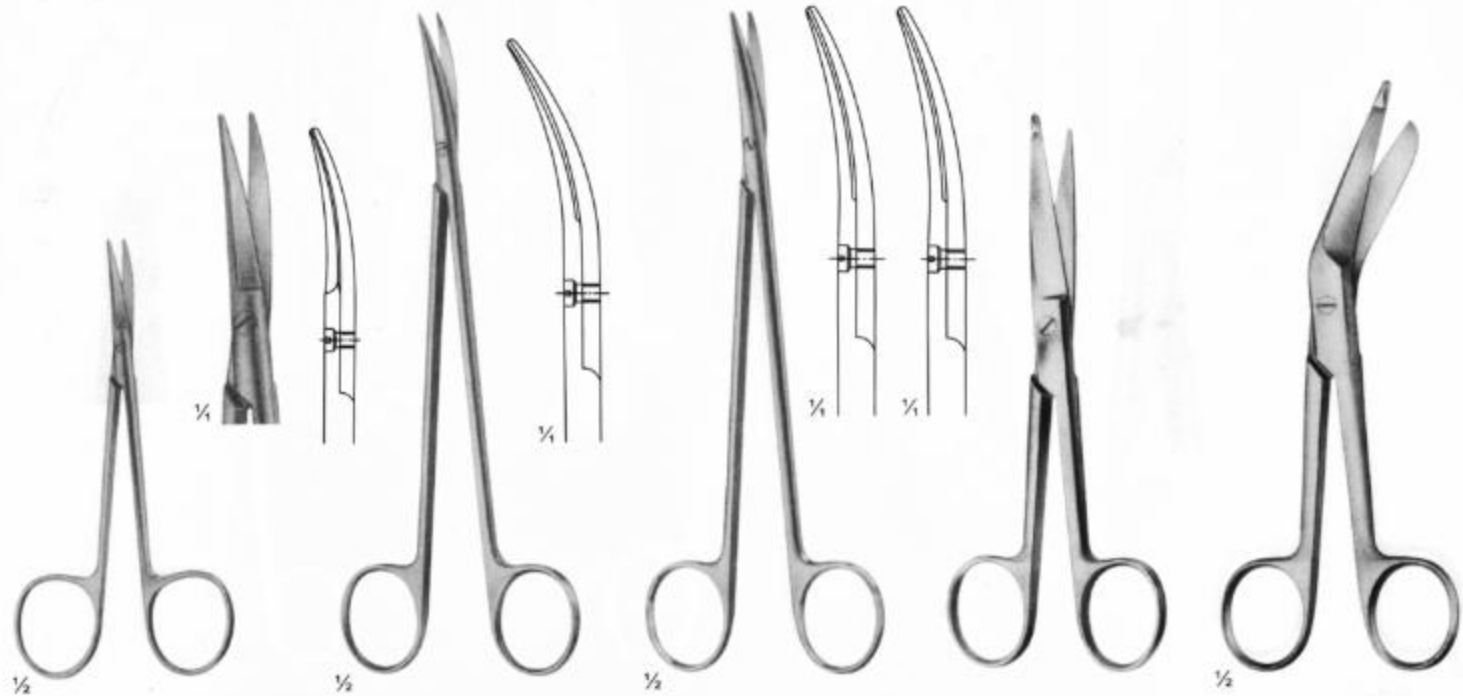

**2817**  
COTTLE  
Bulldog Scissors  
Size: 115 mm

**2818**  
DE BAKEY  
Ateriotomy scissors  
Size: 175 mm

**2819**  
TOENNIS - ADSON  
Dissecting scissors  
Size: 175 mm

**2820**  
KNOWLES  
Size: 145 mm

**2821**  
LISTER

# SCISSORS

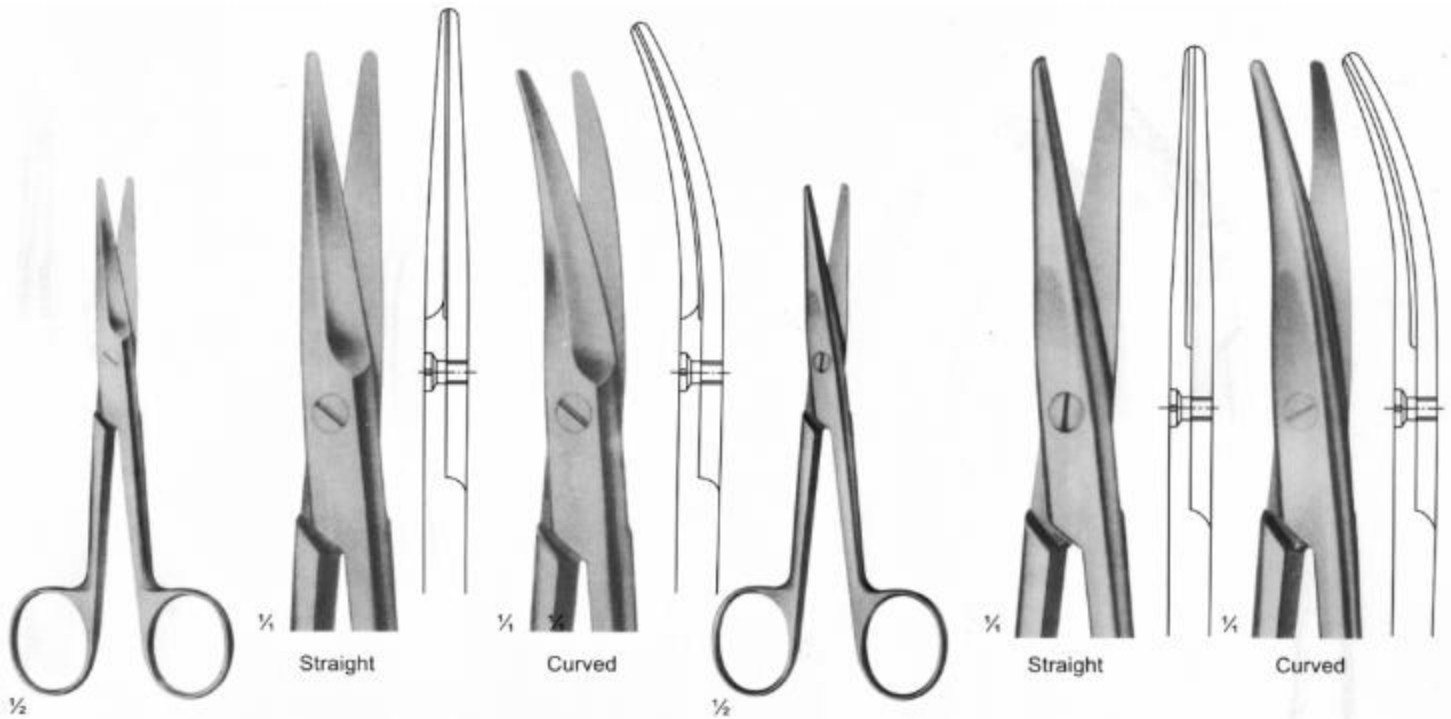

2822  
MAYO(straight)  
Size: 140 mm

2823  
MAYO-STILLE (straight)  
Size: 140 mm



2824

2825

2826

# SCISSORS

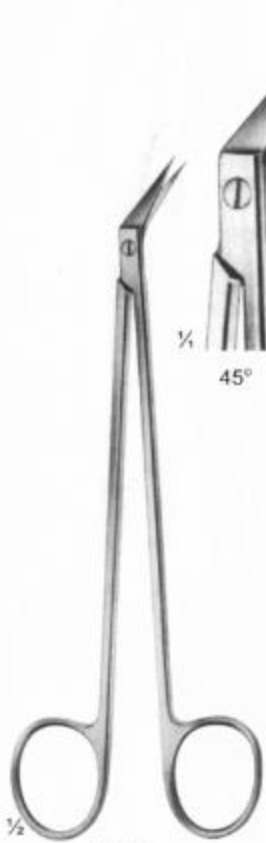

**2827**  
DE BAKEY  
Size: 155 mm

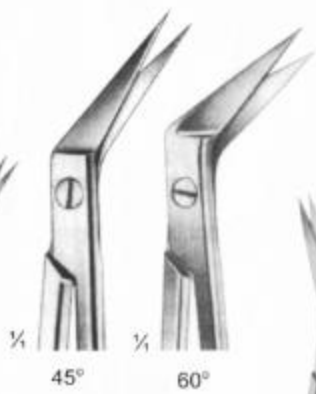

**2828**  
LOCKLIN  
Curved Sideways,  
1 Toothed Blade  
Size: 155 mm



**2829**  
LaGrange  
Double-Curved  
11.5 cm



**2830**  
Goldman-Fox  
Double-Curved  
13cm



**2831**  
SPENCER  
Size: 90 mm

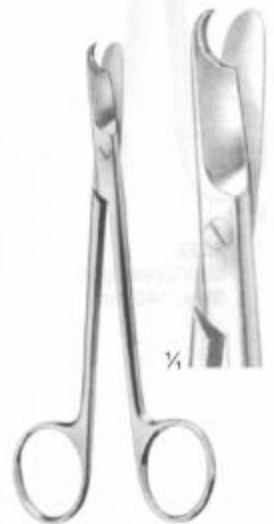

**2832**  
LITTAUER  
Size: 135 mm

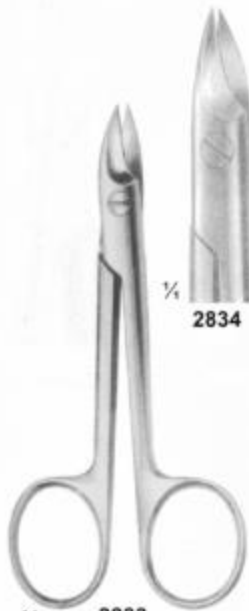

**2833**  
BEEBE  
Size: 110 mm

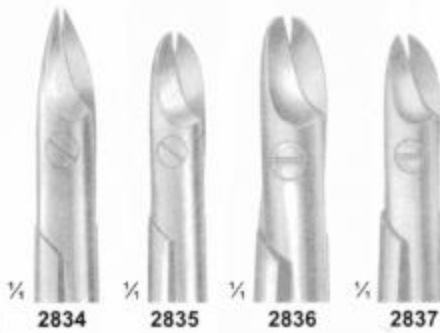

**2834**   **2835**   **2836**   **2837**



**2838**

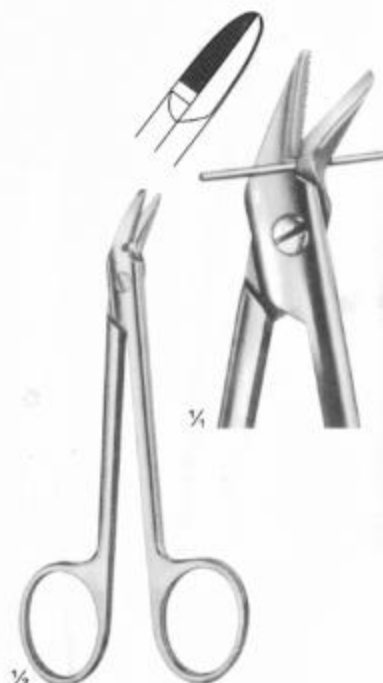

**2839**  
1 Blade Serrated  
Size: 120 mm



**2840**  
CASTROVIEJO  
Size: 90 mm

# IMPRESSION TRAYS

Made of 18/8 Stainless Steel, Solid, Set of 10

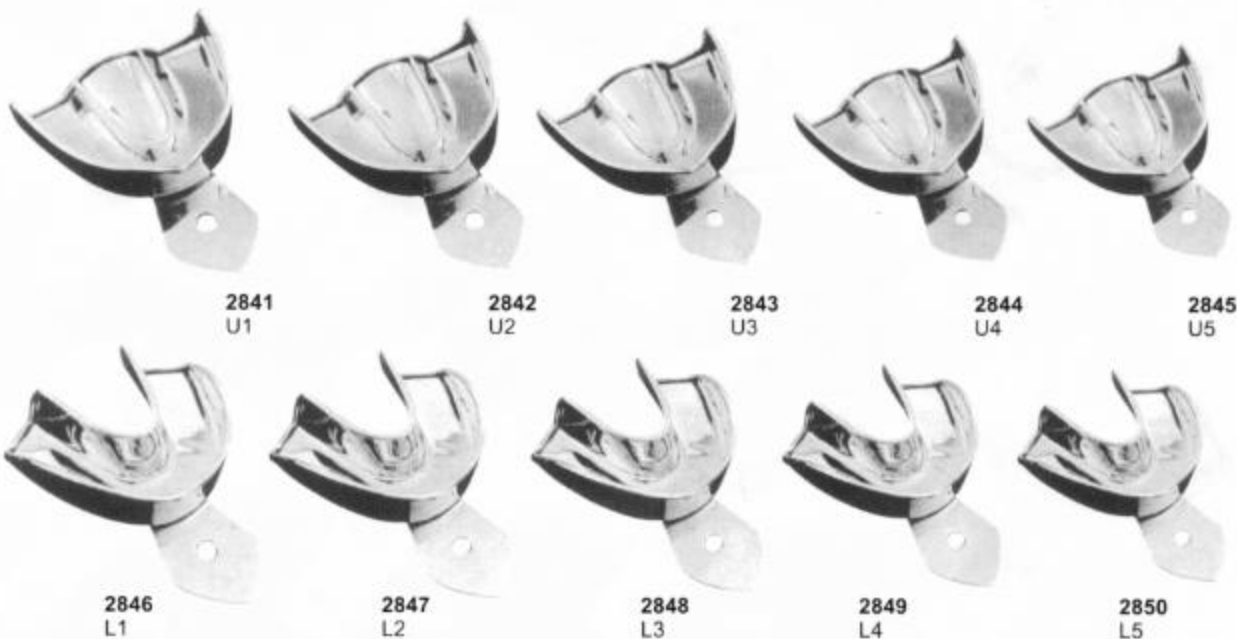

All The Above Impression Trays are Available in These 5 Sizes

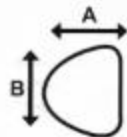

UPPER	U1	U2	U3	U4	U5
	A	62	60	53	54
B	83	75	73	69	68

All Dimension are in mm

LOWER	L1	L2	L3	L4	L5
	A	63	61	57	60
B	82	81	78	74	71

All Dimension are in mm

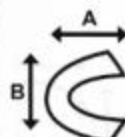

Perforated, Set of 10

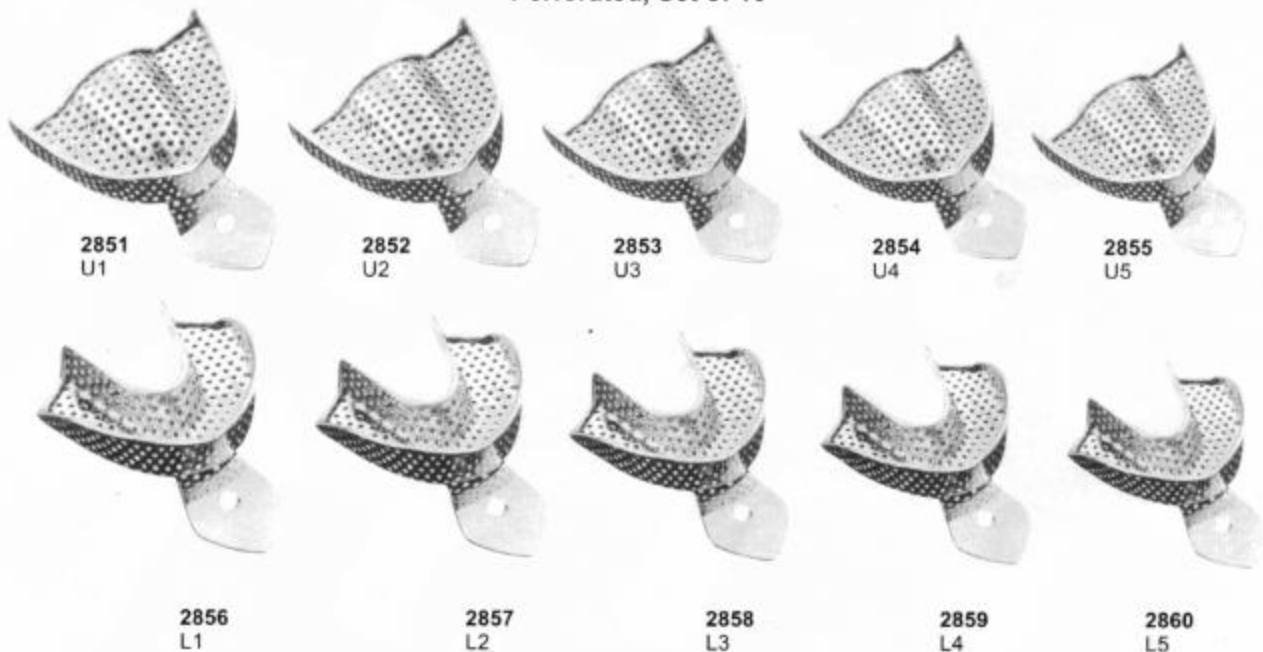

# IMPRESSION TRAYS

Made of 18/8 Stainless Steel, Solid Full Denture Set of 8

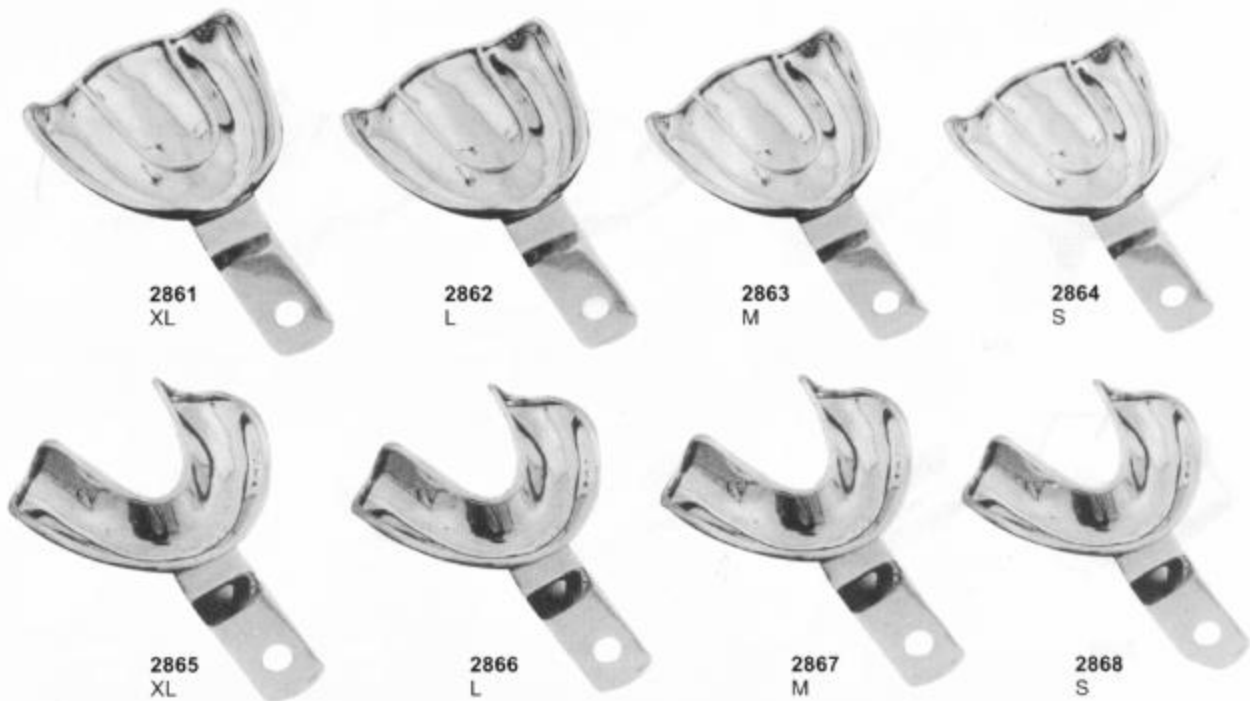

All The Above Impression Trays are Available in These 4 Sizes

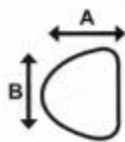

UPPER		XL	L	M	S
	A	70	67	64	60
B	79	76	70	73	

All Dimension are in mm

LOWER		XL	L	M	S
	A	64	64	60	57
B	86	70	73	70	

All Dimension are in mm

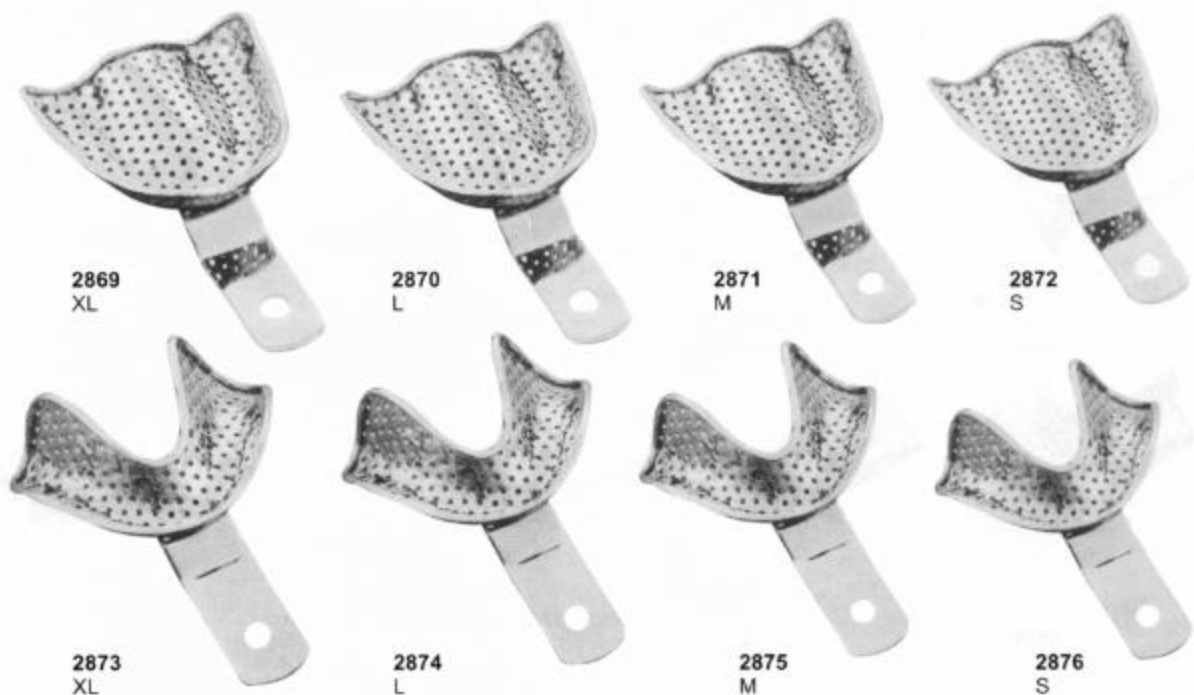
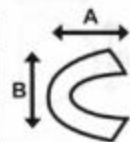

Perforated Full Denture Set of 8

# IMPRESSION TRAYS

Made of 18/8 Stainless Steel, Solid Set of 6

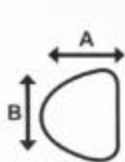
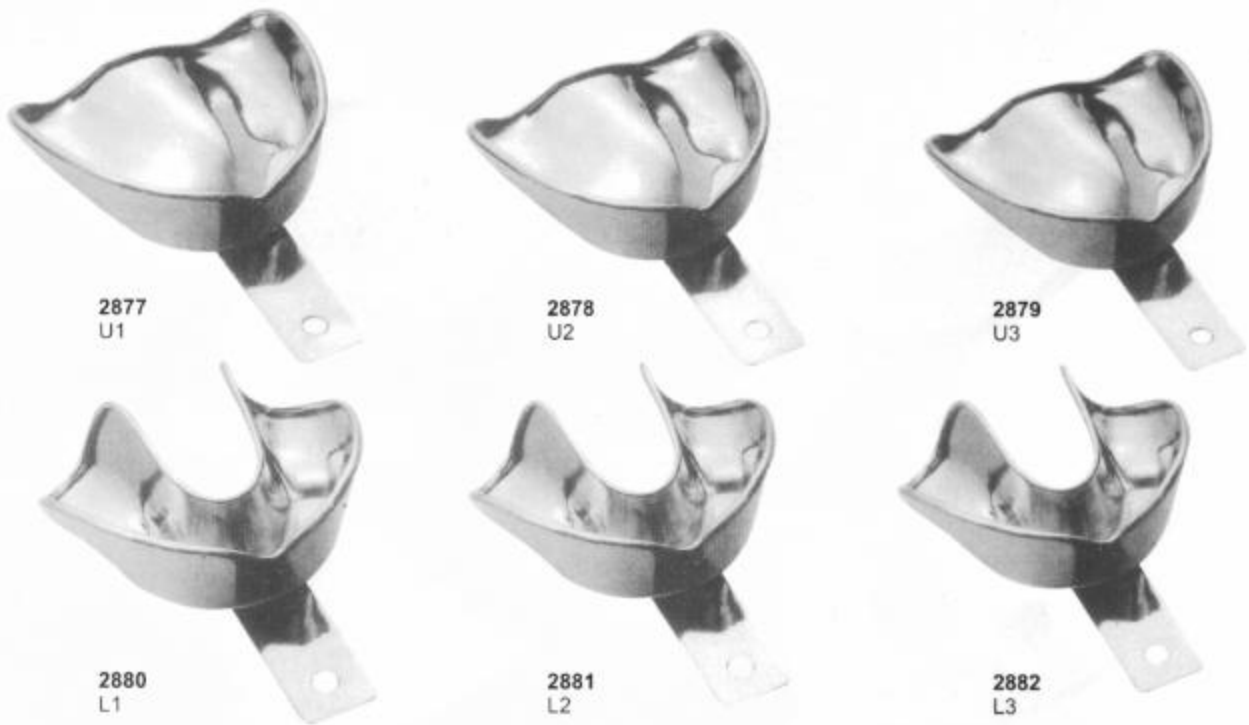

All The Above Impression Trays are Available in These 4 Sizes

UPPER		U1	U2	U3
	A		67	64
B		81	71	70

All Dimension are in mm

LOWER		L1	L2	L3
	A		60	57
B		81	79	76

All Dimension are in mm

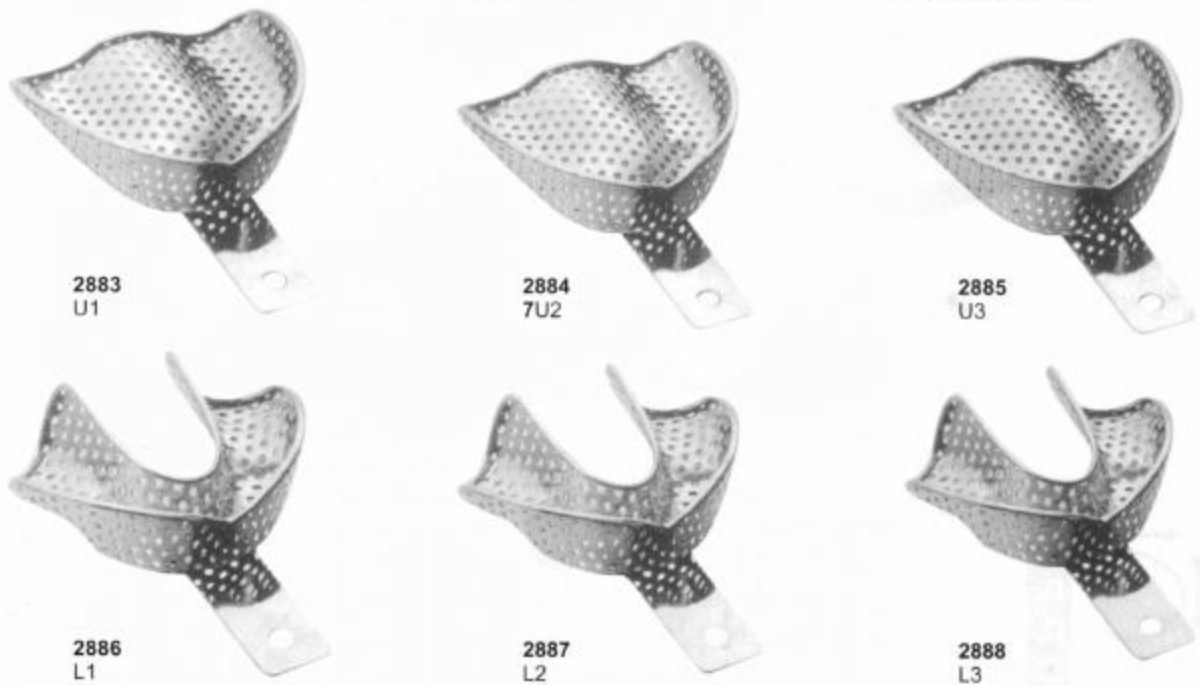
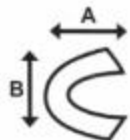

Perforated Set of 6

# IMPRESSION TRAYS

Made of 18/8 Stainless Steel, English Pattern Set of 8



2889  
Lower



2890  
Upper

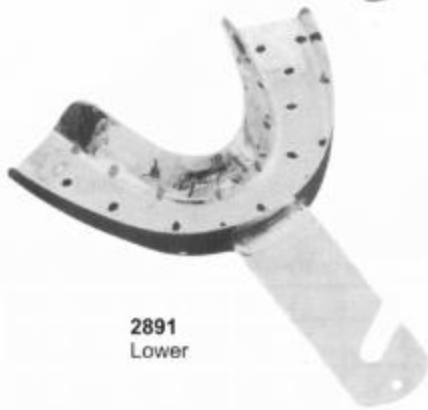

2891  
Lower



2892  
Upper



2893  
Lower



2894  
Upper

All The Above Impression Trays are Available in These 4 Sizes

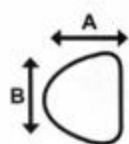

UPPER	Size	A	B	C
	0	67	50	12
	1	72	51	13
	2	78	55	15
	3	80	58	15

All Dimension are in mm

LOWER	Size	A	B	C
	0	70	50	14
	1	77	51	15
	2	79	55	15
	3	80	60	17

All Dimension are in mm

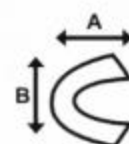



# IMPRESSION TRAYS

Made of 18/8 Stainless Steel, Solid Full Denture Set of 8

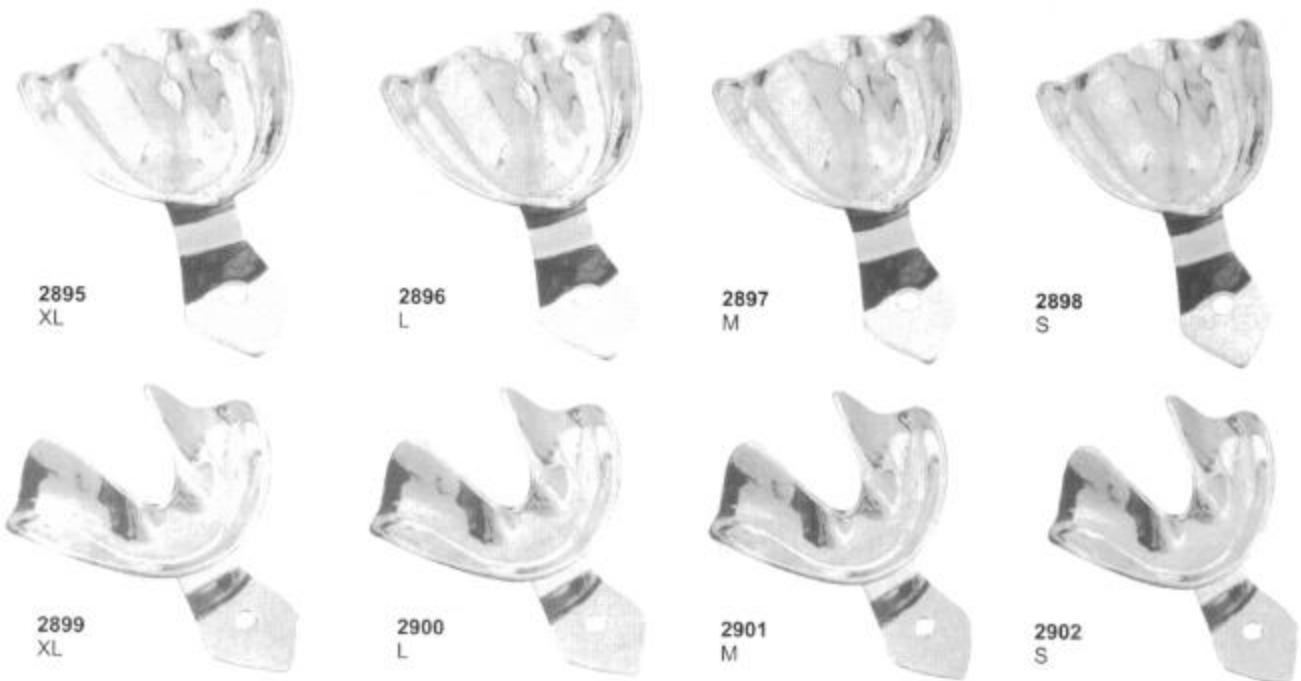

All The Above Impression Trays are Available in These 4 Sizes

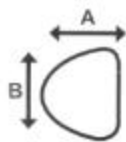

UPPER		XL	L	M	S
	A	70	67	64	60
B	79	76	70	73	

All Dimension are in mm

LOWER		XL	L	M	S
	A	64	64	60	57
B	86	70	73	70	

All Dimension are in mm

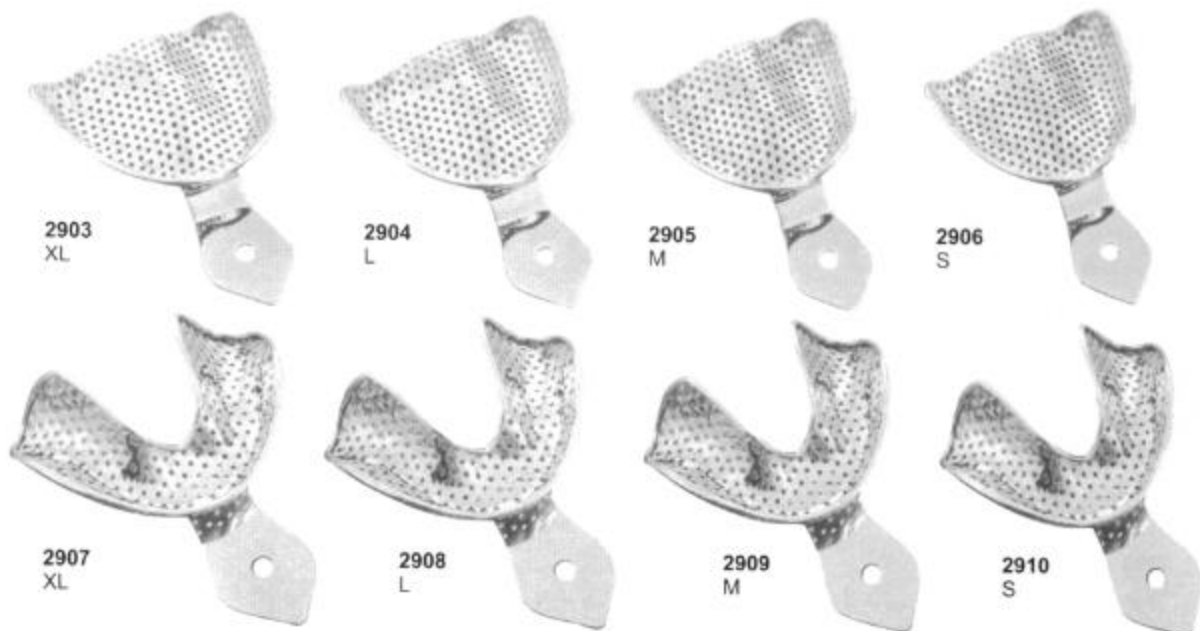
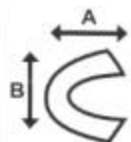

Made of 18/8 Stainless Steel, Perforated Full Denture Set of 8

# IMPRESSION TRAYS

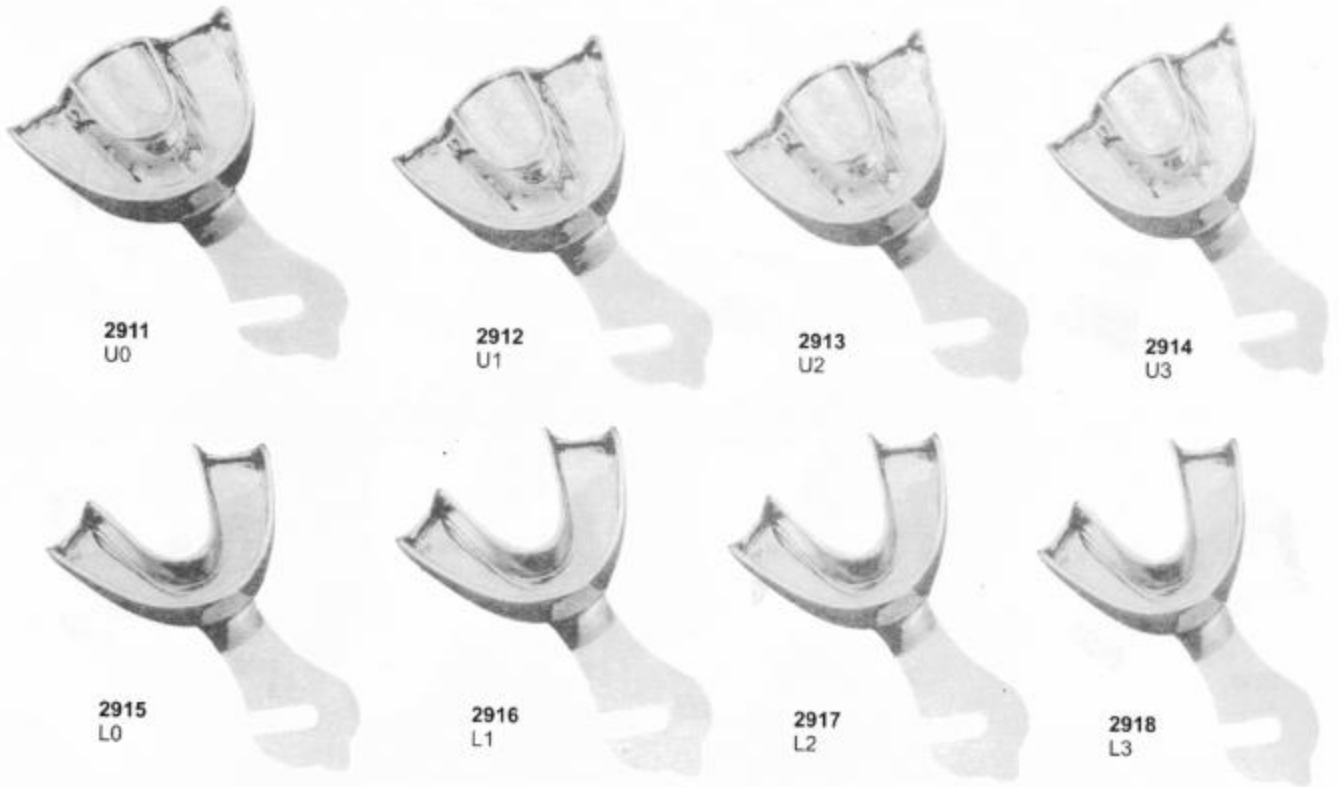

2911  
U0

2912  
U1

2913  
U2

2914  
U3

2915  
L0

2916  
L1

2917  
L2

2918  
L3

Upper Sizes: 0,1,2,3

Depth of Tray: 15,9 mm, Height of Plate: 12,5 mm

Lower Sizes: 0,1,2,3

Depth of Tray: 12,9 mm

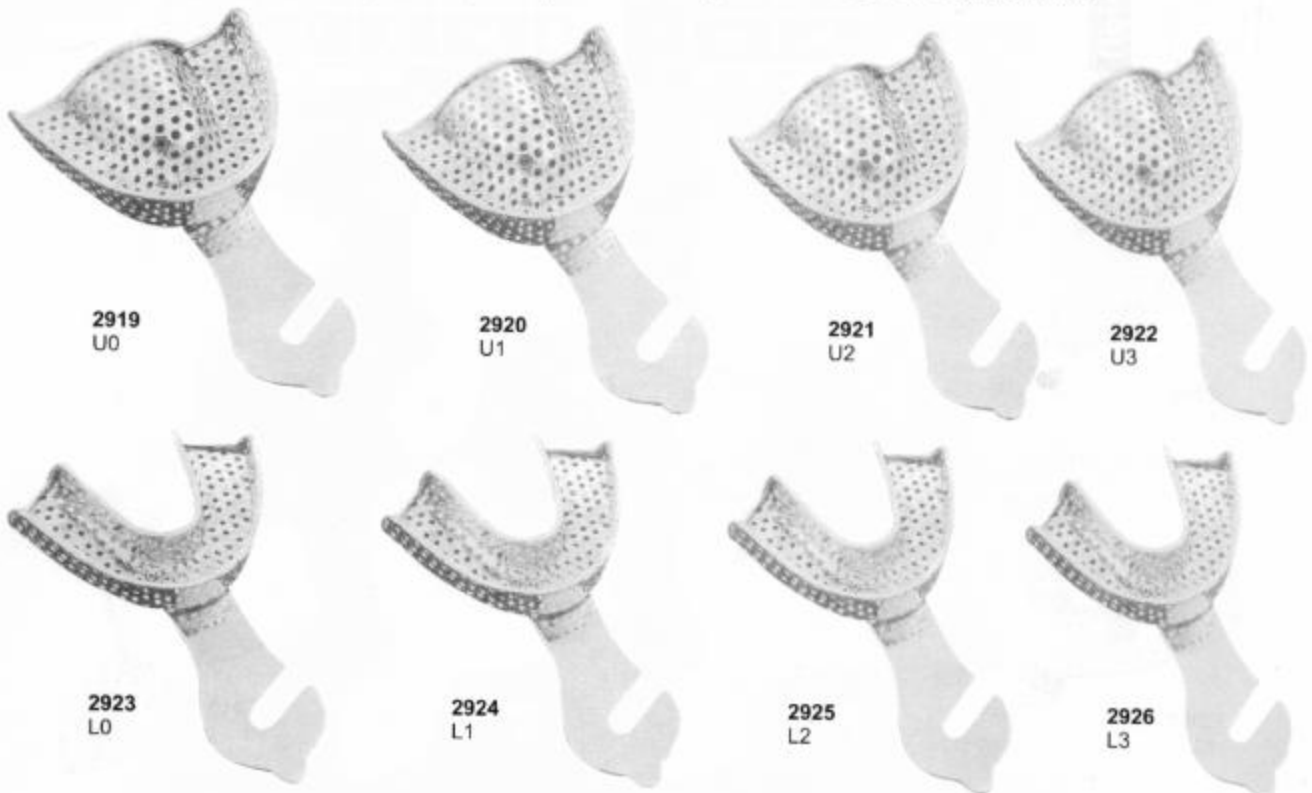

2919  
U0

2920  
U1

2921  
U2

2922  
U3

2923  
L0

2924  
L1

2925  
L2

2926  
L3

Made of 18/8 Stainless Steel, Perforated Full Denture Set of 8

# IMPRESSION TRAYS

## Impression Trays For Crown & Bridge Work

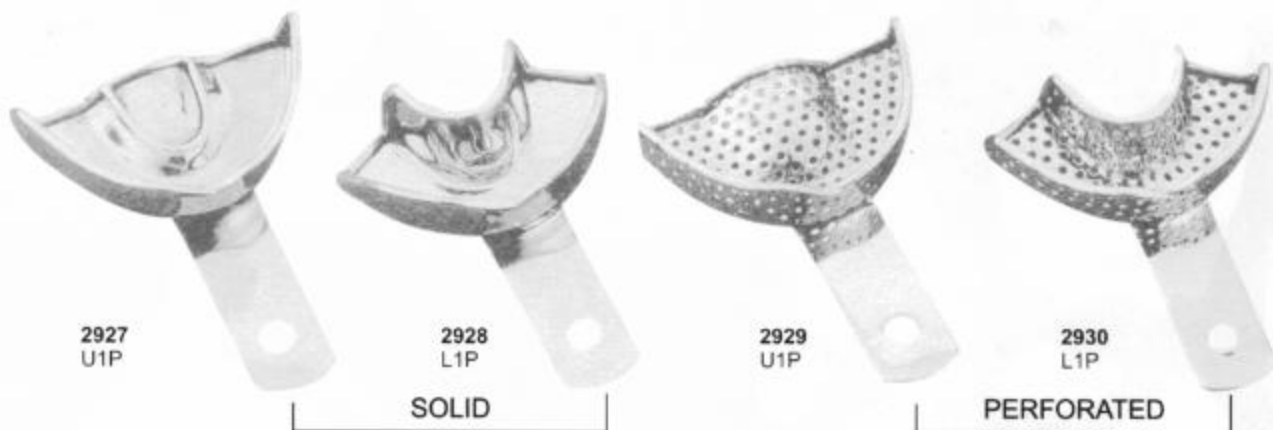

2927  
U1P

2928  
L1P

2929  
U1P

2930  
L1P

SOLID

PERFORATED



2932  
Adjustable  
Perforated



2933  
Adjustable  
Solid

PERFORATED

SOLID



2931-A  
For upper right jaw  
For lower left jaw

2931-B  
For upper left jaw  
For lower right jaw



2931-C  
For upper right jaw  
For lower left jaw

2931-D  
For upper left jaw  
For lower right jaw

**Available in 4 sizes**

- 1.....44 mm
- 2.....55 mm
- 3.....60 mm
- 4.....65 mm

**Available in 4 sizes**

- 1.....44 mm
- 2.....55 mm
- 3.....60 mm
- 4.....65 mm

# ARTICULATORS

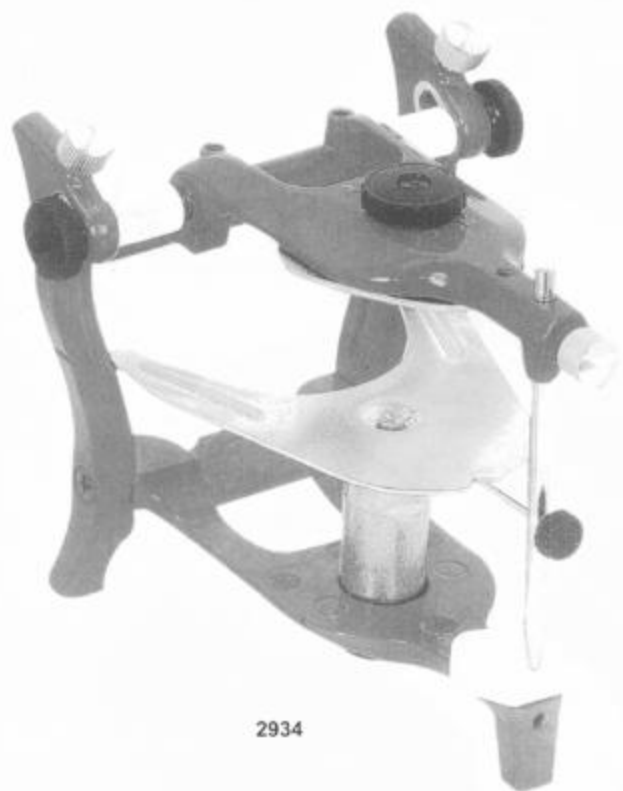

2934



2935

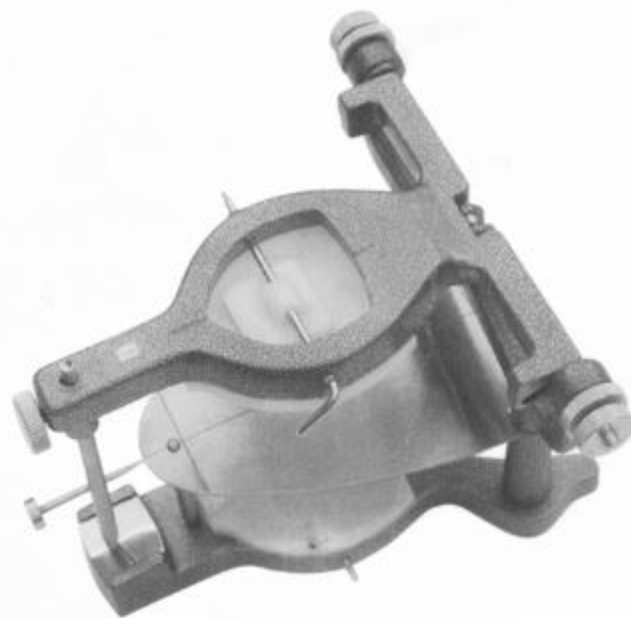

2936



2937



2939

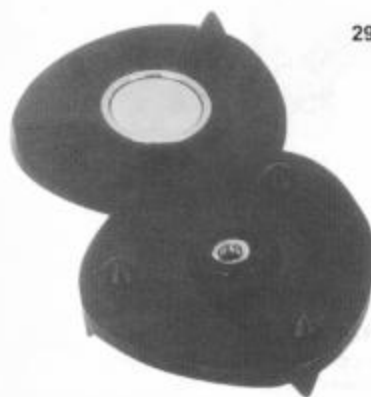

2938

## ARTICULATORS



2940



2941



2942



2943



2944



2945



2946



2947

## HOLLOW WARES



**2948**  
Instruments Tray of 20 Pcs



**2951**  
Instruments Riddle



**2949**  
Instruments Tray of 7 Pcs



**2949-A**  
Instruments Tray of 10 Pcs



**2950**  
Instruments Tray of 5 Pcs

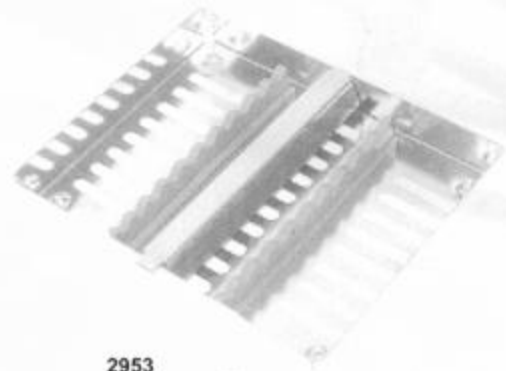

**2953**  
Instruments Tray

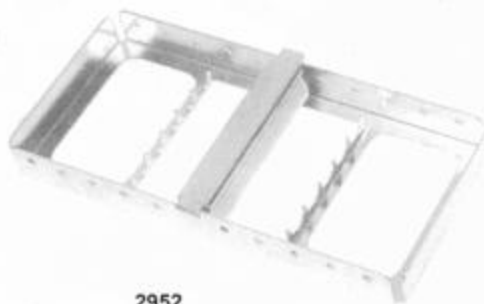

**2952**  
Instruments Tray of 5 Pcs



**2954**  
Instruments Tray  
Perforated



**2955**  
Instruments Tray  
Perforated Base



**2956**  
Instruments Tray  
Solid Base

## HOLLOW WARES

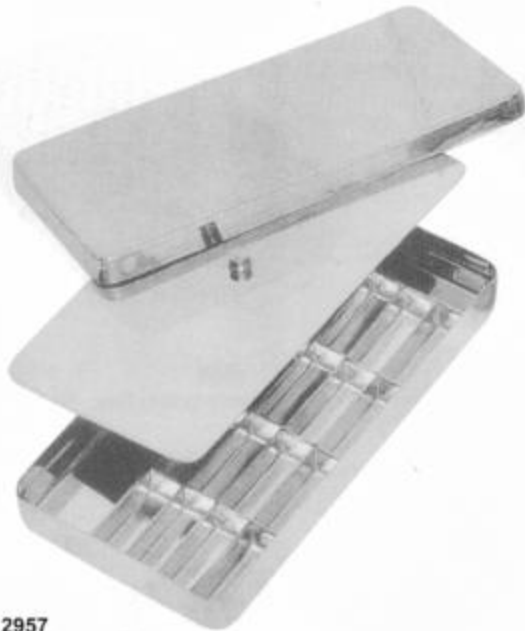

**2957**  
Pulpectomy Tray



**2958**  
Sterilizing Box  
Available Sizes:  
17x17x3 cm  
20x10x6 cm  
30x14x6 cm



**2959**  
Endo Tray Box



**2960**  
Finger Cup



**2961**  
Bur Box

**2962**  
Sterilizing Drum  
150x150mm  
175x175mm  
190x190mm  
200x140mm  
200x200mm  
240x120mm  
225x225mm  
240x240mm  
290x160mm



**2963**  
Sterilizing Drum  
280x240mm  
230x150mm  
300x250mm  
340x160mm  
350x250mm  
390x200mm  
380x300mm  
100x100mm  
150x120mm

## STERILIZING BOXES

### & INSTRUMENT TRAYS



**2964**  
Instruments Box



**2965**  
Instruments Box



**2966**  
Instruments Box



**2967**  
Instruments Sterilizer  
150x75 mm



**2968**  
Endodontic Box



**2969**  
Sterilizing Box  
320x120 mm



**2970**  
Instruments Tray



**2971**  
Instruments Tray



**2972**  
Instruments Tray  
(Perforated)



**2973**  
Instruments Tray  
Shallow(Mayo)



**2974**  
Scaler Tray  
20.0 x 10.0 x 1.5 cm



**2975**  
Scalers Tray



**2976**  
Scalers Tray



## HOLLOW WARES



# HOLLOW WARES



**2989**  
Sponge Bowl



**2990**  
Wash Basin  
300mm-350mm-400mm



**2994**  
Kick Bucket With Trolley



**2991**  
Sponge Bowl



**2992**  
Gallipot



**2993**  
Medicine Cup



**2995**  
Kidney Tray Shallow  
150mm-200mm-240mm-300mm



**2996**  
Kidney Tray Without Lid  
150mm-200mm-250mm-300mm



**2997**  
Kidney Tray With Lid  
150mm-200mm-250mm-300mm



**2998**  
Tube Rack, Stainless Steel 18/10



**2999**  
Needle Case Rectangle  
Needle Case Round With Cover  
90x15



**3000**  
Dustbin Without Stand  
6-10-12 Ltr



**3001**  
Tube Rack, Round Model  
Stainless Steel 18/10



**3002**  
Dustbin Without Stand & Cap  
6-10-12 Ltr



**3003**  
Lotion Bowl With Lip  
40-60-80-100-120-150-180-200mm

## SCISSORS WITH

## TUNGSTEN CARBIDE INSERTS



**3004**  
Standard



14,5cm  
16,5cm  
18,5cm



**3005**  
Standard



14,5cm  
16,5cm  
18,5cm



**3006**  
Standard



14,5cm  
16,5cm  
18,5cm



**3007**  
Standard



14,5cm  
16,5cm  
18,5cm



**3008**  
Standard



14,5cm  
16,5cm  
18,5cm



**3009**  
Standard



14,5cm  
16,5cm  
18,5cm

## SCISSORS WITH

### TUNGSTEN CARBIDE INSERTS



**3010**  
MAYO-LEXER  
Straight  
16 cm

**3011**  
MAYO-LEXER  
Curved  
16 cm

**3012**  
LEXER  
Straight  
16, 21 cm



**3013**  
LEXER  
Curved  
16, 21 cm

**3014**  
MAYO-STILLE  
Straight  
15, 17 cm

**3015**  
MAYO-STILLE  
Curved  
15, 17 cm

# SCISSORS WITH

## TUNGSTEN CARBIDE INSERTS



18cm  
20cm  
28cm  
30cm

11,5cm  
14,5cm  
23,5cm  
25,5cm

**3016**  
METZENBAUM  
Straight



11,5cm  
23cm

14,5cm  
25cm

**3017**  
METZENBAUM  
Curved



18cm  
20cm  
28cm  
30cm

**3018**  
METZENBAUM  
Curved



14cm  
23cm

18cm  
25cm

20cm  
28cm

**3019**  
METZENBAUM FINO  
Straight



14cm  
23cm

18cm  
25cm

20cm  
28cm

**3020**  
METZENBAUM FINO  
Curved



14cm  
20cm

18cm  
23cm

**3021**  
METZENBAUM FINO  
Sharp



**3022**  
BRUNS  
235 mm

# SCISSORS WITH

## TUNGSTEN CARBIDE INSERTS



**3023**  
METZENBAUM FINO



**3024**  
METZENBAUM FINO



**3025**  
METZENBAUM FINO



**3026**  
METZENBAUM FINO



**3027**  
MAYO  
Straight



**3028**  
MAYO  
Curved

# SCISSORS WITH

## TUNGSTEN CARBIDE INSERTS



3029  
SIMS

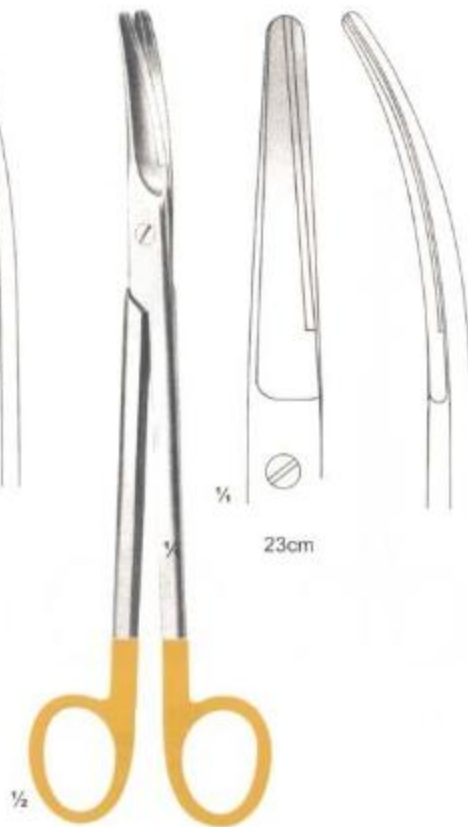

3030  
PARAMETRIUM

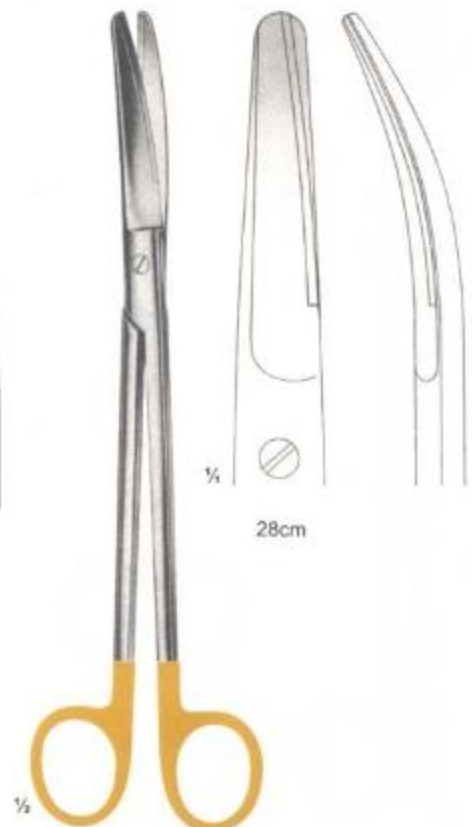
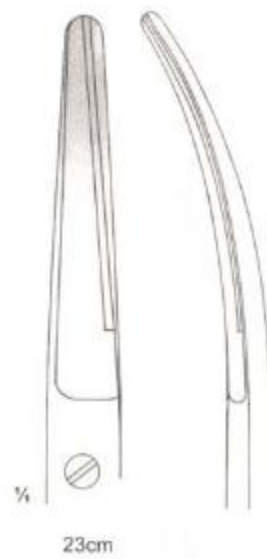

3031  
MAYO-HARRINGTON

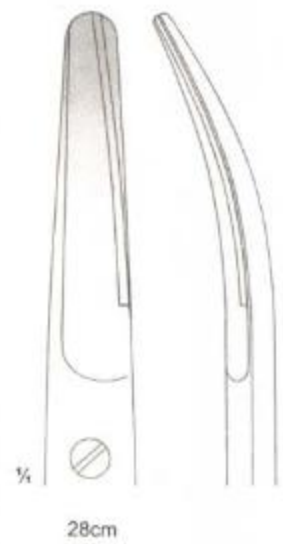

3032  
KELLY  
Straight 16 cm



3033  
KELLY  
Curved 16 cm



3034  
DEAN  
17 cm



3035  
LAGRANGE  
Double-Curved  
11.5 cm

# SCISSORS WITH

## TUNGSTEN CARBIDE INSERTS

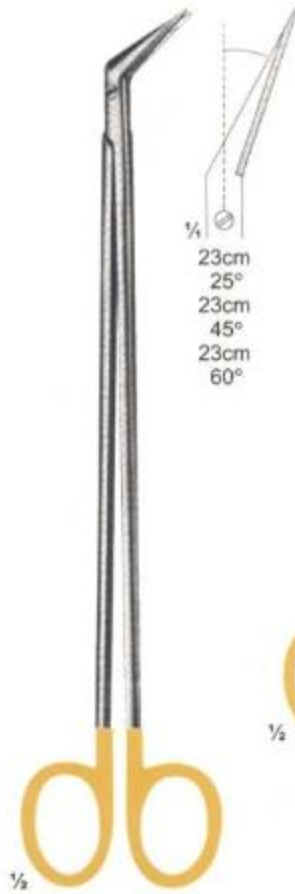

**3036**  
DE-BAKEY



**3037**  
DE-BAKEY

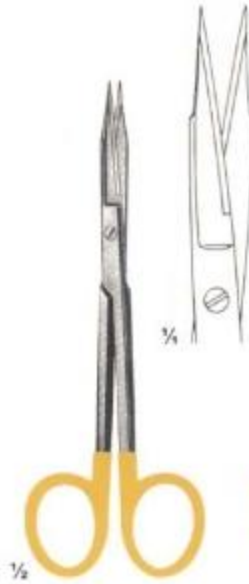

**3038**  
GOLDMAN FOX  
13 cm



**3039**  
GOLDMAN FOX  
Double-Curved  
13 cm

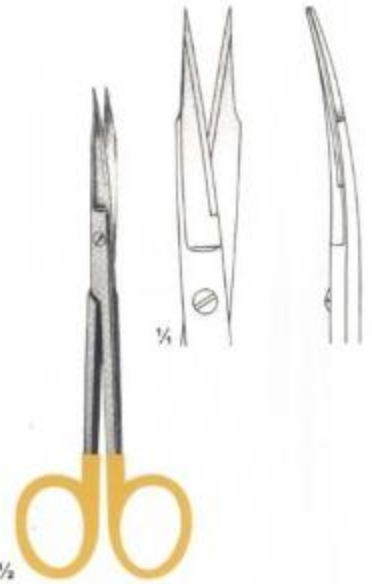

**3040**  
GOLDMAN FOX  
13 cm



**3041**  
Fine Scissors  
Straight  
11, 5 cm



**3042**  
Fine Scissors  
Curved  
11, 5 cm



**3043**  
Fine Scissors  
Angled  
11, 5 cm



**3044**  
RAGNELL  
Curved  
12 cm



# SCISSORS & DISSECTING

## FORCEPS WITH TUNGSTEN CARBIDE INSERTS



# DISSECTING FORCEPS

## & NEEDLE HOLDERS T.C. INSTRUMENTS

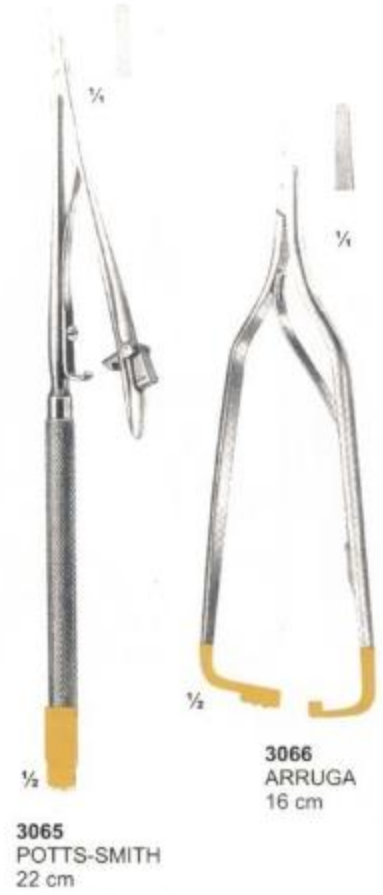
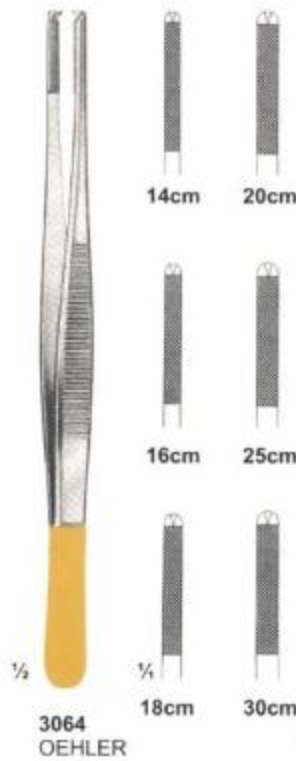
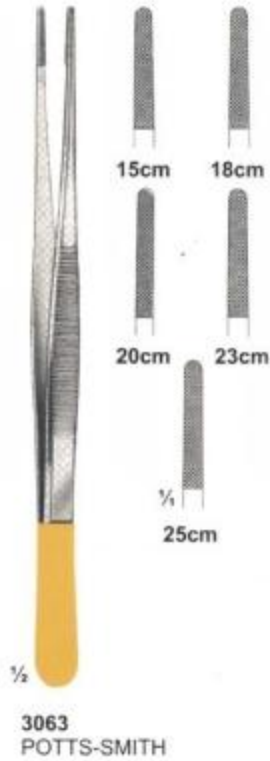

# NEEDLE HOLDERS

## WITH T.C. INSERTS



**3075**  
ARRUGA  
Curved  
16 cm

**3076**  
CASTROVIEJO  
13 cm

**3077**  
HEGAR  
20,24 cm

**3078**  
SMOOTH TIP  
15 cm

**3079**  
HALSEY  
13,15 cm



**3080**  
MAYO-HEGAR

**3081**  
DE BAKEY

**3082**  
HEGAR-VASCULAR

**3083**  
WEBSTER  
125 mm

# NEEDLE HOLDERS

## WITH TUNGSTEN CARBIDE INSERTS

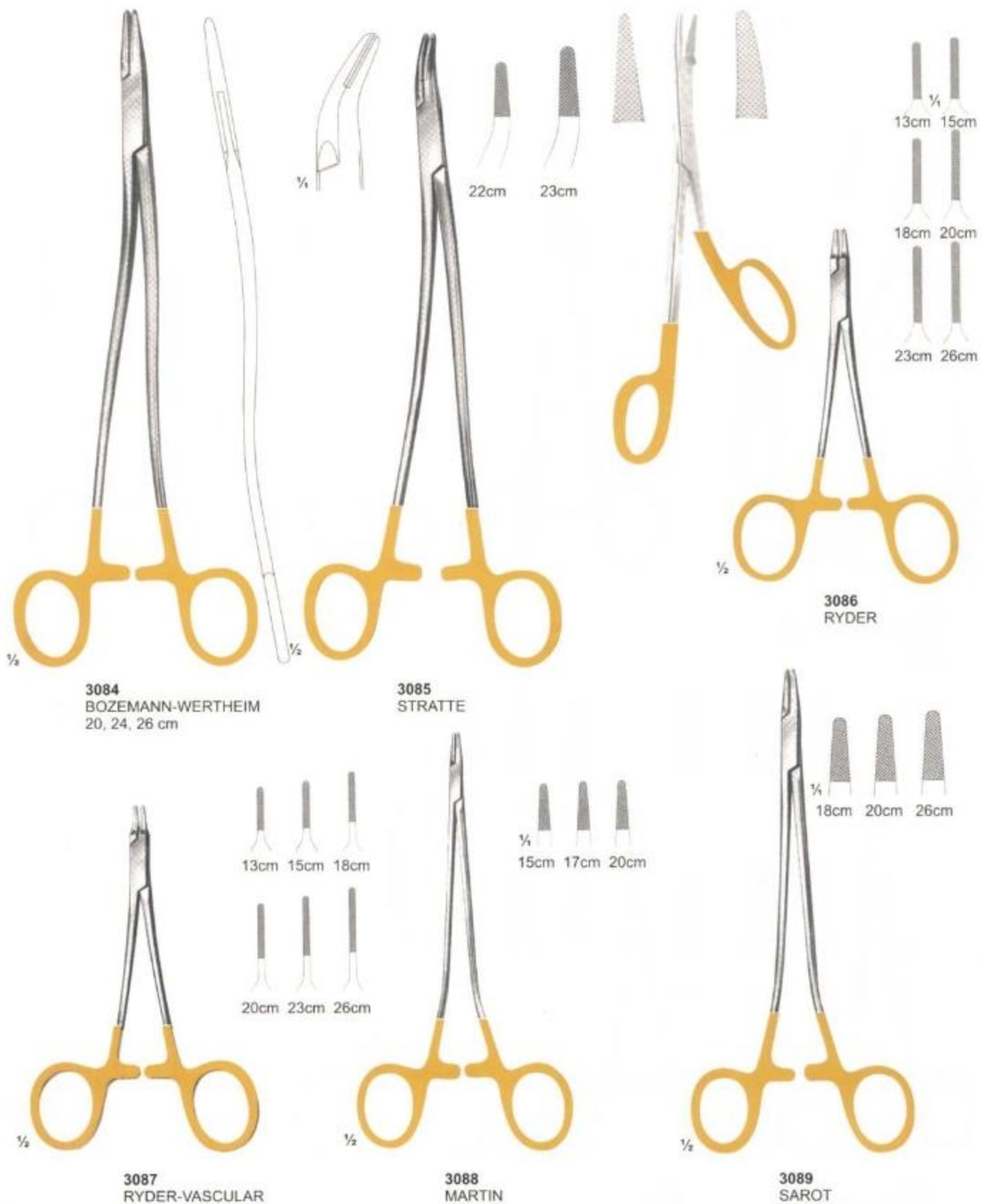

# NEEDLE HOLDERS

## WITH TUNGSTEN CARBIDE INSERTS



# NEEDLE HOLDERS

## WITH T.C. INSERTS



**3100**  
MATHIEU-RYDER  
17,20,24 cm



**3101**  
Hosel  
Curved  
20 cm



**3102**  
LICHTENBERG  
20 cm



**3103**  
LANGHALS  
20,25 cm



**3104**  
LICHTENBERG  
20,25 cm



**3105**  
LUEHTY-BECK  
20,25 cm



**3106**  
LUEHTY-BECK  
20,25 cm



**3107**  
LANGENBECK  
18,20,23 cm



**3108**  
LANGENBECK  
18,20,23 cm

# WIRE CUTTING PLIERS

## WITH T.C. INSERTS



**3109**  
**TOENNIS**  
Elastic pattern for  
dura-or intestinal suture  
180 mm



**3110**  
Cutting Plier  
12 cm



**3111**  
**MULLAR CLAUS**  
22 cm

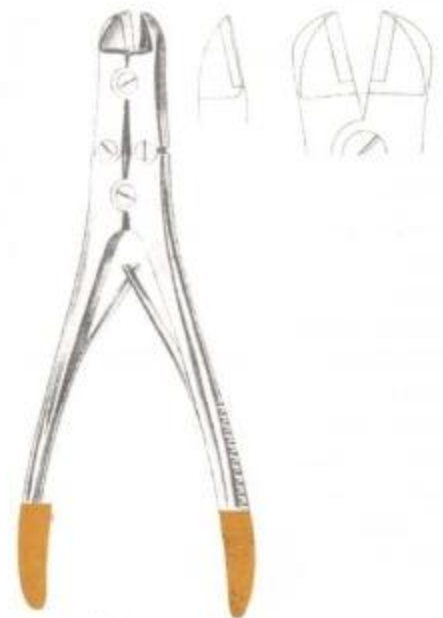

**3112**  
Plier  
17.5 cm

PARAMEDIC / UTILITY / EMT SHEAR

Sizes

4.5"  
5.5"  
7.25"



50-110

Sizes

4.5"  
5.5"  
7.25"



50-111

Sizes

4.5"  
5.5"  
7.25"



50-112

Sizes

4.5"  
5.5"  
7.25"



50-113

Sizes

4.5"  
5.5"  
7.25"



50-114

Sizes

4.5"  
5.5"  
7.25"



50-115

Sizes

4.5"  
5.5"  
7.25"



50-116

Sizes

4.5"  
5.5"  
7.25"



50-117

Sizes

4.5"  
5.5"  
7.25"



50-118

... ..



PARAMEDIC / UTILITY / EMT SHEAR



PARAMEDIC / UTILITY / EMT SHEAR

Sizes  
4.5"  
6"



Cutical scissors  
50-128

Sizes  
5.5"  
6.5"



Cutical scissors  
50-129

Sizes  
5.5"  
6.5"



Barber scissors  
50-130

Sizes  
5.5"  
6.5"



Thinning scissors  
50-131

Sizes  
5"



Barber scissors  
50-132

Sizes  
7"



Angular scissors  
50-133

Sizes  
5.5"



Bandage scissors  
50-134

Sizes  
5"



Dressing scissors  
50-135

## KEY RING



ART # 01



ART # 02



ART # 03



ART # 04



ART # 05



ART # 06



ART # 07



ART # 08

## KEY RING



ART # 09



ART # 10



ART # 11



ART # 12



ART # 13



ART # 14



ART # 15



ART # 16

## KEY RING



ART # 17



ART # 18



ART # 19



ART # 20



ART # 21



ART # 22

## KEY RING



ART # 23



ART # 24



ART # 25



ART # 26



ART # 27